

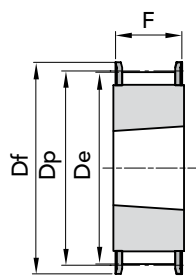

PULEGGE DENTATE HTD® TAPER LOCK® "FOSFATATE"

55

TIPO **5M 15**



ESEC. 1F

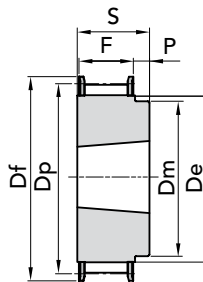

ESEC. 5F

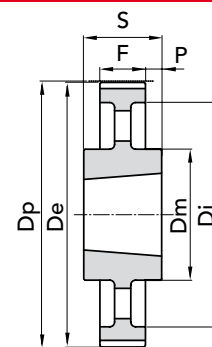

ESEC. 13

TIPO	CODICE	N. DENTI	ESEC.	BUSS.	FORO MAX	Dp	De	Df FLANGIA	Dm MOZZO	Ø Di	F	S	P	N. FLANGIA	Peso kg.
TL 34- 5M- 15	41215034	34	1F	1008	25	54,11	52,97	57	-	-	22	22	-	20	0,20
TL 36- 5M- 15	41215036	36	1F	1108	25	57,30	56,15	60	-	-	22	22	-	21	0,25
TL 38- 5M- 15	41215038	38	1F	1108	25	60,48	59,34	66,5	-	-	22	22	-	24	0,30
TL 40- 5M- 15	41215040	40	1F	1108	25	63,66	62,52	71	-	-	22	22	-	25	0,35
TL 44- 5M- 15	41215044	44	1F	1108	25	70,03	68,89	75	-	-	22	22	-	27	0,40
TL 48- 5M- 15	41215048	48	5F	1210	32	76,39	75,25	83	59	-	22	25	3	29	0,46
TL 56- 5M- 15	41215056	56	5F	1210	32	89,13	87,98	93	70	-	22	25	3	33	0,60
TL 64- 5M- 15	41215064	64	5F	1210	32	101,86	100,72	106	80	-	22	25	3	38	0,80
TL 72- 5M- 15	41215072	72	5	1610	42	114,59	113,45	-	92	-	22	25	3	-	1,20
TL 80- 5M- 15	41215080	80	5	1610	42	127,32	126,18	-	92	-	22	25	3	-	1,76
TL 90- 5M- 15	41215090	90	5	1610	42	143,24	142,10	-	92	-	22	25	3	-	2,32
TL 112- 5M- 15	41215112	112	5	2012	50	178,25	177,11	-	110	-	20	32	12	-	3,72
TL 136- 5M- 15	41215136	136	13	2012	50	216,45	215,31	-	110	199	20	32	6	-	3,82

MATERIALE **ACCIAIO**

Disegni CAD disponibili sul sito
www.chiaravalli.com

Quantità, disponibilità e prezzi
con B2B Chiaravalli



Le immagini non sono identificative del prodotto.

PULEGGE DENTATE HTD® TAPER LOCK® "FOSFATATE" 5M 15

PULEGGE DENTATE HTD® TAPER LOCK® "FOSFATATE"



PULEGGE DENTATE HTD® TAPER LOCK® "FOSFATATE" 8M 20

TIPO **8M 20**

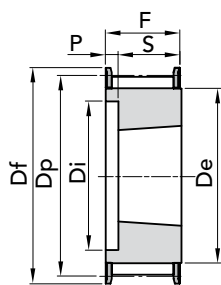

ESEC. 2F

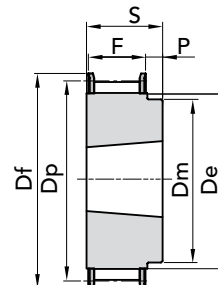

ESEC. 5F

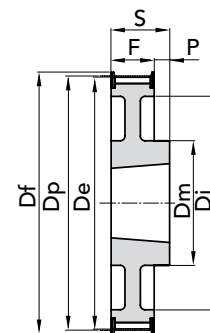

ESEC. 6F

TIPO	CODICE	N. DENTI	ESEC.	BUSS.	FORO MAX	Dp	De	Df	Dm	Ø Di	F	S	P	N. FLANGIA	Peso kg.	
											FLANGIA		MOZZO			
TL 22- 8M- 20	41420022	22	2F	1008	25	56,02	54,65	60	-	37	28	22	6	53	0,25	
TL 24- 8M- 20	41420024	24	2F	1108	28	61,12	59,75	66	-	44	28	22	6	69	0,30	
TL 26- 8M- 20	41420026	26	2F	1108	28	66,21	64,85	70	-	45	28	22	6	61	0,36	
TL 28- 8M- 20	41420028	28	2F	1108	28	71,30	70,08	75	-	50	28	22	6	79	0,45	
TL 30- 8M- 20	41420030	30	2F	1108	28	76,39	75,13	82,5	-	58	28	22	6	73	0,55	
TL 32- 8M- 20	41420032	32	2F	1610	42	81,49	80,16	87	-	63	28	25	3	76	0,43	
TL 34- 8M- 20	41420034	34	2F	1610	42	86,58	85,22	91	-	64	28	25	3	66	0,57	
TL 36- 8M- 20	41420036	36	2F	1610	42	91,67	90,30	97	-	68	28	25	3	68	0,70	
TL 38- 8M- 20	41420038	38	2F	1610	42	96,77	95,39	102	-	72	28	25	3	70	0,82	
TL 40- 8M- 20	41420040	40	2F	1610	42	101,86	100,49	106	-	76	28	25	3	77	1,10	
TL 44- 8M- 20	41420044	44	5F	2012	50	112,05	110,67	120	92	-	28	32	4	75	1,20	
TL 48- 8M- 20	41420048	48	5F	2012	50	122,23	120,86	128	96	-	28	32	4	78	1,65	
TL 56- 8M- 20	41420056	56	5F	2012	50	142,60	141,23	150	110	-	28	32	4	85	2,50	
TL 64- 8M- 20	41420064	64	6F	2012	50	162,97	161,60	168	110	137	28	32	4	90	2,60	
TL 72- 8M- 20	41420072	72	6F	2012	50	183,35	181,97	192	110	158	28	32	4	97	3,40	
TL 80- 8M- 20	41420080	80	7	2012	50	203,72	202,35	-	110	180	28	32	4	-	3,60	
TL 90- 8M- 20	41420090	90	7	2012	50	229,18	227,81	-	110	204	28	32	4	-	4,10	
TL 112-8M- 20	41420112	112	7	2517	60	285,21	283,83	-	125	254	28	45	17	-	4,57	
TL 144- 8M- 20	41420144	144	13	2517	60	366,69	365,32	-	125	336	28	45	12	-	5,00	

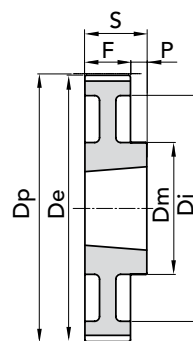

ESEC. 7

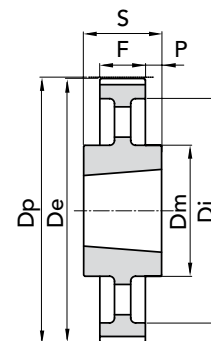

ESEC. 13

MATERIALE **ACCIAIO**

MATERIALE **GHISA**

Disegni CAD disponibili sul sito
www.chiaravalli.com

Quantità, disponibilità e prezzi
con B2B Chiaravalli



PULEGGE DENTATE HTD® TAPER LOCK® "FOSFATATE"

TIPO 8M 30

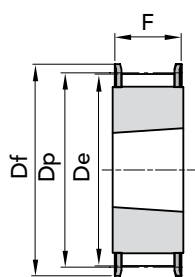

ESEC. 1F

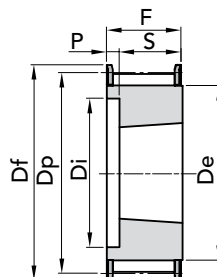

ESEC. 2F

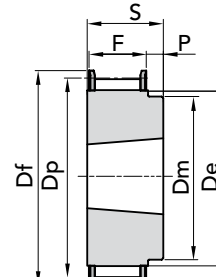

ESEC. 5F

TIPO	CODICE	N. DENTI	ESEC.	BUSS.	FORO MAX	Dp	De	Df	Dm	Ø Di	F	S	P	N. FLANGIA	Peso kg.
TL 22- 8M- 30	41430022	22	2F	1008	28	56,02	54,65	60	-	37	38	22	16	53	0,33
TL 24- 8M- 30	41430024	24	2F	1108	28	61,12	59,75	66	-	44	38	22	16	69	0,40
TL 26- 8M- 30	41430026	26	2F	1108	28	66,21	64,85	70	-	44	38	22	16	61	0,45
TL 28- 8M- 30	41430028	28	2F	1210	32	71,30	70,08	75	-	50	38	25	13	79	0,50
TL 30- 8M- 30	41430030	30	1F	1615	42	76,39	75,13	82,5	-	-	38	38	-	73	0,55
TL 32- 8M- 30	41430032	32	1F	1615	42	81,49	80,16	87	-	-	38	38	-	76	0,60
TL 34- 8M- 30	41430034	34	1F	1615	42	86,58	85,22	91	-	-	38	38	-	66	0,80
TL 36- 8M- 30	41430036	36	1F	1615	42	91,57	90,30	97	-	-	38	38	-	68	1,00
TL 38- 8M- 30	41430038	38	1F	1615	42	96,77	95,39	102	-	-	38	38	-	70	1,10
TL 40- 8M- 30	41430040	40	1F	1615	42	101,86	100,49	106	-	-	38	38	-	77	1,34
TL 44- 8M- 30	41430044	44	2F	2012	50	112,05	110,67	120	-	86	38	32	6	75	1,30
TL 48- 8M- 30	41430048	48	2F	2012	50	122,23	120,86	128	-	90	38	32	6	78	1,80
TL 56- 8M- 30	41430056	56	2F	2012	50	142,60	141,23	150	-	110	38	32	6	85	3,80
TL 64- 8M- 30	41430064	64	5F	2517	60	162,97	161,60	168	125	-	38	45	7	90	4,30
TL 72- 8M- 30	41430072	72	6F	2517	60	183,35	181,97	192	125	158	38	45	7	97	4,40
TL 80- 8M- 30	41430080	80	7	2517	60	203,72	202,35	-	125	180	38	45	7	-	4,65
TL 90- 8M- 30	41430090	90	7	2517	60	229,18	227,81	-	125	204	38	45	7	-	5,80
TL 112-8M- 30	41430112	112	7	2517	60	285,21	283,83	-	125	254	38	45	7	-	6,20
TL 144- 8M- 30	41430144	144	8	2517	60	366,69	365,32	-	125	336	38	45	7	-	9,00
TL 168- 8M- 30	41430168	168	8	2517	60	427,81	426,44	-	125	395	38	45	7	-	11,80
TL 192- 8M- 30	41430192	192	8	3525	60	488,92	487,55	-	125	455	38	45	7	-	14,00

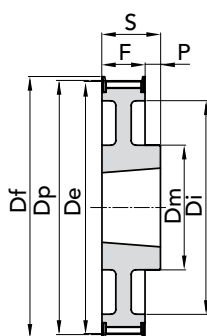

ESEC. 6F

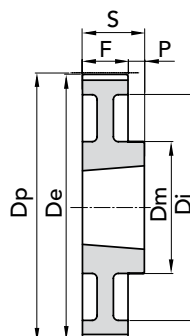

ESEC. 7

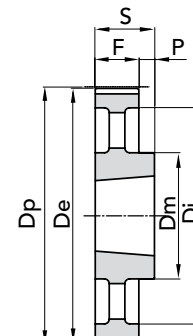

ESEC. 8

MATERIALE ACCIAIO

MATERIALE GHISA

Disegni CAD disponibili sul sito
www.chiaravalli.com

Quantità, disponibilità e prezzi
con B2B Chiaravalli



Le immagini non sono identificative del prodotto.

PULEGGE DENTATE HTD® TAPER LOCK® "FOSFATATE" 8M 30

PULEGGE DENTATE HTD® TAPER LOCK® "FOSFATATE"



PULEGGE DENTATE HTD® TAPER LOCK® "FOSFATATE" 8M 50

TIPO **8M 50**

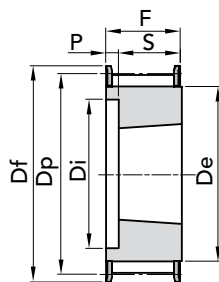

ESEC. 2F

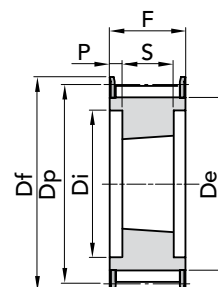

ESEC. 3F

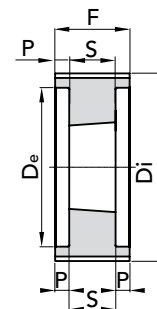

ESEC. 4

TIPO	CODICE	N. DENTI	ESEC.	BUSS.	FORO MAX	Dp	De	Df	Dm	Ø Di	F	S	P	N. FLANGIA	Peso kg.
TL 28- 8M- 50	41450028	28	2F	1210	32	71,30	70,08	75	-	50	60	25	35	79	0,60
TL 30- 8M- 50	41450030	30	2F	1615	42	76,39	75,13	82,5	-	58	60	38	22	73	0,65
TL 32- 8M- 50	41450032	32	2F	1615	42	81,49	80,16	87	-	63	60	38	22	76	0,80
TL 34- 8M- 50	41450034	34	2F	1615	42	86,58	85,22	91	-	65	60	38	22	66	1,08
TL 36- 8M- 50	41450036	36	2F	1615	42	91,67	90,30	97	-	68	60	38	22	68	1,35
TL 38- 8M- 50	41450038	38	2F	1615	42	96,77	95,39	102	-	72	60	38	22	70	1,65
TL 40- 8M- 50	41450040	40	3F	2012	50	101,86	100,49	106	-	80	60	32	14	77	1,70
TL 44- 8M- 50	41450044	44	3F	2012	50	112,05	110,67	120	-	86	60	32	14	75	1,80
TL 48- 8M- 50	41450048	48	3F	2012	50	122,23	120,86	128	-	95	60	32	14	78	2,35
TL 56- 8M- 50	41450056	56	3F	2517	60	142,60	141,23	150	-	116	60	45	7,5	85	3,35
TL 64- 8M- 50	41450064	64	3F	2517	60	162,97	161,60	168	-	136	60	45	7,5	90	4,90
TL 72- 8M- 50	41450072	72	10F	2517	60	183,35	181,97	192	125	158	60	45	7,5	97	6,90
TL 80- 8M- 50	41450080	80	4	3020	75	203,72	202,30	-	-	180	60	51	4,5	-	8,90
TL 90- 8M- 50	41450090	90	11	3020	75	229,18	227,81	-	160	204	60	51	4,5	-	9,90
TL 112- 8M- 50	41450112	112	11	3020	75	285,21	283,83	-	170	254	60	51	4,5	-	12,10
TL 144- 8M- 50	41450144	144	12	3020	75	366,69	365,32	-	170	336	60	51	4,5	-	15,40
TL 168- 8M- 50	41450168	168	13	3525	90	427,81	426,44	-	198	395	60	65	2,5	-	22,80
TL 192- 8M- 50	41450192	192	13	3525	90	488,92	487,55	-	198	455	60	65	2,5	-	26,50

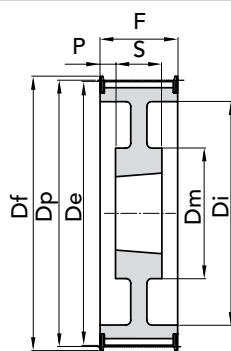

ESEC. 10F

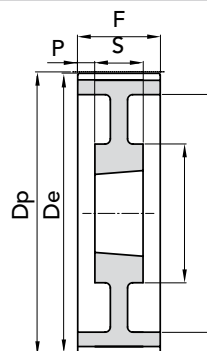

ESEC. 11

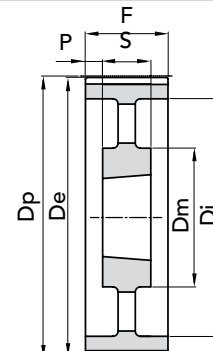

ESEC. 12

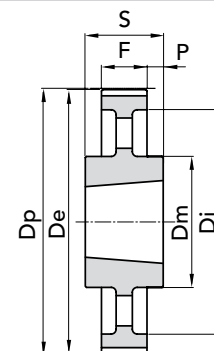

ESEC. 13

MATERIALE **ACCIAIO**

MATERIALE **GHISA**

Disegni CAD disponibili sul sito
www.chiaravalli.com

Quantità, disponibilità e prezzi
con B2B Chiaravalli



PULEGGE DENTATE HTD® TAPER LOCK® "FOSFATATE"

TIPO 8M 85

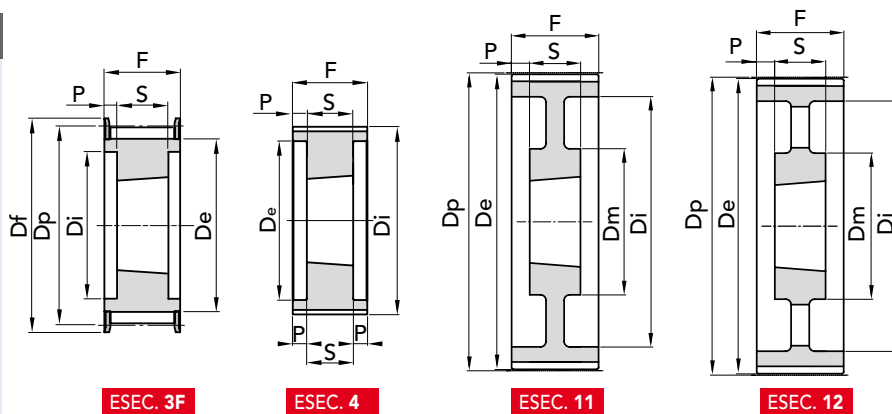

ESEC. 3F

ESEC. 4

ESEC. 11

ESEC. 12

TIPO	CODICE	N. DENTI	ESEC.	BUSS.	FORO MAX	Dp	De	Df FLANGIA	Dm MOZZO	Ø Di	F	S	P	N. FLANGIA	Peso kg.
TL 34- 8M- 85	41485034	34	3F	1615	42	86,58	85,22	91	-	65	95	38	28,5	66	1,50
TL 36- 8M- 85	41485036	36	3F	1615	42	91,67	90,30	97	-	68	95	38	28,5	68	1,90
TL 38- 8M- 85	41485038	38	3F	1615	42	96,77	95,39	102	-	72	95	38	28,5	70	2,20
TL 40- 8M- 85	41485040	40	3F	2012	50	101,86	100,49	106	-	80	95	32	31,5	77	1,90
TL 44- 8M- 85	41485044	44	3F	2012	50	112,05	110,67	120	-	86	95	32	31,5	75	2,30
TL 48- 8M- 85	41485048	48	3F	2517	60	122,23	120,86	128	-	97	95	45	25	78	2,70
TL 56- 8M- 85	41485056	56	3F	2517	60	142,60	141,23	150	-	116	95	45	25	85	4,50
TL 64- 8M- 85	41485064	64	3F	2517	60	162,97	161,60	168	-	136	95	45	25	90	6,30
TL 72- 8M- 85	41485072	72	3F	3020	75	183,35	181,97	192	-	150	95	51	22	97	8,10
TL 80- 8M- 85	41485080	80	4	3020	75	203,72	202,35	-	-	180	95	51	22	-	10,20
TL 90- 8M- 85	41485090	90	4	3020	75	229,18	227,81	-	-	204	95	51	22	-	11,20
TL 112- 8M- 85	41485112	112	11	3020	75	285,21	283,83	-	170	254	95	51	22	-	15,00
TL 144- 8M- 85	41485144	144	11	3525	90	366,69	365,32	-	198	336	95	65	15	-	20,20
TL 168- 8M- 85	41485168	168	12	3525	90	427,81	426,44	-	198	395	95	65	15	-	22,40
TL 192- 8M- 85	41485192	192	12	3525	90	488,92	487,55	-	198	455	95	65	15	-	28,20

PULEGGE DENTATE HTD® TAPER LOCK® "FOSFATATE" 8M 85

MATERIALE ACCIAIO

MATERIALE GHISA

Disegni CAD disponibili sul sito
www.chiaravalli.com

Quantità, disponibilità e prezzi
con B2B Chiaravalli

PULEGGE DENTATE HTD® TAPER LOCK® "FOSFATATE"



PULEGGE DENTATE HTD® TAPER LOCK® "FOSFATATE" 14M 40

TIPO **14M 40**

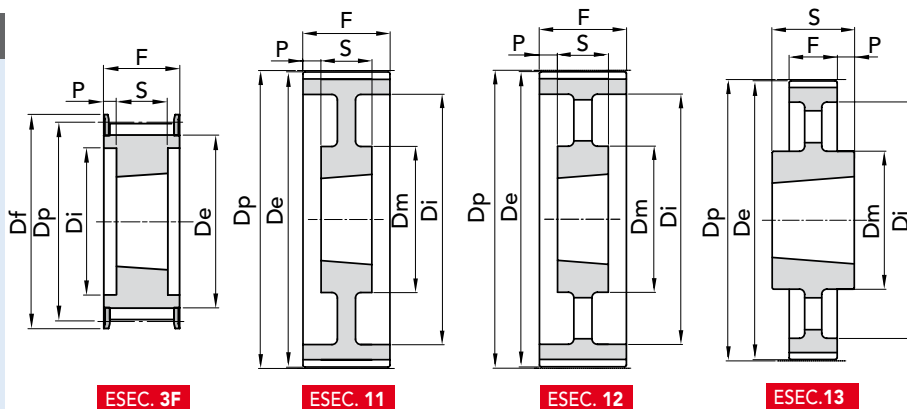

TIPO	CODICE	N. DENTI	ESEC.	BUSS.	FORO MAX	Dp	De	Df	Dm	Ø Di	F	S	P	N. FLANGIA	Peso kg.
TL 28-14M- 40	41640028	28	3F	2012	50	124,78	122,12	128	-	94	54	32	11	153	2,10
TL 29-14M- 40	41640029	29	3F	2012	50	129,23	126,57	138	-	96	54	32	11	154	2,40
TL 30-14M- 40	41640030	30	3F	2012	50	133,69	139,99	138	-	98	54	32	11	154	2,70
TL 32-14M- 40	41640032	32	3F	2012	50	142,60	139,88	154	-	108	54	32	11	160	3,40
TL 34-14M- 40	41640034	34	3F	2517	60	151,52	148,79	160	-	110	54	45	4,5	166	3,90
TL 36-14M- 40	41640036	36	3F	2517	60	160,43	157,68	168	-	120	54	45	4,5	168	4,80
TL 38-14M- 40	41640038	38	3F	2517	60	169,34	166,60	183	-	130	54	45	4,5	172	5,40
TL 40-14M- 40	41640040	40	3F	2517	60	178,25	175,49	188	-	138	54	45	4,5	162	6,00
TL 42-14M- 40	41640042	42	3F	3020	75	187,16	184,37	200	-	147	54	51	1,5	SP	7,50
TL 44-14M- 40	41640044	44	3F	3020	75	196,08	193,28	211	-	155	54	51	1,5	175	9,00
TL 48-14M- 40	41640048	48	3F	3020	75	213,90	211,11	226	-	170	54	51	1,5	180	10,10
TL 56-14M- 40	41640056	56	3F	3020	75	249,55	246,76	256	-	208	54	51	1,5	182	13,40
TL 72-14M- 40	41640072	72	11	3020	75	320,86	318,06	-	170	280	54	51	1,5	-	15,00
TL 80-14M- 40	41640080	80	12	3020	75	356,51	353,71	-	170	315	54	51	1,5	-	16,00
TL 90-14M- 40	41640090	90	12	3020	75	401,70	398,28	-	170	360	54	51	1,5	-	18,00
TL 112-14M- 40	41640112	112	12	3020	75	499,11	496,32	-	170	457	54	51	1,5	-	25,50
TL 144-14M- 40	41640144	144	12	3020	75	641,71	638,92	-	170	600	54	51	1,5	-	32,00
TL 168-14M- 40	41640168	168	12	3020	75	748,66	745,87	-	170	706	54	51	1,5	-	53,60
TL 192-14M- 40	41640192	192	12	3020	75	855,62	852,82	-	170	813	54	51	1,5	-	65,40
TL 216-14M- 40	41640216	216	12	3020	75	962,57	959,76	-	170	920	54	51	1,5	-	87,30
TL 264-14M- 40	41640264	264	13	4040	100	1176,47	1173,66	-	230	1133	54	102	24	-	131,0

MATERIALE **ACCIAIO**

MATERIALE **GHISA**

Disegni CAD disponibili sul sito
www.chiaravalli.com

Quantità, disponibilità e prezzi
con B2B Chiaravalli





PULEGGE DENTATE HTD® TAPER LOCK® "FOSFATATE"

61

TIPO 14M 55

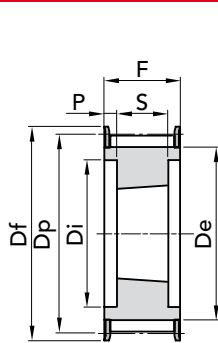

ESEC. 3F

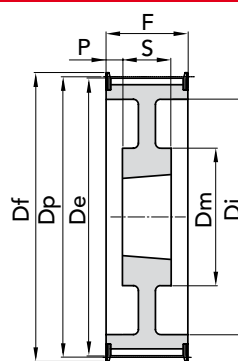

ESEC. 10F

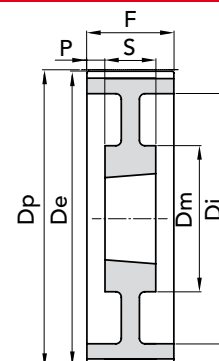

ESEC. 11

TIPO	CODICE	N. DENTI	ESEC.	BUSS.	FORO MAX	Dp	De	Df	Dm	Ø Di	F	S	P	N. FLANGIA	Peso kg.
						FLANGIA		MOZZO							
TL 28-14M- 55	41655028	28	3F	2012	50	124,78	122,12	128	-	94	70	32	19	153	2,20
TL 29-14M- 55	41655029	29	3F	2012	50	129,23	126,57	138	-	100	70	32,0	19	154	2,50
TL 30-14M- 55	41655030	30	3F	2517	60	133,69	130,99	138	-	100	70	45	12,5	154	2,70
TL 32-14M- 55	41655032	32	3F	2517	60	142,60	139,88	154	-	108	70	45	12,5	160	3,60
TL 34-14M- 55	41655034	34	3F	2517	60	151,52	148,79	160	-	110	70	45	12,5	166	4,50
TL 36-14M- 55	41655036	36	3F	2517	60	160,43	157,68	168	-	120	70	45	12,5	168	5,20
TL 38-14M- 55	41655038	38	3F	2517	60	169,34	166,60	183	-	130	70	45	12,5	172	6,20
TL 40-14M- 55	41655040	40	3F	2517	60	178,25	175,49	188	-	138	70	45	12,5	162	7,00
TL 42-14M- 55	41655042	42	3F	3020	75	187,16	184,37	200	-	147	70	51	9,5	SP	8,00
TL 44-14M- 55	41655044	44	3F	3020	75	196,08	193,28	211	-	155	70	51	9,5	175	8,60
TL 48-14M- 55	41655048	48	3F	3020	75	213,90	211,11	226	-	170	70	51	9,5	180	11,00
TL 56-14M- 55	41655056	56	3F	3020	75	249,55	246,76	256	-	208	70	51	9,5	182	13,50
TL 64-14M- 55	41655064	64	10F	3020	75	285,21	282,41	296	170	240	70	51	9,5	184	14,50
TL 72-14M- 55	41655072	72	11	3020	75	320,86	318,06	-	170	280	70	51	9,5	-	16,30
TL 80-14M- 55	41655080	80	12	3020	75	356,51	353,71	-	170	315	70	51	9,5	-	17,50
TL 90-14M- 55	41655090	90	12	3020	75	401,07	398,28	-	170	360	70	51	9,5	-	20,00
TL 112-14M- 55	41655112	112	12	3020	75	499,11	496,32	-	170	457	70	51	9,5	-	28,20
TL 144-14M- 55	41655144	144	12	3020	75	641,71	638,92	-	170	600	70	51	9,5	-	36,00
TL 168-14M- 55	41655168	168	12	3020	75	748,66	745,87	-	170	706	70	51	9,5	-	48,50
TL 192-14M- 55	41655192	192	12	3020	75	855,62	852,82	-	170	813	70	51	9,5	-	52,00
TL 216-14M- 55	41655216	216	13	3535	90	962,57	959,76	-	190	920	70	89	9,5	-	59,00
TL 264-14M- 55	41655264	264	13	4040	100	1176,47	1173,66	-	230	1133	70	102	16	-	78,00

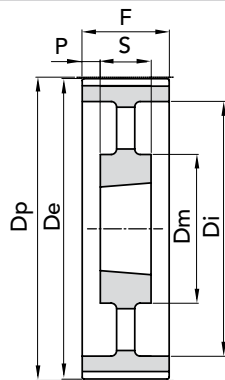

ESEC. 12

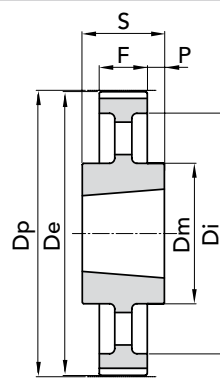

ESEC. 13



Le immagini non sono identificative del prodotto.

Disegni CAD disponibili sul sito www.chiaravalli.com

Quantità, disponibilità e prezzi con B2B Chiaravalli

PULEGGE DENTATE HTD® TAPER LOCK® "FOSFATATE"



PULEGGE DENTATE HTD® TAPER LOCK® "FOSFATATE" 14M 85

TIPO **14M 85**

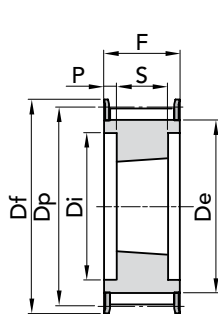

ESEC. 3F

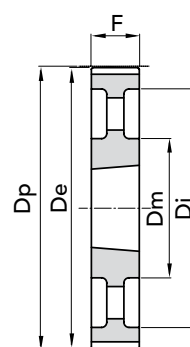

ESEC. 9

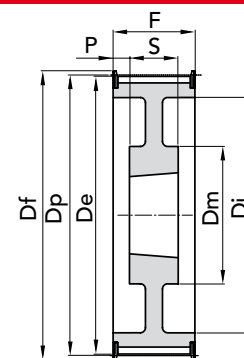

ESEC. 10F

TIPO	CODICE	N. DENTI	ESEC.	BUSS.	FORO MAX	Dp	De	Df	Dm	Ø Di	F	S	P	N. FLANGIA	Peso kg.
						FLANGIA			MOZZO						
TL 28-14M- 85	41685028	28	3F	2517	60	124,78	122,12	128	-	98	102	45	28,5	153	2,70
TL 29-14M- 85	41685029	29	3F	2517	60	129,23	126,57	138	-	100	102	45	28,5	154	3,50
TL 30-14M- 85	41685030	30	3F	2517	60	133,69	130,99	138	-	100	102	45	28,5	154	3,80
TL 32-14M- 85	41685032	32	3F	2517	60	142,60	139,88	154	-	108	102	45	28,5	160	4,70
TL 34-14M- 85	41685034	34	3F	2517	60	151,52	148,79	160	-	110	102	45	28,5	166	6,00
TL 36-14M- 85	41685036	36	3F	3020	75	160,43	157,68	168	-	125	102	51	25,5	168	5,70
TL 38-14M- 85	41685038	38	3F	3020	75	169,34	166,60	183	-	130	102	51	25,5	172	6,80
TL 40-14M- 85	41685040	40	3F	3020	75	178,25	175,49	188	-	138	102	51	25,5	162	8,00
TL 44-14M- 85	41685044	44	3F	3020	75	196,08	193,28	211	-	153	102	51	25,5	175	11,70
TL 48-14M- 85	41685048	48	3F	3020	75	213,90	211,11	226	-	171	102	51	25,5	180	15,00
TL 56-14M- 85	41685056	56	3F	3525	90	249,55	246,76	256	-	210	102	65	18,5	182	19,00
TL 64-14M- 85	41685064	64	10F	3525	90	285,21	282,41	296	190	240	102	65	18,5	184	24,00
TL 72-14M- 85	41685072	72	11	3525	90	320,86	318,06	-	190	280	102	65	18,5	-	25,00
TL 80-14M- 85	41685080	80	12	3525	90	356,51	353,71	-	190	315	102	65	18,5	-	26,00
TL 90-14M- 85	41685090	90	12	3525	90	401,70	398,28	-	190	360	102	65	18,5	-	28,00
TL 112-14M- 85	41685112	112	12	3525	90	499,11	496,32	-	190	457	102	65	18,5	-	36,00
TL 144-14M- 85	41685144	144	12	3525	90	641,71	638,92	-	190	600	102	65	18,5	-	48,00
TL 168-14M- 85	41685168	168	12	3525	90	748,66	745,87	-	190	706	102	65	18,5	-	60,00
TL 192-14M- 85	41685192	192	9	4040	100	855,62	852,82	-	230	813	102	102	-	-	85,00
TL 216-14M- 85	41685216	216	9	4040	100	962,57	959,76	-	230	920	102	102	-	-	91,50
TL 264-14M- 85	41685264	264	9	4040	100	1176,47	1173,66	-	230	1133	102	102	-	-	145,00

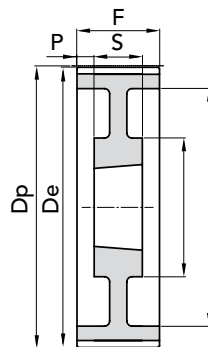

ESEC. 11

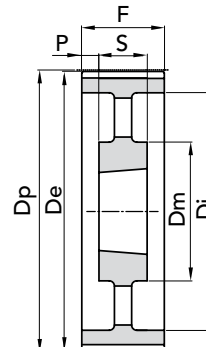

ESEC. 12



MATERIALE **ACCIAIO**

MATERIALE **GHISA**

Disegni CAD disponibili sul sito
www.chiaravalli.com

Quantità, disponibilità e prezzi
con B2B Chiaravalli



PULEGGE DENTATE HTD® TAPER LOCK® "FOSFATATE"

TIPO 14M 115

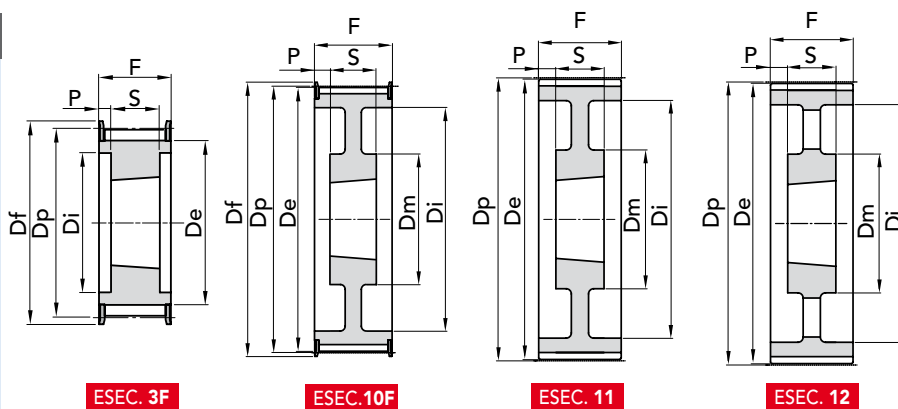

ESEC. 3F

ESEC. 10F

ESEC. 11

ESEC. 12

TIPO	CODICE	N. DENTI	ESEC.	BUSS.	FORO MAX	Dp	De	Df	Dm	Ø Di	F	S	P	N. FLANGIA	Peso kg.
TL 28-14M-115	41690028	28	3F	2517	60	124,78	122,12	128	-	98	133	45	44	153	3,80
TL 29-14M-115	a richiesta	29	3F	2517	60	129,23	126,57	138	-	100	133	45	44	154	-
TL 30-14M-115	41690030	30	3F	2517	60	133,69	130,99	138	-	100	133	45	44	154	5,00
TL 32-14M-115	41690032	32	3F	2517	60	142,60	139,88	154	-	108	133	45	44	160	6,80
TL 34-14M-115	41690034	34	3F	2517	60	151,52	148,79	160	-	110	133	45	44	166	6,90
TL 36-14M-115	41690036	36	3F	3020	75	160,43	157,68	168	-	125	133	51	41	168	7,00
TL 38-14M-115	41690038	38	3F	3020	75	169,34	166,60	183	-	130	133	51	41	172	8,50
TL 40-14M-115	41690040	40	3F	3020	75	178,25	175,49	188	-	138	133	51	41	162	9,10
TL 44-14M-115	41690044	44	3F	3030	75	196,08	193,28	211	-	155	133	76	28,5	175	13,00
TL 48-14M-115	41690048	48	3F	3030	75	213,90	211,11	226	-	170	133	76	28,5	180	16,00
TL 56-14M-115	41690056	56	3F	3535	90	249,55	246,76	256	-	210	133	89	22	182	24,00
TL 64-14M-115	41690064	64	10F	3535	90	285,21	282,41	296	190	240	133	89	22	184	32,00
TL 72-14M-115	41690072	72	11	3535	90	320,86	318,06	-	190	280	133	89	22	-	31,00
TL 80-14M-115	41690080	80	12	3535	90	356,51	353,71	-	190	315	133	89	22	-	32,00
TL 90-14M-115	41690090	90	12	3535	90	401,07	398,28	-	190	360	133	89	22	-	37,00
TL 112-14M-115	41690112	112	12	3535	90	499,11	496,32	-	190	457	133	89	22	-	45,00
TL 144-14M-115	41690144	144	12	4040	100	641,71	638,92	-	230	600	133	102	15,5	-	63,00
TL 168-14M-115	41690168	168	12	4040	100	748,66	745,87	-	230	706	133	102	15,5	-	77,50
TL 192-14M-115	41690192	192	12	4040	100	855,62	852,82	-	230	813	133	102	15,5	-	95,00
TL 216-14M-115	a richiesta	216	12	4040	100	962,57	959,76	-	230	920	133	102	15,5	-	-
TL 264-14M-115	41690264	264	12	5050	125	1176,47	1173,66	-	270	1133	133	127	3	-	120,0

PULEGGE DENTATE HTD® TAPER LOCK® "FOSFATATE" 14M 115

MATERIALE ACCIAIO

MATERIALE GHISA

Disegni CAD disponibili sul sito
www.chiaravalli.com

Quantità, disponibilità e prezzi
con B2B Chiaravalli



Le immagini non sono identificative del prodotto.

PULEGGE DENTATE HTD® TAPER LOCK® "FOSFATATE"



PULEGGE DENTATE HTD® TAPER LOCK® "FOSFATATE" 14M 170

TIPO **14M 170**

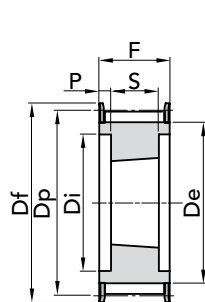

ESEC. 3F

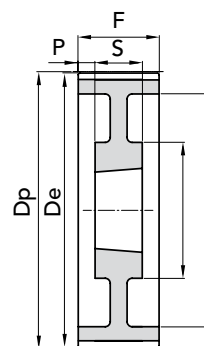

ESEC. 11

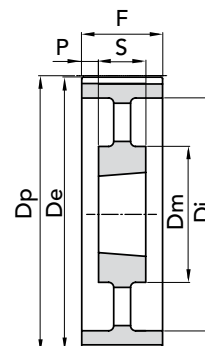

ESEC. 12

TIPO	CODICE	N. DENTI	ESEC.	BUSS.	FORO MAX	Dp	De	Df	Dm	Ø Di	F	S	P	N. FLANGIA	Peso kg.
								FLANGIA	MOZZO						
TL 38-14M-170	41692038	38	3F	3030	75	169,34	166,60	183	-	130	187	76	55,5	172	11,70
TL 40-14M-170	41692040	40	3F	3030	75	178,25	175,49	188	-	138	187	76	55,5	162	13,00
TL 44-14M-170	41692044	44	3F	3535	90	196,08	193,28	211	-	155	187	89	49	175	15,00
TL 48-14M-170	41692048	48	3F	3535	90	213,90	211,11	226	-	175	187	89	49	180	19,00
TL 56-14M-170	41692056	56	3F	3535	90	249,55	246,76	256	-	210	187	89	49	182	28,50
TL 64-14M-170	a richiesta	64	3F	4040	100	285,21	282,41	296	-	240	187	102	42,5	184	
TL 72-14M-170	a richiesta	72	11	4040	100	320,86	318,06	-	230	280	187	102	42,5	-	-
TL 80-14M-170	41692080	80	11	4040	100	356,51	353,71	-	230	315	187	102	42,5	-	48,00
TL 90-14M-170	41692090	90	12	4040	100	401,07	398,28	-	230	360	187	102	42,5	-	52,50
TL 112-14M-170	41692112	112	12	5050	125	499,11	496,32	-	265	457	187	127	30	-	74,50
TL 144-14M-170	41692144	144	12	5050	125	641,71	638,92	-	265	600	187	127	30	-	91,00
TL 168-14M-170	41692168	168	12	5050	125	748,66	745,87	-	265	706	187	127	30	-	116,00
TL 192-14M-170	a richiesta	192	12	5050	125	855,62	852,82	-	265	813	187	127	30	-	-
TL 216-14M-170	a richiesta	216	12	5050	125	962,57	959,76	-	265	920	187	127	30	-	-

MATERIALE **ACCIAIO**

MATERIALE **GHISA**

Disegni CAD disponibili sul sito
www.chiaravalli.com

Quantità, disponibilità e prezzi
con B2B Chiaravalli

