

Price list €

2011

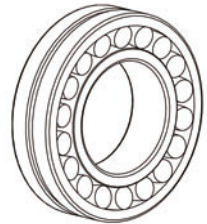
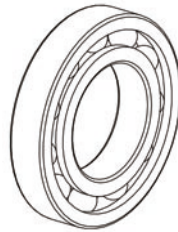
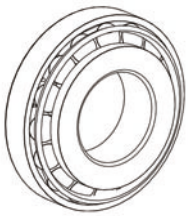

Preisliste

Tarif

Listino

Listas de Precios

Prijislijst

Hintalista

Lista de Peças

Prisliste

Prislista

Prisliste

® SKF and CARB are registered trademarks of the SKF Group.

© SKF Group 2011

The contents of this publication are the copyright of the publisher and may not be reproduced (even extracts) unless written permission is granted. Every care has been taken to ensure the accuracy of the information contained in this publication, but no liability can be accepted for any loss or damage whether direct, indirect or consequential arising out of the use of the information contained herein.

Publication **6862 EN** · Januari 2011

Printed in Sweden on environmentally friendly paper.

Foreword	13
Deep groove ball bearings	19
Self-aligning ball bearings	33
Angular contact ball bearings	37
Taper roller bearings	45
Inch-size taper roller bearings	49
Cylindrical roller bearings	53
Spherical roller bearings	63
CARB®	69
Thrust ball bearings	73
Spherical roller thrust bearings	79
Y-Bearings	81
SKF ConCentra	107
Housings	109
Accessories	129
Needle roller bearings	139
Needle roller thrust bearings	153
Cylindrical roller thrust bearings	155
Track Runner bearings	159
Plain bearings	167
High Precision Bearings	175
Index	181

13	Vorwort
19	Rillenkugellager
33	Pendelkugellager
37	Schrägkugellager
45	Kegelrollenlager
49	Kegelrollenlager mit Zollabmessungen
53	Zylinderrollenlager
63	Pendelrollenlager
69	CARB®
73	Axial-Rillenkugellager
79	Axial-Pendelrollenlager
81	Y-Lager
107	SKF ConCentra-Rollenlagereinheiten
109	Lagergehäuse
129	Zubehör
139	Nadellager
153	Axial-Nadellager
155	Axial-Zylinderrollenlager
159	Lauf-, Stütz- und Kurvenrollen
167	Gleitlager
175	Hochgenauigkeitslager
181	Index

Avant-propos	13
Roulements rigides à billes	19
Roulements à rotule sur billes	33
Roulements à billes à contact oblique	37
Roulements à rouleaux coniques	45
Roulements à rouleaux coniques à cotes en pouces	49
Roulements à rouleaux cylindriques	53
Roulements à rotule sur rouleaux	63
CARB®	69
Butées à billes	73
Butées à rotule sur rouleaux	79
Roulements Y	81
SKF Concentra	107
Paliers	109
Accessoires	129
Roulements à aiguilles	139
Butées à aiguilles	153
Butées à rouleaux cylindriques	155
Galets	159
Rotules	167
Roulements de haute précision	175
Index	181

13	Avvertenza
19	Cuscinetti radiali a sfere
33	Cuscinetti orientabili a sfere
37	Cuscinetti obliqui a sfere
45	Cuscinetti a rulli conici
49	Cuscinetti a rulli conici in pollici
53	Cuscinetti a rulli cilindrici
63	Cuscinetti orientabili a rulli
69	CARB®
73	Cuscinetti assiali a sfere
79	Cuscinetti assiali orientabili a rulli
81	Cuscinetti Y
107	SKF ConCentra
109	Sopporti
129	Accessori
139	Cuscinetti a rullini
153	Cuscinetti assiali a rullini
155	Cuscinetti assiali a rulli cilindrici
159	Rotelle
167	Snodi sferici
175	Cuscinetti di precisione
181	Indice

Prólogo	13
Rodamientos rígidos de bolas	19
Rodamientos de bolas a rótula	33
Rodamientos de bolas con contacto angular	37
Rodamientos de rodillos cónicos	45
Rodamientos de rodillos cónicos en pulgadas	49
Rodamientos de rodillos cilíndricos	53
Rodamientos de rodillos a rótula	63
CARB®	69
Rodamientos axiales de bolas	73
Rodamientos axiales de rodillos a rótula	79
Rodamientos Y	81
SKF Concentra	107
Soportes	109
Accesorios	129
Rodamientos de agujas	139
Rodamientos axiales de agujas	153
Rodamientos axiales de rodillos cilíndricos	155
Roldanas	159
Cojinetes lisos	167
Rodamientos de alta precisión	175
Índice	181

13	Voorwoord
19	Groefkogellagers
33	Tweerijige zich instellende kogellagers
37	Hoekcontactkogellagers
45	Kegellagers
49	Kegellagers in inch maten
53	Cilinderlagers
63	Tweerijige tonlagers
69	CARB®
73	Axiale kogellagers
79	Tontaatslagers
81	Y-lagers
107	SKF ConCentra
109	Lagerhuizen
129	Toebehoren
139	Naaldlagers
153	Naaldtaatslagers
155	Cilindertaatslagers
159	Loop-, steun- en nokrollen
167	Glijlagers
175	Hoge-precisielagers
181	Index

Johdanto	13
Urakuulalaakerit	19
Pallomaiset kuulalaakerit	33
Viistokuulalaakerit	37
Kartiorullalaakerit	45
Tuumamittaiset kartiorullalaakerit	49
Lieriörullalaakerit	53
Pallomaiset rullalaakerit	63
CARB®	69
Painekuulalaakerit	73
Pallomaiset painerullalaakerit	79
Y-laakerit	81
SKF ConCentra	107
Laakeripesät	109
Tarvikkeet	129
Neulalaakerit	139
Paineneulalaakerit	153
Lieriömäiset painerullalaakerit	155
Juoksu-, tuki- ja nokkarullat	159
Nivellaakerit	167
Tarkkuuslaakerit	175
Index	181

13	Introdução
19	Rolamentos rígidos de esferas
33	Rolamentos autocompensadores de esferas
37	Rolamentos de esferas de contato angular
45	Rolamentos de rolos cónicos
49	Rolamentos de rolos cónicos em polegadas
53	Rolamentos de rolos cilíndricos
63	Rolamentos autocompensadores de rolos
69	CARB®
73	Rolamentos axiais de esferas
79	Rolamentos axiais autocompensadores de rolos
81	Rolamentos Y
107	SKF ConCentra
109	Chumaceiras
129	Acessórios
139	Rolamentos de agulhas
153	Rolamentos axiais de agulhas
155	Rolamentos axiais de rolos cilíndricos
159	Rolos de leva e de apoio
167	Rótulas
175	Rolamentos de alta precisão
181	Índice

Forord	13
Sporkuglelejer	19
Sfæriske kuglelejer	33
Vinkelkontaktkuglelejer	37
Koniske rullelejer	45
Koniske rullelejer i tommemål	49
Cylindriske rullelejer	53
Sfæriske rullelejer	63
CARB®	69
Aksialkuglelejer	73
Sfæriske aksialrullelejer	79
Y-lejer	81
SKF ConCentra lejeenheder	107
Lejehuse	109
Tilbehør	129
Nålelejer	139
Aksialnålelejer	153
Cylindriske aksialrullelejer	155
Løbe-, støtte- og kamruller	159
Glidelejer	167
Højpræcisionslejer	175
Indeks	181

13	Förord
19	Spårkullager
33	Sfäriska kullager
37	Vinkelkontaktkullager
45	Koniska rullager
49	Koniska rullager med tumdimensioner
53	Cylindriska rullager
63	Sfäriska rullager
69	CARB®
73	Axialkullager
79	Sfäriska axialrullager
81	Y-lager
107	SKF ConCentra
109	Lagerhus
129	Tillbehör
139	Nålrullager
153	Axialnålrullager
155	Cylindriska axialrullager
159	Löp-, stöd- och kamrullar
167	Glidlager
175	Precisionslager
181	Index

Forord	13
Sporkulelager	19
Sfæriske kulelager	33
Vinkelkontaktkulelager	37
Koniske rullelager	45
Koniske rullelager i tommemål	49
Sylindriske rullelager	53
Sfæriske rullelager	63
CARB®	69
Aksialkulelager	73
Sfæriske aksialrullelager	79
Y-lager	81
SKF ConCentra	107
Lagerhus	109
Tilbehør	129
Nålerullelager	139
Aksialnålerullelager	153
Sylindriske aksialrullelager	155
Løpe-, støtte- og kamruller	159
Glidelager	167
Høypresisjonslager	175
Indeks	181

13	Εισαγωγή
19	Ένσφαιρα ρουλεμάν βαθέως αύλακος
33	Δίσφαιρα αυτορρυθμιστα ρουλεμάν
37	Ένσφαιρα ρουλεμάν γωνιακής επαφής
45	Κωνικά ρουλεμάν
49	Κωνικά ρουλεμάν σε ίντσες
53	Κυλινδρικά ρουλεμάν
63	Βαρελοειδή ρουλεμάν
69	CARB®
73	Ένσφαιρα ωστικά ρουλεμάν
79	Ωστικά βαρελοειδή ρουλεμάν
81	Φλατζωτά και τύπου Ω έδρανα
107	Έδρανα Concentra
109	Έδρανα
129	Εξαρτήματα
139	Βελονοειδή ρουλεμάν
153	Ωστικά βελονοειδή ρουλεμάν
155	Ωστικά κυλινδρικά ρουλεμάν
159	Ράουλα
167	Έδρανα αρθρώσεων και ακρόμπαρα
175	Ρουλεμάν υψηλής ακριβείας
181	Ευρετήριο

Foreword

This price list is valid on products delivered after January 31, 2011 until further notice and replaces all former corresponding SKF price lists.

The assortment included covers the most frequently demanded SKF industrial bearings and accessories but represents only a minor part of the total SKF product range. For items not listed or priced as *** please contact your SKF representative.

The text is, where possible, shown in eleven languages. However, some of the table heads contain abbreviations in English only.

The conditions ruling the trade with SKF such as technical aspects, confidentiality, warranties, limitations of liability, pricing conditions, packaging, delivery time, payment terms, returns and claims and any other term and condition of sales are set out in the terms and conditions established by SKF in each market or as otherwise specifically agreed in writing with the SKF representative.

Every care has been taken to ensure the accuracy of the information contained in the price list but SKF will assume no liability for any errors or omissions.

Note. All items marked *** are priced on request.

Vorwort

Diese Preisliste – gültig für Lieferungen ab dem 31. Januar 2011 – ersetzt alle bisherigen Preislisten mit dem gleichen Inhalt.

Die darin enthaltene Sortimentsauswahl stellt die vom Markt am stärksten nachgefragten Lagertypen und Zubehör dar, repräsentiert jedoch nur einen kleinen Teil des gesamten SKF Produktsortimentes. Typen, die nicht in der Liste aufgeführt sind oder mit *** gekennzeichnet sind, können Sie bei Ihrem SKF Vertriebspartner erfragen.

Der Text wurde, soweit möglich, in elf Sprachen übersetzt. Leider können aus Platzgründen einige Abkürzungen in den Kopfzeilen nur in der englischen Sprache gezeigt werden.

Die Bedingungen, auf denen die Geschäftsbeziehung mit SKF beruht, wie technische Inhalte, Vertraulichkeit, Preisvereinbarungen, Verpackungen, Lieferzeiten, Zahlvereinbarungen, Gewährleistung und alle weiteren Lieferbedingungen zu denen die Geschäfte mit SKF abgewickelt werden, basieren auf den vom zuständigen lokalen SKF Vertriebspartner etablierten allgemeinen Lieferbedingungen, wie sie in den jeweiligen Verträgen mit dem Kunden vereinbart und in den Rechnungen niedergelegt sind.

Die genannten Preise stellen keine Preisempfehlung für den Wiederverkäufer dar. SKF behält sich vor, einzelne in dieser Preisliste enthaltene Produkte auch ohne Vorankündigung nach Abwägung wirtschaftlicher/technischer Gesichtspunkte zu streichen.

Die Informationen dieser Preisliste sind mit größter Sorgfalt zusammengestellt worden. Wir können jedoch für fehlerhafte und unvollständige Angaben keine Haftung übernehmen.

Anmerkung. Alle Positionen, die mit *** gekennzeichnet sind, werden auf Anfrage angeboten.

Avant-propos

Le présent tarif est applicable à toutes les livraisons à compter du 31 janvier 2011 et jusqu'à nouvel ordre. Il remplace le précédent tarif en vigueur.

Les références mentionnées correspondent aux roulements et accessoires industriels SKF les plus fréquemment demandés, mais ne représentent qu'une petite partie de l'ensemble de la gamme SKF. Si l'article qui vous intéresse ne figure pas dans la liste ou est tarifé avec ***, veuillez contacter votre représentant SKF.

Chaque fois que possible, le texte apparaît en onze langues. Certains en-têtes de tableaux incluent cependant des abréviations fournies uniquement en anglais.

Tout ce qui se rapporte aux conditions de vente, comme les aspects techniques, la confidentialité, les conditions tarifaires, le conditionnement, les délais de livraison, les modalités de paiement, les réclamations, ainsi que toutes autres conditions, reste couvert par les conditions générales de vente telles que spécifiées par SKF sur chaque marché ou spécialement convenues par écrit avec le représentant SKF.

Le plus grand soin a été apporté à l'exactitude des informations contenues dans ce barème ; SKF décline cependant toute responsabilité en cas d'erreur ou d'omission.

Note. Tous les articles avec le symbole *** sont tarifés sur demande.

Avvertenza

Il presente listino prezzi, valido per consegne a partire dal 31 Gennaio 2011, annulla e sostituisce tutti i precedenti listini SKF dello stesso tipo.

Esso elenca i cuscinetti e gli accessori più frequentemente richiesti dall'industria, ma rappresenta solo in piccola parte il vasto assortimento dei prodotti SKF. Per le voci non riportate o per gli articoli contrassegnati con *** siete pregati di rivolgervi al Vostro Concessionario Autorizzato o direttamente alla SKF.

Il testo, ove possibile, è stato redatto in undici lingue. Tuttavia, nelle intestazioni di alcune tabelle, si sono dovute utilizzare abbreviazioni solo in inglese.

Per quanto riguarda gli aspetti tecnici, la riservatezza dei dati, le garanzie, le limitazioni di responsabilità, i prezzi, le confezioni, i tempi di consegna, i termini di pagamento, i resi, i reclami e ogni altro elemento connesso con la vendita, si rimanda alle condizioni specificate dalla SKF per ciascun mercato o alle clausole contrattuali concordate con i rappresentanti SKF locali.

Alla stesura del presente listino è stata dedicata la massima attenzione al fine di assicurare l'accuratezza delle informazioni in esso contenute, tuttavia non si accettano responsabilità per eventuali errori od omissioni.

Nota: il prezzo di tutti gli articoli contrassegnati con *** è disponibile su richiesta.

Prólogo

Esta lista de precios es válida para entregas realizadas a partir del 31 de enero de 2011, hasta nuevo aviso, y sustituye todas las anteriores listas de precios SKF correspondientes. La gama de productos abarca los rodamientos y accesorios industriales SKF más demandados, pero representa sólo una pequeña parte de la gama total de productos SKF. Para todos aquellos artículos no incluidos en esta lista o marcados con ***, rogamos contacten con su representante local SKF.

El texto se muestra, dentro de lo posible, en doce idiomas. Sin embargo, algunos encabezados de las tablas sólo contienen abreviaturas en inglés.

Las condiciones que rigen su relación con SKF tales como los aspectos técnicos, la confidencialidad, las condiciones de garantía, las limitaciones de responsabilidad, los precios, los embalajes, los plazos de entrega, las condiciones de pago, las devoluciones y reclamaciones, así como cualquier otra condición de venta se especifican en nuestros términos y condiciones establecidos por SKF en cada mercado, o según el acuerdo específico por escrito con su representante local SKF.

Se ha tenido el máximo cuidado para garantizar la exactitud de la información contenida en esta lista de precios, pero SKF no aceptará ninguna responsabilidad por cualquier error u omisión.

Nota: Consultar precio para los productos marcados con ***

Voorwoord

Deze prijslijst is geldig voor alle leveringen vanaf 31 januari 2011. Hiermee vervallen alle voorgaande prijslijsten van SKF met dezelfde inhoud.

Het in de prijslijst opgenomen assortiment vertegenwoordigt de meest populaire SKF lagers en accessoires, maar is slechts een klein gedeelte van het totale SKF assortiment. De prijzen van artikelen die niet in deze prijslijst zijn vermeld of zijn gemarkeerd met ***, worden u op aanvraag verstrekt.

De tekst is, waar mogelijk, vermeld in de 11 talen. Echter, in een aantal tabelkopjes hebben we alleen afkortingen in de Engelse taal gebruikt.

Inzake technische aspecten, betrouwbaarheid, prijscondities, verpakking, levertijd, betalingscondities, retourzendingen en claims zijn de Algemene Verkoopvoorwaarden van SKF Nederland of SKF België van kracht.

Hoewel de inhoud van deze prijslijst met de uiterste zorgvuldigheid op haar juistheid is gecontroleerd, kan door SKF voor eventuele onjuiste of onvolledige gegevens geen aansprakelijkheid worden aanvaard.

NB: De prijzen van artikelen gemarkeerd met *** worden op aanvraag verstrekt.

Johdanto

Tämä hintalista astuu voimaan 31 tammikuuta 2011 ja korvaa kaikki aiemmat samansisältöiset SKF:n hinnastot. Uudet hinnat astuvat voimaan siten, että koskevat kaikkia toimituksia 31 tammikuuta 2011 lähtien.

Hinnaston valikoima on yleisesti käytössä olevia SKF:n teollisuuslaakereita ja laakerointivarvikkeita ja edustaa vain osaa koko tuotevalikoimasta. Laajemmasta tuotevalikoimasta tai tuotteista, joissa merkintä *** saa tietoja SKF:n edustajilta tai SKF:n valtuutetuilta jälleenmyyjiltä.

Tekstityksessä on mahdollisuuksien mukaan käytetty yhtätoista eri kieltä. Taulukoissa ja eräissä muissa paikoissa on tilanpuutteen takia käytetty pelkästään englannin kieltä.

Myyntiehdot, kuten tekniset yksityiskohdat, luottamuksellisuus, alennukset, pakkaukset, toimitusajat, maksuehdot, palautukset, reklamaatiot ja muut mahdolliset erikseen sovittavat yksityiskohdat sovitetaan paikallisten SKF:n edustajien kanssa.

Hinnaston sisältö on tarkastettu huolellisesti. SKF ei kuitenkaan ota vastuuta mahdollisista painovirheistä tai puutteista.

Huom. Kaikkien *** merkittyjen tuotteiden hinnat annetaan pyydettyinä.

Introdução

Esta Lista de Preços é válida para fornecimentos a partir de 31 de Janeiro de 2011 e, substitui as correspondentes Listas de Preços anteriormente publicadas pela SKF.

A gama incluída engloba os rolamentos e acessórios industriais da SKF mais frequentemente procurados, mas representa uma pequena parte da gama de produtos SKF. Para os itens não incluídos, por favor contacte o Distribuidor Autorizado SKF mais próximo.

O texto está, dentro do possível, nos onze idiomas. No entanto, nos títulos de algumas colunas tivemos de utilizar abreviaturas apenas em Inglês.

As condições que regem os negócios com a SKF, tais como os aspectos técnicos, confidencialidade, condições de preços, embalagem, prazos de entrega, condições de pagamento, devoluções e reclamações, e quaisquer termos e condições de venda, são determinados pelas regras standard, tal como estão especificados nos contratos e facturas, estabelecidos por e com o representante legal da SKF em cada mercado.

Foram tomadas todas as precauções para assegurar a exactidão da informação contida na Lista de Preços, mas não aceitaremos quaisquer responsabilidade por erros ou omissões.

Nota. *** preço sob consulta.

Forord

Denne prisliste gælder fra og med 31. januar 2011 og erstatter alle tidligere SKF prislister.

Prislisten omfatter de mest gængse SKF produkter inden for lejer og tilbehør. Den udgør en mindre del af det komplette SKF sortiment - kontakt derfor SKF eller nærmeste autoriserede SKF forhandler for at få oplysninger om de produkter, som ikke er nævnt i listen.

Teksten i prislisten er så vidt muligt skrevet på 11 forskellige sprog. Visse kolonneoverskrifter er dog forkortet og er kun på engelsk.

Betingelserne for handel med SKF - vedrørende tekniske områder, fortrolighed, prisforhold, emballering, leveringstid, betalingsbetingelser, returnering, klager samt alle øvrige salgsforhold - er gældende i henhold til de kontrakter og leveringsbetingelser, som er indgået med SKF Danmark A/S eller en autoriseret SKF forhandler.

Alle oplysninger i denne prisliste er omhyggeligt kontrolleret, men SKF påtager sig intet ansvar for eventuelle fejl eller udeladelser.

Förord

Denna prislista gäller för produkter levererade fr.o.m. den 31 januari 2011 och ersätter alla SKFs tidigare prislistor med samma innehåll och inriktning

Det inkluderade sortimentet täcker de mest efterfrågade av SKFs lager och tillbehör, men representerar endast en mindre del av SKFs totala produktsortiment. För produkter som ej återfinns i listan eller med priset ***, ber vi er kontakta närmaste SKF representant.

Texten visas, där så är möjligt, på elva språk. Vi har dock, i vissa tabellhuvuden, använt oss av förkortningar på enbart engelska.

När det gäller övriga affärsöverenskommelser med SKF som t ex tekniska och konfidentiella aspekter, pris- och leveransvillkor, emballage, leveranstider, betalningsvillkor, retur och andra överenskommelser, regleras dessa av våra standardvillkor specificerad på fakturor och i överenskomna avtal med vår lokala SKF representant.

Största omsorg har lagts ner på att säkerställa riktigheten av informationen i denna prislista, men SKF påtar sig inget ansvar för eventuella felaktiga eller utelämnade uppgifter.

SKF förbehåller sig rätten att när som helst, på eget bevåg och utan förvarning ändra delar av eller hela prislistan.

OBS:För alla produkter med priset *** lämnas pris vid förfrågan.

Forord

Denne prislisten gjelder for produkter levert f.o.m. 31 januar 2011 og erstatter alle SKF's tidligere prislister med tilsvarende innhold.

Sortimentet som er inkludert i prislisten dekker de mest etterspurte SKF lager og tilhører, men utgjør kun en liten del av SKF's totale produktsortiment. Opplysninger vedrørende produkter som ikke er oppført i listen eller er merket med *** kan innhentes hos nærmeste SKF forhandler.

Der dette er mulig vises teksten på elleve ulike språk. I noen av tabelloverskriftene har vi imidlertid måttet benytte kun engelske forkortelser.

Når det gjelder betingelser for handel med SKF vedrørende tekniske områder, fortlørlighet, prisforhold, emballasje, leveringstid, betalingsbetingelser, returer, reklamasjoner og øvrige salgsforhold, så reguleres disse av våre standard vilkår som er spesifisert på fakturaer og er i henhold til avtale med våre lokale SKF-forhandlere.

All informasjon i denne prislisten er omhyggelig kontrollert, men SKF kan ikke påta seg ansvar for eventuelle feil eller manglende opplysninger.

Pris på alle produkter merket med *** blir oppgitt på forespørsel.

Εισαγωγή

Αυτός ο τιμοκατάλογος ισχύει για προϊόντα που θα παραδοθούν μετά την 31η Ιανουαρίου 2011 και αντικαθιστά όλους τους προηγούμενους αντίστοιχους τιμοκαταλόγους της SKF.

Τα προϊόντα που περιέχονται καλύπτουν τα συνηθέστερα βιομηχανικά ρουλεμάν και εξαρτήματα της SKF. Όμως αυτά αποτελούν ένα μικρό τμήμα όλης της ποικιλίας των προϊόντων της SKF. Για προϊόντα που δεν βρίσκονται στον κατάλογο, μπορείτε να απευθύνεστε στον πλησιέστερο στην περιοχή σας εξουσιοδοτημένο συνεργάτη της SKF.

Το κείμενο είναι μεταφρασμένο σε ακόμα 11 γλώσσες. Παρόλα αυτά σε κάποιους πίνακες δίνονται συντομεύσεις μόνο στα αγγλικά.

Οι όροι συνεργασίας με την SKF σχετικά με τεχνικά ζητήματα, εχεμύθεια, εκπώσεις, συσκευασία προϊόντων, αποπληρωμή, επιστροφές και διεκδικήσεις καθώς και όλοι οι όροι και συνθήκες πώλησης των προϊόντων SKF αναγράφονται στις συμβάσεις και στα τιμολόγια πώλησης όπως καθορίζονται από την SKF σε κάθε αγορά.

Ιδιαίτερη προσοχή έχει δοθεί στην ακρίβεια των πληροφοριών που περιέχονται στον κατάλογο. Παρόλα αυτά, η SKF δεν φέρει καμία ευθύνη για τυχόν λάθη ή παραλείψεις

Ένσφαιρα ρουλεμάν βαθέως αύλακος

Urakuulalaakerit

Rolamentos rígidos de esferas

Sporkuglelejer

Spårkullager

Sporkulelager

Deep groove ball bearings
 Rillenkugellager
 Roulements rigides à billes
 Cuscinetti radiali a sfera
 Rodamientos rígidos de bolas
 Groefkogellagers

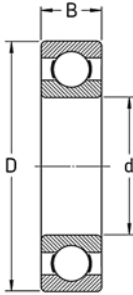

60	21
62	23
63	25
64	27
160	28
161	28
618	28
619	29
630	30
E2	30

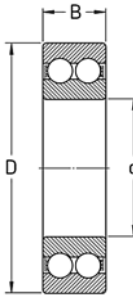

42	31
43	31

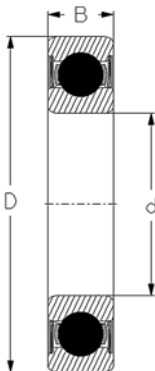

HYBRID	31
--------	-------	----

Deep groove ball bearings
 Rillenkugellager
 Roulements rigides à billes
 Cuscinetti radiali a sfera
 Rodamientos rígidos de bolas
 Groefkogellagers

Ένσφαιρα ρουλεμάν βαθέως αύλακος
 Urakuulalaakerit
 Rolamentos rígidos de esferas
 Sporkuglelejer
 Spårkullager
 Sporkulelager

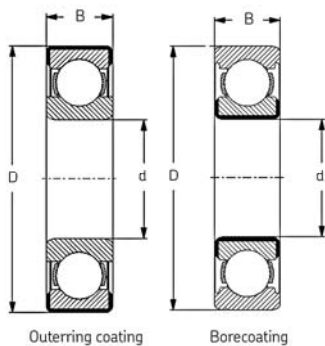

INSOCOAT 32

3612.. R 32
 W 60.. 32
 W 62.. 32
 W 63.. 32

Ένσφαιρα ρουλεμάν βαθύς αύλακος

Urakuilalaakerit

Rolamentos rígidos de esferas

Spørkuglelejer

Spårkullager

Spørkulelager

Deep groove ball bearings

Rillenkugellager

Roulements rigides à billes

Cuscinetti radiali a sfera

Rodamientos rígidos de bolas

Groefkogellagers

	€	d	D	B	min		€	d	D	B	min
604-Z	***	4	12	4	10	* 6002-RSH	***	15	32	9	10
* 607	***	7	19	6	10	* 6002-Z	***	15	32	9	10
* 607-2RSH	8,70	7	19	6	10	* 6003	9,00	17	35	10	10
* 607-2RSH/C3	8,70	7	19	6	10	* 6003-2RSH	11,71	17	35	10	10
* 607-Z	7,72	7	19	6	10	* 6003-2RSH/C3	11,71	17	35	10	10
* 607-2Z/C3	7,72	7	19	6	10	* 6003-Z	10,39	17	35	10	10
* 607-Z	***	7	19	6	10	* 6003-2Z/C3	10,80	17	35	10	10
* 608	6,64	8	22	7	10	* 6003-RSH	***	17	35	10	10
* 608-2RSH	8,65	8	22	7	10	* 6003-Z	***	17	35	10	10
* 608-2RSH/C3	8,65	8	22	7	10	* 6004	10,00	20	42	12	10
* 608-2RSL	***	8	22	7	10	* 6004-2RSH	13,00	20	42	12	10
* 608-2Z	7,66	8	22	7	10	* 6004-2RSH/C3	13,00	20	42	12	10
* 608-2Z/C3	7,66	8	22	7	10	* 6004-2RSL	13,92	20	42	12	10
* 608-RSH	***	8	22	7	10	* 6004-2Z	11,50	20	42	12	10
* 608-Z	***	8	22	7	10	* 6004-2Z/C3	11,50	20	42	12	10
W 608-2Z	***	8	22	7	10	* 6004-RSH	***	20	42	12	10
* 609	***	9	24	7	10	* 6004-Z	12,29	20	42	12	10
* 609-2RSH	9,01	9	24	7	10	* 6005	11,47	25	47	12	10
* 609-2RSH/C3	9,01	9	24	7	10	* 6005-2RSH	14,94	25	47	12	10
* 609-Z	7,99	9	24	7	10	* 6005-2RSH/C3	14,94	25	47	12	10
* 609-2Z/C3	7,99	9	24	7	10	* 6005-2Z	13,19	25	47	12	10
* 609-Z	***	9	24	7	10	* 6005-2Z/C3	13,72	25	47	12	10
* 6000	7,26	10	26	8	10	* 6005-RSH	***	25	47	12	10
* 6000-2RSH	9,46	10	26	8	10	* 6005-Z	***	25	47	12	10
* 6000-2RSH/C3	9,46	10	26	8	10	* 6005-2ZNR	***	25	52,7	12	10
* 6000-2RSL	***	10	26	8	10	* 6006	14,09	30	55	13	5
* 6000-2Z	8,34	10	26	8	10	* 6006-2RS1	18,30	30	55	13	5
* 6000-2Z/C3	8,34	10	26	8	10	* 6006-2RS1/C3	18,30	30	55	13	5
* 6000-RSH	***	10	26	8	10	* 6006-2RZ	***	30	55	13	5
* 6000-Z	***	10	26	8	10	* 6006-2Z	16,21	30	55	13	5
W 6000-2Z	***	10	26	8	10	* 6006-2Z/C3	16,78	30	55	13	5
* 6001	7,79	12	28	8	10	* 6006-RS1	***	30	55	13	5
* 6001-2RSH	10,17	12	28	8	10	* 6006-Z	***	30	55	13	5
* 6001-2RSH/C3	10,17	12	28	8	10	* 6007	17,46	35	62	14	5
* 6001-2RSL	10,90	12	28	8	10	* 6007/C3	***	35	62	14	5
* 6001-2Z	8,99	12	28	8	10	* 6007-2RS1	22,69	35	62	14	5
* 6001-2Z/C3	8,99	12	28	8	10	* 6007-2RS1/C3	22,69	35	62	14	5
* 6001-RSH	***	12	28	8	10	* 6007-2Z	20,10	35	62	14	5
* 6001-Z	***	12	28	8	10	* 6007-2Z/C3	20,80	35	62	14	5
* 6002	8,54	15	32	9	10	* 6007-RS1	***	35	62	14	5
* 6002-2RSH	11,15	15	32	9	10	* 6007-Z	***	35	62	14	5
* 6002-2RSH/C3	11,15	15	32	9	10	* 6008	21,93	40	68	15	5
* 6002-2RSL	***	15	32	9	10	* 6008-2RS1	28,52	40	68	15	5
* 6002-2Z	9,85	15	32	9	10	* 6008-2RS1/C3	28,52	40	68	15	5
* 6002-2Z/C3	10,24	15	32	9	10	* 6008-2Z	25,24	40	68	15	5

* = Explorer



Deep groove ball bearings
Rillenkugellager
Roulements rigides à billes
Cuscinetti radiali a sfera
Rodamientos rígidos de bolas
Groefkogellagers

Ένσφαιρα ρουλεμάν βαθέως αύλακος
Urakuulalaakerit
Rolamentos rígidos de esferas
Sporkuglelejer
Spårkullager
Sporkulelager

	€	d	D	B	min		€	d	D	B	min
* 6008-2Z/C3	26,11	40	68	15	5	* 6015-2Z	103,33	75	115	20	
* 6008-RS1	***	40	68	15	5	* 6015-Z	***	75	115	20	
* 6008-Z	***	40	68	15	5	* 6016	109,32	80	125	22	
* 6009	28,50	45	75	16	5	* 6016/C3	***	80	125	22	
* 6009-2RS1	37,05	45	75	16	5	* 6016-2RS1	137,21	80	125	22	
* 6009-2RS1/C3	37,05	45	75	16	5	* 6016-2Z	125,90	80	125	22	
* 6009-2Z	32,76	45	75	16	5	* 6016-Z	***	80	125	22	
* 6009-2Z/C3	33,89	45	75	16	5	* 6017	122,59	85	130	22	
* 6009-RS1	***	45	75	16	5	* 6017-2RS1	159,35	85	130	22	
* 6009-Z	***	45	75	16	5	* 6017-2Z	140,75	85	130	22	
* 6010	33,02	50	80	16	5	* 6017-Z	***	85	130	22	
* 6010-2RS1	42,94	50	80	16	5	* 6018	145,64	90	140	24	
* 6010-2RS1/C3	42,94	50	80	16	5	* 6018-2RS1	189,38	90	140	24	
* 6010-2Z	37,97	50	80	16	5	* 6018-2Z	167,50	90	140	24	
* 6010-2Z/C3	39,29	50	80	16	5	* 6018-Z	***	90	140	24	
* 6010-RS1	***	50	80	16	5	* 6019	***	95	145	24	
* 6010-Z	***	50	80	16	5	* 6019-2RS1	219,74	95	145	24	
* 6011	42,18	55	90	18	5	* 6019-2Z	***	95	145	24	
* 6011-2RS1	54,87	55	90	18	5	* 6020	185,90	100	150	24	
* 6011-2RS1/C3	56,76	55	90	18	5	* 6020-2RS1	233,71	100	150	24	
* 6011-2Z	48,51	55	90	18	5	* 6020-2Z	213,79	100	150	24	
* 6011-2Z/C3	50,19	55	90	18	5	* 6020-Z	***	100	150	24	
* 6011-RS1	***	55	90	18	5	* 6021	229,65	105	160	26	
* 6011-Z	***	55	90	18	5	* 6021-2RS1	***	105	160	26	
* 6012	48,37	60	95	18	5	* 6021-2Z	***	105	160	26	
* 6012-2RS1	62,81	60	95	18	5	* 6022	275,50	110	170	28	
* 6012-2RS1/C3	62,81	60	95	18	5	* 6022-2RS1	368,96	110	170	28	
* 6012-2Z	55,67	60	95	18	5	* 6022-2Z	***	110	170	28	
* 6012-2Z/C3	57,61	60	95	18	5	* 6024	314,04	120	180	28	
* 6012-RS1	***	60	95	18	5	* 6024-2RS1	408,47	120	180	28	
* 6012-Z	***	60	95	18	5	* 6024-2Z	384,60	120	180	28	
* 6013	61,78	65	100	18	5	* 6024-Z	***	120	180	28	
* 6013-2RS1	77,64	65	100	18	5	* 6026	414,70	130	200	33	
* 6013-2RS1/C3	80,32	65	100	18	5	* 6026-2RS1	***	130	200	33	
* 6013-2Z	71,09	65	100	18	5	6028	491,38	140	210	33	
* 6013-2Z/C3	***	65	100	18	5	6028-2RS1	713,85	140	210	33	
* 6013-RS1	***	65	100	18	5	6030	596,80	150	225	35	
* 6013-Z	***	65	100	18	5	6030-2RS1	860,20	150	225	35	
* 6014	78,43	70	110	20		6032 M	1073,73	160	240	38	
* 6014-2RS1	98,60	70	110	20		6032-2RS1	1469,68	160	240	38	
* 6014-2RS1/C3	101,95	70	110	20		6034 M	1275,06	170	260	42	
* 6014-2Z	90,27	70	110	20		6034 M/C3	***	170	260	42	
* 6014-Z	***	70	110	20		6036 M	***	180	280	46	
* 6015	89,86	75	115	20		6038 M	***	190	290	46	
* 6015-2RS1	113,03	75	115	20		6040 M	***	200	310	51	

* = Explorer

Ένσφαιρα ρουλεμάν βαθύς αύλακος

Urakuulalaakerit

Rolamentos rígidos de esferas

Spørkuglelejer

Spårkullager

Sporkulelager

Deep groove ball bearings

Rillenkugellager

Roulements rigides à billes

Cuscinetti radiali a sfera

Rodamientos rígidos de bolas

Groefkogellagers

	€	d	D	B	min		€	d	D	B	min
6044 M	***	220	340	56		* 6200-RSH	***	10	30	9	10
6048 M	***	240	360	56		* 6200-Z	***	10	30	9	10
						62200-2RS1	22,21	10	30	14	10
						* 6201	7,61	12	32	10	10
						* 6201-2RSH	9,88	12	32	10	10
628/4-ZZ	***	4	9	3,5	10	* 6201-2RSH/C3	9,88	12	32	10	10
623	***	3	10	4	10	* 6201-2RSL	***	12	32	10	10
623-2RS1	***	3	10	4	10	* 6201-ZZ	8,76	12	32	10	10
623-ZZ	10,07	3	10	4	10	* 6201-ZZ/C3	8,76	12	32	10	10
628/5-ZZ	18,02	5	11	4	10	* 6201-RSH	***	12	32	10	10
624	***	4	13	5	10	* 6201-Z	***	12	32	10	10
624-2RS1	***	4	13	5	10	62201-2RS1	22,48	12	32	14	10
624-ZZ	8,72	4	13	5	10	* 6200-2ZNR	***	10	34,7	9	10
628/6-ZZ	18,02	6	13	5	10	* 6202	8,18	15	35	11	10
628/7-ZZ	18,02	7	14	5	10	* 6202 TN9/C3	9,55	15	35	11	10
* 625	***	5	16	5	10	* 6202/C3	8,52	15	35	11	10
* 625-2RS1	8,77	5	16	5	10	* 6202-2RSH	10,65	15	35	11	10
* 625-ZZ	7,79	5	16	5	10	* 6202-2RSH/C3	10,65	15	35	11	10
* 625-ZZ/C3	8,07	5	16	5	10	* 6202-2RSL	***	15	35	11	10
* 625-Z	***	5	16	5	10	* 6202-ZZ	9,42	15	35	11	10
* 628/8-2RS1	17,49	8	16	5	10	* 6202-ZZ/C3	9,42	15	35	11	10
* 628/8-ZZ	17,62	8	16	5	10	* 6202-RSH	***	15	35	11	10
628/9-ZZ	***	9	17	5	10	* 6202-Z	***	15	35	11	10
* 626	***	6	19	6	10	* 6202-ZTN9	10,97	15	35	11	10
* 626-2RSH	8,63	6	19	6	10	* 6202-ZTN9/LT	13,27	15	35	11	10
* 626-2RSH/C3	8,98	6	19	6	10	62202-2RS1	25,01	15	35	14	10
* 626-ZZ	7,61	6	19	6	10	62300-2RS1	***	10	35	17	10
* 626-ZZ/C3	7,90	6	19	6	10	* 6201-2ZNR	***	12	36,7	10	10
* 626-RSH	***	6	19	6	10	62301-2RS1	27,94	12	37	17	10
* 626-Z	***	6	19	6	10	* 6202-2ZNR	15,30	15	39,7	11	10
* 627	***	7	22	7	10	* 6203	9,23	17	40	12	10
* 627-2RSH	8,50	7	22	7	10	* 6203/C3	9,59	17	40	12	10
* 627-ZZ	7,53	7	22	7	10	* 6203-2RSH	11,98	17	40	12	10
* 627-Z	***	7	22	7	10	* 6203-2RSH/C3	11,98	17	40	12	10
* 629	***	9	26	8	10	* 6203-ZZ	10,56	17	40	12	10
* 629-2RSH	9,16	9	26	8	10	* 6203-ZZ/C3	10,56	17	40	12	10
* 629-2RSH/C3	9,52	9	26	8	10	* 6203-RSH	***	17	40	12	10
* 629-ZZ	8,10	9	26	8	10	* 6203-Z	***	17	40	12	10
* 629-ZZ/C3	8,42	9	26	8	10	62203-2RS1	27,32	17	40	16	10
* 629-Z	***	9	26	8	10	62302-2RS1	29,07	15	42	17	10
* 6200	7,27	10	30	9	10	* 6204	10,82	20	47	14	10
* 6200-2RSH	9,47	10	30	9	10	* 6204 TN9/C4	13,90	20	47	14	10
* 6200-2RSH/C3	9,47	10	30	9	10	* 6204/C3	10,82	20	47	14	10
* 6200-ZZ	8,38	10	30	9	10	* 6204-2RSH	14,08	20	47	14	10
* 6200-ZZ/C3	8,38	10	30	9	10	* 6204-2RSH/C3	14,08	20	47	14	10

* = Explorer

SKF

Deep groove ball bearings
Rillenkugellager
Roulements rigides à billes
Cuscinetti radiali a sfera
Rodamientos rígidos de bolas
Groefkogellagers

Ένσφαιρα ρουλεμάν βαθέως αύλακος
Urakuulalaakerit
Rolamentos rígidos de esferas
Sporrkuglelejer
Spårkullager
Sporkulelager

	€	d	D	B	min		€	d	D	B	min
* 6204-2RSL	15,08	20	47	14	10	* 6208	29,45	40	80	18	5
* 6204-2Z	12,35	20	47	14	10	* 6208/C3	30,47	40	80	18	5
* 6204-2Z/C3	12,35	20	47	14	10	* 6208-2RS1	38,31	40	80	18	5
* 6204-RSH	***	20	47	14	10	* 6208-2RS1/C3	38,31	40	80	18	5
* 6204-Z	***	20	47	14	10	6208-2RS1K	44,41	40	80	18	5
62204-2RS1	29,93	20	47	18	10	* 6208-2Z	33,89	40	80	18	5
62303-2RS1	32,68	17	47	19	10	* 6208-2Z/C3	33,89	40	80	18	5
* 62/22-2RS1	22,51	22	50	14	10	* 6208-RS1	***	40	80	18	5
* 6205	12,59	25	52	15	5	* 6208-Z	***	40	80	18	5
* 6205/C3	13,09	25	52	15	5	62208-2RS1	63,83	40	80	23	5
* 6205-2RSH	16,44	25	52	15	5	* 6209	36,04	45	85	19	5
* 6205-2RSH/C3	16,44	25	52	15	5	* 6209/C3	37,28	45	85	19	5
* 6205-2RSH/C4	19,37	25	52	15	5	* 6209-2RS1	46,77	45	85	19	5
* 6205-2RSL	***	25	52	15	5	* 6209-2RS1/C3	46,77	45	85	19	5
* 6205-2Z	14,52	25	52	15	5	6209-2RS1K	***	45	85	19	5
* 6205-2Z/C3	14,52	25	52	15	5	* 6209-2Z	41,41	45	85	19	5
* 6205-RSH	***	25	52	15	5	* 6209-2Z/C3	41,41	45	85	19	5
* 6205-Z	***	25	52	15	5	* 6209-RS1	***	45	85	19	5
62205-2RS1	32,96	25	52	18	10	* 6209-Z	***	45	85	19	5
62304-2RS1	38,19	20	52	21	10	62209-2RS1	85,27	45	85	23	5
* 6204-2ZNR	19,39	20	52,7	14	10	* 6210	42,63	50	90	20	5
* 6205-2ZNR	***	25	57,9	15	5	* 6210/C3	42,63	50	90	20	5
62/28-2RS1	27,37	28	58	16	5	* 6210-2RS1	55,39	50	90	20	5
* 6206	16,89	30	62	16	5	* 6210-2RS1/C3	55,39	50	90	20	5
* 6206/C3	17,47	30	62	16	5	* 6210-2Z	48,99	50	90	20	5
* 6206-2RS1	21,93	30	62	16	5	* 6210-2Z/C3	48,99	50	90	20	5
* 6206-2RS1/C3	21,93	30	62	16	5	* 6210-RS1	***	50	90	20	5
* 6206-2Z	19,44	30	62	16	5	* 6210-Z	***	50	90	20	5
* 6206-2Z/C3	19,44	30	62	16	5	62210-2RS1	100,74	50	90	23	5
* 6206-RS1	***	30	62	16	5	62308-2RS1	110,41	40	90	33	5
* 6206-Z	***	30	62	16	5	* 6210-2ZNR	***	50	96,5	20	5
62206-2RS1	42,52	30	62	20	5	* 6211	50,34	55	100	21	5
62305-2RS1	49,83	25	62	24	5	* 6211/C3	52,09	55	100	21	5
* 6206-2RS1NR	***	30	67,7	16	5	* 6211-2RS1	65,42	55	100	21	5
* 6207	22,25	35	72	17	5	* 6211-2RS1/C3	65,42	55	100	21	5
* 6207/C3	22,25	35	72	17	5	* 6211-2Z	57,94	55	100	21	5
* 6207-2RS1	28,92	35	72	17	5	* 6211-2Z/C3	57,94	55	100	21	5
* 6207-2RS1/C3	28,92	35	72	17	5	* 6211-RS1	***	55	100	21	5
6207-2RS1K	53,19	35	72	17	5	* 6211-Z	***	55	100	21	5
* 6207-2Z	25,59	35	72	17	5	62211-2RS1	125,68	55	100	25	5
* 6207-2Z/C3	25,59	35	72	17	5	* 6212	62,61	60	110	22	
* 6207-RS1	***	35	72	17	5	* 6212/C3	62,61	60	110	22	
* 6207-Z	***	35	72	17	5	* 6212-2RS1	81,39	60	110	22	
62207-2RS1	55,26	35	72	23	5	* 6212-2RS1/C3	81,39	60	110	22	
62306-2RS1	68,63	30	72	27	5	* 6212-2Z	71,94	60	110	22	

* = Explorer

Ένσφαιρα ρουλεμάν βαθύς αúλακος

Urakuulalaakerit

Rolamentos rígidos de esferas

Spørkuglelejer

Spårkullager

Spørkulelager

Deep groove ball bearings

Rillenkugellager

Roulements rigides à billes

Cuscinetti radiali a sfera

Rodamientos rígidos de bolas

Groefkogellagers

	€	d	D	B	min		€	d	D	B	min
* 6212-2Z/C3	71,94	60	110	22		* 6218	218,85	90	160	30	
* 6212-RS1	***	60	110	22		* 6218/C3	218,85	90	160	30	
* 6212-Z	***	60	110	22		* 6218-2RS1	284,17	90	160	30	
62212-2RS1	161,52	60	110	28		* 6218-2Z	251,94	90	160	30	
62310-2RS1	178,87	50	110	40		* 6218-2Z/C3	***	90	160	30	
* 6213	91,86	65	120	23		* 6218-Z	***	90	160	30	
* 6213/C3	91,86	65	120	23		* 6219	***	95	170	32	
* 6213-2RS1	115,75	65	120	23		* 6219/C3	264,18	95	170	32	
* 6213-2RS1/C3	119,68	65	120	23		* 6219-2Z	***	95	170	32	
* 6213-2Z	105,58	65	120	23		* 6220	303,71	100	180	34	
* 6213-2Z/C3	105,58	65	120	23		* 6220/C3	303,71	100	180	34	
* 6213-RS1	***	65	120	23		* 6220-2RS1	394,60	100	180	34	
* 6213-Z	***	65	120	23		* 6220-2Z	349,13	100	180	34	
* 62213-2RS1	***	65	120	31		* 6220-Z	***	100	180	34	
* 6214	102,12	70	125	24		* 6221	***	105	190	36	
* 6214/C3	102,12	70	125	24		* 6221-2Z	***	105	190	36	
* 6214-2RS1	128,31	70	125	24		* 6222	440,61	110	200	38	
* 6214-2RS1/C3	132,68	70	125	24		* 6222 MA/C3B20	***	110	200	38	
* 6214-2Z	120,96	70	125	24		* 6222/C3	440,61	110	200	38	
* 6214-2Z/C3	120,96	70	125	24		* 6222-2Z	***	110	200	38	
* 6214-RS1	***	70	125	24		6224	565,18	120	215	40	
* 6214-Z	***	70	125	24		6224/C3	***	120	215	40	
* 62214-2RS1	***	70	125	31		6226	682,80	130	230	40	
* 6215	120,72	75	130	25		6226/C3	682,80	130	230	40	
* 6215/C3	120,72	75	130	25		6228	922,61	140	250	42	
* 6215-2RS1	151,79	75	130	25		6228/C3	***	140	250	42	
* 6215-2RS1/C3	156,95	75	130	25		6230	***	150	270	45	
* 6215-2Z	143,11	75	130	25		6232 M	***	160	290	48	
* 6215-2Z/C3	143,11	75	130	25		6234 M	***	170	310	52	
* 6215-RS1	***	75	130	25		6236 M	***	180	320	52	
* 6215-Z	***	75	130	25		638/4-2Z	18,02	4	9	4	10
62312-2RS1	376,47	60	130	46		638/5-2Z	***	5	11	5	10
* 6216	141,26	80	140	26		634-2Z	10,56	4	16	5	10
* 6216/C3	141,26	80	140	26		638/8-2Z	21,20	8	16	6	10
* 6216-2RS1	177,60	80	140	26		* 635	***	5	19	6	10
* 6216-2Z	167,51	80	140	26		* 635-2Z	8,77	5	19	6	10
* 6216-2Z/C3	167,51	80	140	26		63800-2Z	22,75	10	19	7	10
* 6216-RS1	***	80	140	26		* 6300	***	10	35	11	10
* 6216-Z	***	80	140	26		* 6300-2RSH	12,55	10	35	11	10
* 6217	177,38	85	150	28		* 6300-2RSH/C3	12,55	10	35	11	10
* 6217/C3	177,38	85	150	28		* 6300-2Z	11,08	10	35	11	10
* 6217-2RS1	230,52	85	150	28		* 6300-2Z/C3	11,08	10	35	11	10
* 6217-2Z	204,23	85	150	28		* 6300-Z	***	10	35	11	10
* 6217-2Z/C3	204,23	85	150	28		* 6301	***	12	37	12	10
* 6217-Z	***	85	150	28		* 6301-2RSH	12,89	12	37	12	10

* = Explorer



Deep groove ball bearings
Rillenkugellager
Roulements rigides à billes
Cuscinetti radiali a sfere
Rodamientos rígidos de bolas
Groefkogellagers

Ένσφαιρα ρουλεμάν βαθέως αύλακος
Urakuulalaakerit
Rolamentos rígidos de esferas
Sporrkuglelejer
Spårkullager
Sporkulelager

	€	d	D	B	min		€	d	D	B	min
* 6301-2RSH/C3	12,89	12	37	12	10	* 6307/C3	31,96	35	80	21	5
* 6301-2Z	11,37	12	37	12	10	* 6307-2RS1	41,59	35	80	21	5
* 6301-2Z/C3	11,37	12	37	12	10	* 6307-2RS1/C3	41,59	35	80	21	5
* 6301-RSH	***	12	37	12	10	* 6307-2Z	36,74	35	80	21	5
* 6301-Z	***	12	37	12	10	* 6307-2Z/C3	36,74	35	80	21	5
* 6302	10,75	15	42	13	10	* 6307-RS1	***	35	80	21	5
* 6302-2RSH	13,94	15	42	13	10	* 6307-Z	***	35	80	21	5
* 6302-2RSH/C3	13,94	15	42	13	10	* 6308	45,23	40	90	23	5
* 6302-2Z	12,37	15	42	13	10	* 6308/C3	45,23	40	90	23	5
* 6302-2Z/C3	12,37	15	42	13	10	* 6308-2RS1	58,82	40	90	23	5
* 6302-RSH	***	15	42	13	10	* 6308-2RS1/C3	58,82	40	90	23	5
* 6302-Z	***	15	42	13	10	* 6308-2Z	51,97	40	90	23	5
* 6303	12,15	17	47	14	10	* 6308-2Z/C3	51,97	40	90	23	5
* 6303-2RSH	15,80	17	47	14	10	* 6308-RS1	***	40	90	23	5
* 6303-2RSH/C3	15,80	17	47	14	10	* 6308-Z	***	40	90	23	5
* 6303-2Z	13,97	17	47	14	10	* 6309	57,07	45	100	25	5
* 6303-2Z/C3	13,97	17	47	14	10	* 6309/C3	57,07	45	100	25	5
* 6303-RSH	***	17	47	14	10	* 6309-2RS1	74,17	45	100	25	5
* 6303-Z	***	17	47	14	10	* 6309-2RS1/C3	74,17	45	100	25	5
* 6304	14,08	20	52	15	10	* 6309-2Z	65,62	45	100	25	5
* 6304/C3	14,64	20	52	15	10	* 6309-2Z/C3	65,62	45	100	25	5
* 6304-2RSH	18,29	20	52	15	10	* 6309-RS1	***	45	100	25	5
* 6304-2RSH/C3	18,29	20	52	15	10	* 6309-Z	***	45	100	25	5
* 6304-2Z	16,19	20	52	15	10	* 6310	75,76	50	110	27	
* 6304-2Z/C3	16,19	20	52	15	10	* 6310/C3	75,76	50	110	27	
* 6304-RSH	***	20	52	15	10	* 6310-2RS1	98,48	50	110	27	
* 6304-Z	***	20	52	15	10	* 6310-2RS1/C3	98,48	50	110	27	
63/22	***	22	56	16	5	* 6310-2Z	87,11	50	110	27	
* 6305	17,71	25	62	17	5	* 6310-2Z/C3	87,11	50	110	27	
* 6305/C3	17,71	25	62	17	5	* 6310-RS1	***	50	110	27	
* 6305-2RS1	23,03	25	62	17	5	* 6310-Z	***	50	110	27	
* 6305-2RS1/C3	23,03	25	62	17	5	* 6311	95,02	55	120	29	
* 6305-2Z	20,36	25	62	17	5	* 6311/C3	95,02	55	120	29	
* 6305-2Z/C3	20,36	25	62	17	5	* 6311-2RS1	123,24	55	120	29	
* 6305-RS1	***	25	62	17	5	* 6311-2RS1/C3	123,24	55	120	29	
* 6305-Z	***	25	62	17	5	* 6311-2Z	109,03	55	120	29	
* 6306	23,81	30	72	19	5	* 6311-2Z/C3	109,03	55	120	29	
* 6306/C3	24,63	30	72	19	5	* 6311-RS1	***	55	120	29	
* 6306-2RS1	30,89	30	72	19	5	* 6311-Z	***	55	120	29	
* 6306-2RS1/C3	30,89	30	72	19	5	* 6312	120,37	60	130	31	
* 6306-2Z	27,40	30	72	19	5	* 6312/C3	120,37	60	130	31	
* 6306-2Z/C3	27,40	30	72	19	5	* 6312-2RS1	156,41	60	130	31	
* 6306-RS1	***	30	72	19	5	* 6312-2RS1/C3	156,41	60	130	31	
* 6306-Z	***	30	72	19	5	* 6312-2Z	138,64	60	130	31	
* 6307	31,96	35	80	21	5	* 6312-2Z/C3	138,64	60	130	31	

* = Explorer

Ένσφαιρα ρουλεμάν βαθέως αύλακος

Urakuulalaakerit

Rolamentos rígidos de esferas

Spørkuglelejer

Spårkullager

Spørkulelager

Deep groove ball bearings

Rillenkugellager

Roulements rigides à billes

Cuscinetti radiali a sfera

Rodamientos rígidos de bolas

Groefkogellagers

	€	d	D	B	min		€	d	D	B	min
* 6312-RS1	***	60	130	31		6320/C3	590,91	100	215	47	
* 6312-Z	***	60	130	31		6321	***	105	225	49	
* 6313	166,71	65	140	33		6321/C3	789,90	105	225	49	
* 6313/C3	161,23	65	140	33		6322	911,20	110	240	50	
* 6313-2RS1	209,31	65	140	33		6322 M/C3	1440,67	110	240	50	
* 6313-2RS1/C3	209,31	65	140	33		6322/C3	885,54	110	240	50	
* 6313-2Z	191,85	65	140	33		6324	***	120	260	55	
* 6313-2Z/C3	185,53	65	140	33		6324 M/C3	1749,13	120	260	55	
* 6313-Z	***	65	140	33		6324/C3	1074,60	120	260	55	
* 6314	193,59	70	150	35		6326 M	***	130	280	58	
* 6314/C3	193,59	70	150	35		6326 M/C3	2062,41	130	280	58	
* 6314-2RS1	251,72	70	150	35		6328 M	***	140	300	62	
* 6314-2RS1/C3	251,72	70	150	35		6328 M/C3	2379,21	140	300	62	
* 6314-2Z	230,41	70	150	35		6330 M/C3	2988,60	150	320	65	
* 6314-2Z/C3	222,83	70	150	35							
* 6314-Z	***	70	150	35		6403	***	17	62	17	5
* 6315	237,34	75	160	37		6404	***	20	72	19	5
* 6315/C3	229,52	75	160	37		6405	69,95	25	80	21	5
* 6315-2RS1	308,61	75	160	37		6406	87,98	30	90	23	5
* 6315-2RS1/C3	308,61	75	160	37		6407	106,22	35	100	25	5
* 6315-2Z	281,27	75	160	37		6408	131,46	40	110	27	
* 6315-2Z/C3	281,27	75	160	37		6409	160,68	45	120	29	
* 6315-Z	***	75	160	37		6409/C3	160,68	45	120	29	
* 6316	278,04	80	170	39		6410	188,65	50	130	31	
* 6316 M/C3	***	80	170	39		6410/C3	188,65	50	130	31	
* 6316/C3	278,04	80	170	39		6411	225,07	55	140	33	
* 6316/C4	325,38	80	170	39		6411/C3	225,07	55	140	33	
* 6316-2RS1	384,73	80	170	39		6412	270,64	60	150	35	
* 6316-2RS1/C3	384,73	80	170	39		6413	***	65	160	37	
* 6316-2Z	330,83	80	170	39		6413/C3	***	65	160	37	
* 6316-2Z/C3	330,83	80	170	39		6414	***	70	180	42	
* 6316-Z	***	80	170	39		6415	***	75	190	45	
* 6317	338,35	85	180	41		6416	***	80	200	48	
* 6317/C3	327,21	85	180	41		6417	***	85	210	52	
* 6317-2Z	***	85	180	41		6418	***	90	225	54	
* 6317-2Z/C3	400,48	85	180	41							
* 6318	410,86	90	190	43							
* 6318/C3	397,34	90	190	43							
* 6318-2RS1	***	90	190	43							
* 6318-2Z	***	90	190	43							
* 6318-2Z/C3	***	90	190	43							
* 6319	***	95	200	45							
* 6319/C3	490,83	95	200	45							
* 6319-2Z/C3	***	95	200	45							
6320	611,03	100	215	47							

* = Explorer



Deep groove ball bearings
 Rillenkugellager
 Roulements rigides à billes
 Cuscinetti radiali a sfera
 Rodamientos rígidos de bolas
 Groefkogellagers

Ένσφαιρα ρουλεμάν βαθέως αύλακος
 Urakuulalaakerit
 Rolamentos rígidos de esferas
 Sporkuglelejer
 Spårkullager
 Sporkulelager

	€	d	D	B	min		€	d	D	B	min
* 16002	14,05	15	32	8	10	618/4	***	4	9	2,5	10
* 16002-2Z	15,21	15	32	8	10	618/5	14,42	5	11	3	10
* 16003	13,73	17	35	8	10	618/6	14,42	6	13	3,5	10
* 16003-2Z	15,30	17	35	8	10	618/7	***	7	14	3,5	10
* 16004	15,11	20	42	8	10	618/8	15,04	8	16	4	10
* 16005	16,61	25	47	8	10	618/9	15,67	9	17	4	10
* 16006	19,48	30	55	9	5	61800	19,13	10	19	5	10
* 16007	22,45	35	62	9	5	61800-2RS1	21,90	10	19	5	10
* 16008	26,11	40	68	9	5	61800-2Z	21,90	10	19	5	10
* 16009	33,71	45	75	10	5	61801	18,71	12	21	5	10
* 16010	38,43	50	80	10	5	61801-2RS1	21,44	12	21	5	10
* 16011	52,22	55	90	11	5	61801-2Z	21,44	12	21	5	10
* 16012	59,49	60	95	11	5	61802	***	15	24	5	10
* 16013	69,26	65	100	11	5	61802-2RS1	22,08	15	24	5	10
* 16014	84,65	70	110	13		61802-2Z	22,08	15	24	5	10
* 16015	94,21	75	115	13		61803	***	17	26	5	10
* 16016	110,32	80	125	14		61803-2RS1	25,12	17	26	5	10
* 16017	***	85	130	14		61803-2Z	***	17	26	5	10
* 16018	138,01	90	140	16		61804	22,73	20	32	7	10
* 16019	***	95	145	16		61804-2RS1	28,62	20	32	7	10
* 16020	170,81	100	150	16		61804-2RZ	28,62	20	32	7	10
* 16021	***	105	160	18		61805	26,31	25	37	7	10
* 16022	***	110	170	19		61805-2RS1	32,65	25	37	7	10
* 16024	279,46	120	180	19		61805-2RZ	32,65	25	37	7	10
* 16026	***	130	200	22		61806	***	30	42	7	10
16028	***	140	210	22		61806-2RS1	46,99	30	42	7	10
16030	***	150	225	24		61806-2RZ	***	30	42	7	10
16032	***	160	240	25		61807	***	35	47	7	10
16034	***	170	260	28		61807-2RS1	54,03	35	47	7	10
16036	***	180	280	31		61808	50,15	40	52	7	10
16038	***	190	290	31		61808-2RS1	59,05	40	52	7	10
16040	***	200	310	34		61809	59,75	45	58	7	5
16044	***	220	340	37		61809-2RS1	69,68	45	58	7	5
						61809-2RZ	***	45	58	7	5
						61810	***	50	65	7	5
* 16100	***	10	28	8	10	61810-2RS1	79,24	50	65	7	5
* 16100-2Z	16,47	10	28	8	10	61810-2RZ	***	50	65	7	5
* 16101	***	12	30	8	10	61811	***	55	72	9	5
* 16101-2Z	16,66	12	30	8	10	61811-2RS1	96,45	55	72	9	5
						61811-2RZ	***	55	72	9	5
						61812	***	60	78	10	5
						61812-2RS1	110,76	60	78	10	5
						61812-2RZ	***	60	78	10	5
						61813	***	65	85	10	5
						61813-2RS1	125,69	65	85	10	5

* = Explorer

Ένσφαιρα ρουλεμάν βαθύς αύλακος

Urakuulalaakerit

Rolamentos rígidos de esferas

Spørkuglelejer

Spårkullager

Sporkulelager

Deep groove ball bearings

Rillenkugellager

Roulements rigides à billes

Cuscinetti radiali a sfera

Rodamientos rígidos de bolas

Groefkogellagers

	€	d	D	B	min		€	d	D	B	min
61814	***	70	90	10	5	61900-2RS1	21,04	10	22	6	10
61814-2RS1	134,50	70	90	10	5	61900-2Z	21,04	10	22	6	10
61815	***	75	95	10	5	61901	***	12	24	6	10
61815-2RS1	153,54	75	95	10	5	61901-2RS1	20,99	12	24	6	10
61816	***	80	100	10	5	61901-2Z	20,99	12	24	6	10
61816-2RS1	169,93	80	100	10	5	61902	***	15	28	7	10
61817	***	85	110	13		61902-2RS1	23,22	15	28	7	10
61817-2RS1	212,62	85	110	13		61902-2RZ	23,22	15	28	7	10
61818	***	90	115	13		61902-2Z	23,22	15	28	7	10
61818-2RS1	244,75	90	115	13		61903	***	17	30	7	10
61820	226,69	100	125	13		61903-2RS1	23,78	17	30	7	10
61820-2RS1	277,49	100	125	13		61903-2Z	23,78	17	30	7	10
61821	***	105	130	13		61904	***	20	37	9	10
61821-2RS1	***	105	130	13		61904-2RS1	28,42	20	37	9	10
61822	271,48	110	140	16		61904-2RZ	28,42	20	37	9	10
61822-2RS1	321,62	110	140	16		61905	***	25	42	9	10
61824	318,28	120	150	16		61905-2RS1	36,95	25	42	9	10
61824-2RS1	385,14	120	150	16		61905-2RZ	36,95	25	42	9	10
61826	***	130	165	18		61906	***	30	47	9	10
61826-2RS1	462,00	130	165	18		61906-2RS1	47,48	30	47	9	10
61828	452,02	140	175	18		61906-2RZ	***	30	47	9	10
61828-2RS1	550,30	140	175	18		61907	***	35	55	10	5
61830 MA	792,71	150	190	20		61907-2RZ	64,45	35	55	10	5
61832 MA	880,37	160	200	20		61908	***	40	62	12	5
61834	715,45	170	215	22		61908-2RS1	82,94	40	62	12	5
61836 MA	***	180	225	22		61908-2RZ	86,67	40	62	12	5
61838 MA	1173,35	190	240	24		61909	***	45	68	12	5
61840 MA	1299,27	200	250	24		61909-2RS1	100,47	45	68	12	5
61844 MA	1537,50	220	270	24		61909-2RZ	***	45	68	12	5
61848 MA	1855,14	240	300	28		61910	***	50	72	12	5
61852 MA	***	260	320	28		61910-2RS1	108,18	50	72	12	5
61856 MA	***	280	350	33		61911	***	55	80	13	5
61860 MA	***	300	380	38		61911-2RS1	131,17	55	80	13	5
61864 MA	***	320	400	38		61912	***	60	85	13	5
						61912-2RS1	131,53	60	85	13	5
619/4-2Z	***	4	11	4	10	61913	***	65	90	13	5
619/5	***	5	13	4	10	61914	***	70	100	16	5
619/5-2Z	18,02	5	13	4	10	61915	***	75	105	16	
619/6-2Z	18,02	6	15	5	10	61916	***	80	110	16	
619/7-2Z	***	7	17	5	10	61916-2RS1	178,91	80	110	16	
619/8-2RS1	***	8	19	6	10						
619/8-2Z	18,83	8	19	6	10						
619/9	***	9	20	6	10						
619/9-2Z	***	9	20	6	10						
61900	***	10	22	6	10						

* = Explorer

SKF

Deep groove ball bearings
Rillenkugellager
Roulements rigides à billes
Cuscinetti radiali a sfera
Rodamientos rígidos de bolas
Groefkogellagers

Ένσφαιρα ρουλεμάν βαθέως αύλακος
Urakuulalaakerit
Rolamentos rígidos de esferas
Sporkuglelejer
Spårkullager
Sporkulelager

	€	d	D	B	min		€	d	D	B	min
* 630/8-2RS1	24,96	8	22	11	10	E2.6306-2Z/C3	***	30	72	19	5
63000-2RS1	24,41	10	26	12	10	E2.6307-2Z/C3	***	35	80	21	5
* 63001-2RS1	24,37	12	28	12	10	E2.6308-2Z/C3	***	40	90	23	5
* 63002-2RS1	26,64	15	32	13	10	E2.6309-2Z/C3	***	45	100	25	5
* 63003-2RS1	28,48	17	35	14	10	E2.6310-2Z/C3	***	50	110	27	
63004-2RS1	30,25	20	42	16	10	E2.6311-2Z/C3	***	55	120	29	
63005-2RS1	31,43	25	47	16	10	E2.6312-2Z/C3	***	60	130	31	
63006-2RS1	43,73	30	55	19	5						
63007-2RS1	46,23	35	62	20	5						
63008-2RS1	53,79	40	68	21	5						
63009-2RS1	81,70	45	75	23	5						
63010-2RS1	98,63	50	80	23	5						
E2.6000-2Z/C3	***	10	26	8	10						
E2.6001-2Z/C3	***	12	28	8	10						
E2.6002-2Z/C3	***	15	32	9	10						
E2.6003-2Z/C3	***	17	35	10	10						
E2.6004-2Z/C3	***	20	42	12	10						
E2.6005-2Z/C3	***	25	47	12	10						
E2.6006-2Z/C3	***	30	55	13	5						
E2.607-2Z/C3	***	7	19	6	10						
E2.608-2Z/C3	***	8	22	7	10						
E2.609-2Z/C3	***	9	24	7	10						
E2.6200-2Z/C3	***	10	30	9	10						
E2.6201-2Z/C3	***	12	32	10	10						
E2.6202-2Z/C3	***	15	35	11	10						
E2.6203-2Z/C3	***	17	40	12	10						
E2.6204-2Z/C3	***	20	47	14	10						
E2.6205-2Z/C3	***	25	52	15	5						
E2.6206-2Z/C3	***	30	62	16	5						
E2.6207-2Z/C3	***	35	72	17	5						
E2.6208-2Z/C3	***	40	80	18	5						
E2.6209-2Z/C3	***	45	85	19	5						
E2.625-2Z/C3	***	5	16	5	10						
E2.626-2Z/C3	***	6	19	6	10						
E2.627-2Z/C3	***	7	22	7	10						
E2.629-2Z/C3	***	9	26	8	10						
E2.6300-2Z/C3	***	10	35	11	10						
E2.6301-2Z/C3	***	12	37	12	10						
E2.6302-2Z/C3	***	15	42	13	10						
E2.6303-2Z/C3	***	17	47	14	10						
E2.6304-2Z/C3	***	20	52	15	10						
E2.6305-2Z/C3	***	25	62	17	5						

* = Explorer

	€	d	D	B	min		€	d	D	B	min
4200 ATN9	41,83	10	30	14	10	625-2RZTN9/HC5C3WTF1	***	5	16	5	10
4201 ATN9	41,89	12	32	14	10	626-2RSLTN9/HC5C3WTF1	***	6	19	6	10
4202 ATN9	43,43	15	35	14	10	607-2RSLTN9/HC5C3WTF1	***	7	19	6	10
4203 ATN9	47,33	17	40	16	10	627-2RSLTN9/HC5C3WTF1	***	7	22	7	10
4204 ATN9	49,33	20	47	18	10	608-2RSLTN9/HC5C3WTF1	***	8	22	7	10
4205 ATN9	52,45	25	52	18	10	6000-2RSLTN9/HC5C3WT	***	10	26	8	10
4206 ATN9	60,69	30	62	20	5	6200-2RSLTN9/HC5C3WT	***	10	30	9	10
4207 ATN9	74,80	35	72	23	5	6001-2RSLTN9/HC5C3WT	***	12	28	8	10
4208 ATN9	86,38	40	80	23	5	6201-2RSLTN9/HC5C3WT	***	12	32	10	10
4209 ATN9	***	45	85	23	5	6002-2RSLTN9/HC5C3WT	***	15	32	9	10
4210 ATN9	110,19	50	90	23	5	6202-2RSLTN9/HC5C3WT	***	15	35	11	10
4211 ATN9	***	55	100	25		6003-2RSLTN9/HC5C3WT	***	17	35	10	10
4212 ATN9	189,45	60	110	28		6203-2RSLTN9/HC5C3WT	***	17	40	12	10
4213 ATN9	***	65	120	31		6004-2RSLTN9/HC5C3WT	***	20	42	12	10
4214 ATN9	***	70	125	31		6204-2RSLTN9/HC5C3WT	***	20	47	14	10
4215 ATN9	***	75	130	31		6005-2RSLTN9/HC5C3WT	***	25	47	12	10
						6205-2RSLTN9/HC5C3WT	***	25	52	15	10
						6006-2RZTN9/HC5C3WT	***	30	55	13	5
						6206-2RZTN9/HC5C3WT	***	30	62	16	5
						6007-2RZTN9/HC5C3WT	***	35	62	14	5
4302 ATN9	***	15	42	17	10	6207-2RZTN9/HC5C3WT	***	35	72	17	5
4303 ATN9	***	17	47	19	10	6008-2RZTN9/HC5C3WT	***	40	68	15	5
4304 ATN9	***	20	52	21	10	6208-2RZTN9/HC5C3WT	***	40	80	18	5
4305 ATN9	74,29	25	62	24	5	6209-2RZTN9/HC5C3WT	***	45	85	19	5
4306 ATN9	89,28	30	72	27	5	6309-2RS1TN9/HC5C3WT	***	45	100	25	5
4307 ATN9	106,23	35	80	31	5	6210-2RS1/HC5C3WT	***	50	90	20	5
4308 ATN9	134,79	40	90	33	5	6212-2RS1/HC5C3WT	***	60	110	22	5
4310 ATN9	***	50	110	40		6213-2RS1/HC5C3WT	***	65	120	23	
4311 ATN9	***	55	120	43		6214-2RS1/HC5C3WT	***	70	125	24	
4312 ATN9	***	60	130	46							

Deep groove ball bearings
Rillenkugellager
Roulements rigides à billes
Cuscinetti radiali a sfera
Rodamientos rígidos de bolas
Groefkogellagers

Ένσφαιρα ρουλεμάν βαθέως αύλακος
Urakuulalaakerit
Rolamentos rígidos de esferas
Sporkuglelejer
Spårkullager
Sporkulelager

	€	d	D	B	min		€	d	D	B	min
6214 M/C4VL0241	***	70	125	24		W 607-2RS1	***	7	19	6	10
6215/C3VL0241	***	75	130	25		W 608-2RS1	28,14	8	22	7	10
6216/C3VL0241	***	80	140	26		W 609-2RS1	***	9	24	7	10
6217/C3VL0241	***	85	150	28		W 6000-2RS1	26,43	10	26	8	10
6218/C3VL0241	***	90	160	30		W 6001-2RS1	27,90	12	28	8	10
6219/C3VL0241	***	95	170	32		W 6002-2RS1	34,14	15	32	9	10
6220/C3VL0241	***	100	180	34		W 6003-2RS1	40,43	17	35	10	10
6222/C3VL0241	***	110	200	38		W 6004-2RS1	52,77	20	42	12	10
6224/C3VL0241	***	120	215	40		W 6005-2RS1	66,73	25	47	12	10
6230/C3VL2071	***	150	270	45		W 6006-2RS1	99,58	30	55	13	5
6314/C3VL0241	***	70	150	35		W 6007-2RS1	149,68	35	62	14	5
6315/C3VL0241	***	75	160	37		W 6008-2RS1	224,48	40	68	15	5
6316/C3VL0241	***	80	170	39		W 6009-2RS1	***	45	76	16	5
6317/C3VL0241	***	85	180	41		W 6010-2RS1	***	50	80	16	5
6318/C3VL0241	***	90	190	43							
6319/C3VL0241	***	95	200	45		W 624-2RS1	***	4	13	5	10
6320/C3VL0241	***	100	215	47		W 625-2RS1	***	5	16	5	10
6322/C3VL0241	***	110	240	50		W 625-2Z	***	5	16	5	10
6324/C3VL2071	***	120	260	55		W 626-2RS1	***	6	19	6	10
6326/C3VL2071	***	130	280	58		W 6200-2RS1	33,23	10	30	9	10
6328/C3VL2071	***	140	300	62		W 6201-2RS1	32,59	12	32	10	10
						W 6202-2RS1	35,69	15	35	11	10
						W 6203-2RS1	41,87	17	40	12	10
						W 6204-2RS1	55,87	20	47	14	10
						W 6205-2RS1	65,19	25	52	15	10
361200 R	28,01	10	32	9	10	W 6206-2RS1	113,05	30	62	16	5
361201 R	29,74	12	35	10	10	W 6207-2RS1	186,44	35	72	17	5
361202 R	27,40	15	40	11	10	W 6208-2RS1	228,97	40	80	18	5
361204 R	32,33	20	52	14	10	W 6209-2RS1	***	45	85	19	5
361205 R	52,14	25	62	15	5	W 6210-2RS1	***	50	90	20	5
						W 6300-2RS1	***	10	35	11	10
						W 6301-2RS1	***	12	37	12	10
						W 6302-2RS1	***	15	42	13	10
						W 6303-2RS1	103,85	17	47	14	10
						W 6304-2RS1	122,76	20	52	15	10
						W 6305-2RS1	169,50	25	62	17	5
						W 6306-2RS1	***	30	72	19	5

* = Explorer

Δίσφαιρα αυτορρυθμιζόμενα ρουλεμάν
 Pallomaiset kuulalaakerit
 Rolamentos autocompensadores de esferas
 Sfæriske kuglelejer
 Sfäriska kullager
 Sfæriske kulelager

Self-aligning ball bearings
 Pendelkugellager
 Roulements à rotule sur billes
 Cuscinetti orientabili a sfera
 Rodamientos de bolas a rótula
 Tweerijge zich instellende kogellagers

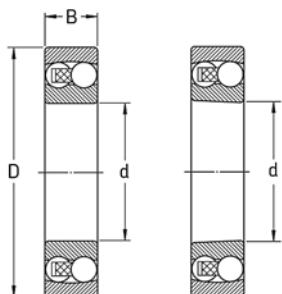

10	34
12	34
13	34
22	35
23	36

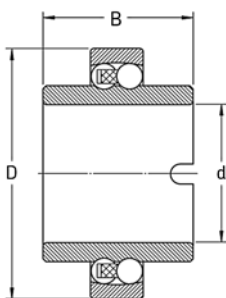

112	36
-----	-------	----

Self-aligning ball bearings
Pendelkugellager
Roulements à rotule sur billes
Cuscinetti orientabili a sfera
Rodamientos de bolas a rótula
Tweerijige zich instellende kogellagers

Δίσφαιρα αυτορρυθμιζόμενα ρουλεμάν
Pallomaiset kuulalaakerit
Rolamentos autocompensadores de esferas
Sfæriske kuglelejer
Sfäriska kullager
Sfæriske kulelager

	€	d	D	B	min		€	d	D	B	min
108 TN9	29,99	8	22	7	10	1216	194,33	80	140	26	
						1216 K	194,33	80	140	26	
						1216 K/C3	194,33	80	140	26	
						1217	***	85	150	28	
						1217 K	242,92	85	150	28	
126 TN9	28,21	6	19	6	10	1217 K/C3	***	85	150	28	
127 TN9	***	7	22	7	10	1218	292,17	90	160	30	
129 TN9	***	9	26	8	10	1218 K	292,17	90	160	30	
1200 ETN9	32,81	10	30	9	10	1218 K/C3	292,17	90	160	30	
1201 ETN9	39,23	12	32	10	10	1219	***	95	170	32	
1202 ETN9	41,05	15	35	11	10	1219 K/C3	***	95	170	32	
1203 ETN9	40,90	17	40	12		1220	413,28	100	180	34	
1204 ETN9	35,23	20	47	14		1220 K	413,28	100	180	34	
1204 ETN9/C3	***	20	47	14		1220 K/C3	413,28	100	180	34	
1205 EKTN9/C3	***	25	52	15	5	1222	***	110	200	38	
1205 ETN9	37,57	25	52	15	5	1222 K	570,99	110	200	38	
1206 EKTN9	***	30	62	16	5	1222 K/C3	570,99	110	200	38	
1206 EKTN9/C3	43,28	30	62	16	5	1224 M	***	120	215	44,5	
1206 ETN9	40,66	30	62	16	5	1226 M	***	130	230	47,1	
1206 ETN9/C3	***	30	62	16	5						
1207 EKTN9	46,89	35	72	17	5	135 TN9	***	5	19	6	10
1207 EKTN9/C3	46,89	35	72	17	5	1301 ETN9	***	12	37	12	10
1207 ETN9	49,92	35	72	17	5	1302 ETN9	***	15	42	13	10
1208 EKTN9	58,37	40	80	18	5	1303 ETN9	***	17	47	14	
1208 EKTN9/C3	58,37	40	80	18	5	1304 ETN9	45,14	20	52	15	5
1208 ETN9	58,37	40	80	18	5	1305 EKTN9	***	25	62	17	5
1209 EKTN9	61,71	45	85	19	5	1305 ETN9	52,55	25	62	17	5
1209 EKTN9/C3	61,71	45	85	19	5	1306 EKTN9/C3	***	30	72	19	5
1209 ETN9	63,53	45	85	19	5	1306 ETN9	64,98	30	72	19	5
1210 EKTN9	72,89	50	90	20	5	1307 EKTN9/C3	***	35	80	21	5
1210 EKTN9/C3	72,89	50	90	20	5	1307 ETN9	75,37	35	80	21	5
1210 ETN9	72,89	50	90	20	5	1308 EKTN9/C3	***	40	90	23	5
1211 EKTN9	89,22	55	100	21	5	1308 ETN9	91,87	40	90	23	5
1211 EKTN9/C3	86,64	55	100	21	5	1309 EKTN9	***	45	100	25	5
1211 ETN9	***	55	100	21	5	1309 EKTN9/C3	113,84	45	100	25	5
1212 EKTN9	***	60	110	22		1309 ETN9	113,84	45	100	25	5
1212 EKTN9/C3	107,93	60	110	22		1310 EKTN9/C3	***	50	110	27	
1212 ETN9	107,93	60	110	22		1310 ETN9	141,19	50	110	27	
1213 EKTN9	130,17	65	120	23		1311 EKTN9	168,26	55	120	29	
1213 EKTN9/C3	126,45	65	120	23		1311 EKTN9/C3	168,26	55	120	29	
1213 ETN9	***	65	120	23		1311 ETN9	***	55	120	29	
1214 ETN9	***	70	125	24		1312 EKTN9/C3	***	60	130	31	
1215	***	75	130	25		1312 ETN9	208,99	60	130	31	
1215 K	164,38	75	130	25		1313 EKTN9	259,89	65	140	33	
1215 K/C3	164,38	75	130	25		1313 EKTN9/C3	259,89	65	140	33	

Δίσφαιρα αυτορρϋθμισα ρουλεμάν
 Pallomaiset kuulalaakerit
 Rolamentos autocompensadores de esferas
 Sfæriske kuglelejer
 Sfäriska kullager
 Sfæriske kulelager

Self-aligning ball bearings
 Pendelkugellager
 Roulements à rotule sur billes
 Cuscinetti orientabili a sfera
 Rodamientos de bolas a rótula
 Tweerjige zich instellende kogellagers

	€	d	D	B	min		€	d	D	B	min
1313 ETN9	***	65	140	33		2200 E-2RS1TN9	43,76	10	30	14	10
1314	325,71	70	150	35		2200 ETN9	***	10	30	14	10
1315	***	75	160	37		2201 E-2RS1TN9	44,56	12	32	14	10
1315 K/C3	***	75	160	37		2201 ETN9	50,01	12	32	14	10
1316	***	80	170	39		2202 E-2RS1TN9	45,42	15	35	14	10
1316 K/C3	439,04	80	170	39		2202 ETN9	40,92	15	35	14	10
1317	***	85	180	41		2203 E-2RS1TN9	48,38	17	40	16	
1317 K/C3	***	85	180	41		2203 ETN9	41,71	17	40	16	
1318	***	90	190	45		2204 E-2RS1TN9	52,22	20	47	18	
1318 K/C3	***	90	190	45		2204 ETN9	42,94	20	47	18	
1319	***	95	200	48		2205 E-2RS1KTN9/C3	***	25	52	18	5
1320	***	100	215	47		2205 E-2RS1TN9	55,16	25	52	18	5
1320 K/C3	***	100	215	47		2205 E-2RS1TN9/C3	66,21	25	52	18	5
						2205 EKTN9/C3	***	25	52	18	5
						2205 ETN9	48,69	25	52	18	5
						2206 E-2RS1KTN9	70,44	30	62	20	5
						2206 E-2RS1KTN9/C3	70,44	30	62	20	5
						2206 E-2RS1TN9	63,83	30	62	20	5
						2206 EKTN9/C3	***	30	62	20	5
						2206 ETN9	52,58	30	62	20	5
						2207 E-2RS1KTN9	***	35	72	23	5
						2207 E-2RS1KTN9/C3	***	35	72	23	5
						2207 E-2RS1TN9	76,61	35	72	23	5
						2207 EKTN9	***	35	72	23	5
						2207 EKTN9/C3	63,08	35	72	23	5
						2207 ETN9	63,08	35	72	23	5
						2208 E-2RS1KTN9	***	40	80	23	5
						2208 E-2RS1KTN9/C3	***	40	80	23	5
						2208 E-2RS1TN9	90,83	40	80	23	5
						2208 EKTN9	***	40	80	23	5
						2208 EKTN9/C3	71,97	40	80	23	5
						2208 ETN9	71,97	40	80	23	5
						2209 E-2RS1KTN9	109,50	45	85	23	5
						2209 E-2RS1KTN9/C3	***	45	85	23	5
						2209 E-2RS1TN9	109,50	45	85	23	5
						2209 EKTN9	79,15	45	85	23	5
						2209 EKTN9/C3	79,15	45	85	23	5
						2209 ETN9	84,23	45	85	23	5
						2210 E-2RS1KTN9/C3	***	50	90	23	5
						2210 E-2RS1TN9	115,48	50	90	23	5
						2210 EKTN9	94,50	50	90	23	5
						2210 EKTN9/C3	94,50	50	90	23	5
						2210 ETN9	94,50	50	90	23	5
						2211 E-2RS1KTN9/C3	147,39	55	100	25	5
						2211 E-2RS1TN9	147,39	55	100	25	5

Self-aligning ball bearings
Pendelkugellager
Roulements à rotule sur billes
Cuscinetti orientabili a sfera
Rodamientos de bolas a rótula
Tweerijige zich instellende kogellagers

Δίσφαιρα αυτορρυθμιζόμενα ρουλεμάν
Pallomaiset kuulalaakerit
Rolamentos autocompensadores de esferas
Sfæriske kuglelejer
Sfäriska kullager
Sfæriske kulelager

	€	d	D	B	min		€	d	D	B	min
2211 EKTN9	106,54	55	100	25	5	2307 E-2RS1TN9	131,82	35	80	31	5
2211 EKTN9/C3	106,54	55	100	25	5	2307 EKTN9	***	35	80	31	5
2211 ETN9	***	55	100	25	5	2307 EKTN9/C3	105,46	35	80	31	5
2212 E-2RS1TN9	171,67	60	110	28		2307 ETN9	105,46	35	80	31	5
2212 EKTN9	***	60	110	28		2308 E-2RS1TN9	163,13	40	90	33	5
2212 EKTN9/C3	140,49	60	110	28		2308 EKTN9/C3	125,47	40	90	33	5
2212 ETN9	140,49	60	110	28		2308 EM	325,59	40	90	33	5
2213 E-2RS1KTN9/C3	***	65	120	31		2308 ETN9	125,47	40	90	33	5
2213 E-2RS1TN9	***	65	120	31		2309 E-2RS1TN9	***	45	100	36	
2213 EKTN9	159,98	65	120	31		2309 EKTN9/C3	156,19	45	100	36	
2213 EKTN9/C3	159,98	65	120	31		2309 EM	384,13	45	100	36	
2213 ETN9	170,21	65	120	31		2309 EM/C3	***	45	100	36	
2214	***	70	125	31		2309 ETN9	156,19	45	100	36	
2214 E-2RS1TN9	***	70	125	31		2310	201,54	50	110	40	
2215 EKTN9	257,90	75	130	31		2310 E-2RS1TN9	***	50	110	40	
2215 EKTN9/C3	257,90	75	130	31		2310 K/C3	201,54	50	110	40	
2215 ETN9	***	75	130	31		2311	249,11	55	120	43	
2215 ETN9/C3	***	75	130	31		2311 K/C3	249,11	55	120	43	
2216 EKTN9	311,57	80	140	33		2312	307,75	60	130	46	
2216 EKTN9/C3	311,57	80	140	33		2312 K/C3	307,75	60	130	46	
2216 ETN9	311,57	80	140	33		2312/C3	***	60	130	46	
2217	***	85	150	36		2313	***	65	140	48	
2217 K/C3	381,69	85	150	36		2313 K/C3	371,05	65	140	48	
2218	***	90	160	40		2314	460,67	70	150	51	
2218 K	460,10	90	160	40		2315	***	75	160	55	
2218 K/C3	552,17	90	160	40		2315 K/C3	579,95	75	160	55	
2219 KM/P63	***	95	170	43		2316	***	80	170	58	
2220 KM/C3	894,09	100	180	46		2316 K/C3	705,18	80	170	58	
2220 M	***	100	180	46		2316 M	***	80	170	58	
2222 KM/C3	1121,06	110	200	53		2317 KM/C3	1126,19	85	180	60	
2222 M	***	110	200	53		2317 M	***	85	180	60	
						2318 KM/C3	***	90	190	64	
						2318 M	***	90	190	64	
						2320 M	***	100	215	73	
2302 E-2RS1TN9	67,27	15	42	17	10	11206 TN9	***	30	62	48	
2303 E-2RS1TN9	71,39	17	47	19		11207 TN9	110,77	35	72	52	
2304 E-2RS1TN9	71,84	20	52	21	5	11208 TN9	129,18	40	80	56	
2304 TN	***	20	52	21	5	11209 TN9	***	45	85	58	
2305 E-2RS1TN9	88,07	25	62	24	5	11210 TN9	***	50	90	58	
2305 ETN9	72,57	25	62	24	5	11212 TN9	***	60	110	62	
2305 M	211,73	25	62	24	5						
2306 E-2RS1TN9	111,35	30	72	27	5						
2306 K/C3	***	30	72	27	5						
2306 M	***	30	72	27	5						

Ένσφαιρα ρουλεμάν γωνιακής επαφής
 Viistokuulalaakerit
 Rolamentos de esferas de contato angular
 Vinkelkontaktkuglelejer
 Vinkelkontaktkullager
 Vinkelkontaktkulelager

Angular contact ball bearings
 Schrägkugellager
 Roulements à billes à contact oblique
 Cuscinetti obliqui a sfera
 Rodamientos de bolas con contacto angular
 Hoekcontactkogellagers

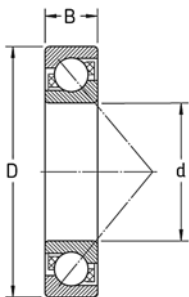

72	38
73	39
74	40

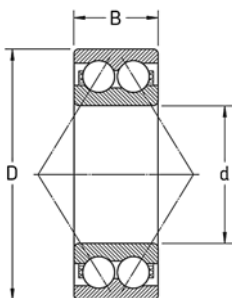

32	40
33	41

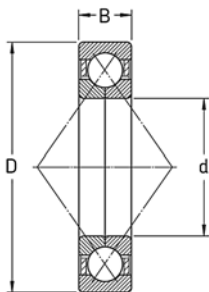

QJ 2	42
QJ 3	43

Angular contact ball bearings
Schrägkugellager
Roulements à billes à contact oblique
Cuscinetti obliqui a sfera
Rodamientos de bolas con contacto angular
Hoekcontactkogellagers

Ένασφαιρα ρουλεμάν γωνιακής επαφής
Viistokulaalaakerit
Rolamentos de esferas de contato angular
Vinkelkontaktkuglelejer
Vinkelkontaktkullager
Vinkelkontaktkulelager

	€	d	D	B	min		€	d	D	B	min
7200 BECBP	***	10	30	9	10	* 7212 BECBP	159,93	60	110	22	5
7200 BEP	29,81	10	30	9	10	** 7212 BEGAP	***	60	110	22	5
7201 BECBP	51,44	12	32	10	10	7212 BEP	117,42	60	110	22	5
7201 BEGAP	***	12	32	10	10	* 7213 BECBM	***	65	120	23	
7201 BEP	29,10	12	32	10	10	* 7213 BECBP	184,70	65	120	23	
* 7202 BECBP	51,31	15	35	11	10	* 7213 BEGAP	***	65	120	23	
* 7202 BEGAP	***	15	35	11	10	7213 BEP	142,11	65	120	23	
7202 BEP	28,59	15	35	11	10	** 7214 BECBM	344,06	70	125	24	
** 7203 BECBM	***	17	40	12	10	* 7214 BECBP	210,67	70	125	24	
* 7203 BECBP	56,77	17	40	12	10	** 7214 BEGAP	***	70	125	24	
** 7203 BEGAP	***	17	40	12	10	7214 BEP	165,08	70	125	24	
7203 BEP	30,36	17	40	12	10	* 7215 BECBM	351,13	75	130	25	
* 7204 BECBM	***	20	47	14	10	* 7215 BECBP	230,73	75	130	25	
* 7204 BECBP	61,34	20	47	14	10	7215 BEP	186,09	75	130	25	
* 7204 BEGAP	***	20	47	14	10	** 7216 BECBM	389,47	80	140	26	
7204 BEP	32,26	20	47	14	10	* 7216 BECBP	270,60	80	140	26	
** 7205 BECBM	***	25	52	15	10	7216 BEP	225,95	80	140	26	
** 7205 BECBP	66,46	25	52	15	10	* 7217 BECBM	***	85	150	28	
** 7205 BEGAP	***	25	52	15	10	* 7217 BECBP	***	85	150	28	
7205 BEP	35,09	25	52	15	10	7217 BEP	273,33	85	150	28	
** 7206 BECBM	***	30	62	16	5	* 7218 BECBM	555,44	90	160	30	
** 7206 BECBP	74,07	30	62	16	5	* 7218 BECBP	383,62	90	160	30	
** 7206 BEGAP	***	30	62	16	5	* 7218 BEGAP	***	90	160	30	
7206 BEP	41,95	30	62	16	5	7218 BEP	330,85	90	160	30	
** 7207 BECBM	***	35	72	17	5	** 7219 BECBM	625,81	95	170	32	
* 7207 BECBP	82,41	35	72	17	5	* 7219 BECBP	***	95	170	32	
** 7207 BEGAP	***	35	72	17	5	7219 BEP	***	95	170	32	
7207 BEP	51,39	35	72	17	5	* 7220 BECBM	650,87	100	180	34	
** 7208 BECBM	***	40	80	18	5	* 7220 BECBP	506,08	100	180	34	
** 7208 BECBP	94,41	40	80	18	5	7220 BEP	450,61	100	180	34	
* 7208 BEGAP	***	40	80	18	5	* 7221 BECBM	753,71	105	190	36	
7208 BEP	59,43	40	80	18	5	* 7221 BECBP	***	105	190	36	
** 7209 BECBM	***	45	85	19	5	7221 BEP	***	105	190	36	
** 7209 BECBP	105,11	45	85	19	5	* 7222 BECBM	861,96	110	200	38	
* 7209 BEGAP	***	45	85	19	5	* 7222 BECBP	***	110	200	38	
7209 BEP	67,87	45	85	19	5	7222 BEP	***	110	200	38	
** 7210 BECBM	173,04	50	90	20	5	7224 BCBM	1052,75	120	215	40	
** 7210 BECBP	114,72	50	90	20	5	7224 BGAM	***	120	215	40	
* 7210 BEGAP	***	50	90	20	5	7226 BCBM	1317,94	130	230	40	
7210 BEP	76,88	50	90	20	5	7226 BGAM	***	130	230	40	
* 7211 BECBM	***	55	100	21	5	7228 BCBM	1676,51	140	250	42	
* 7211 BECBP	136,10	55	100	21	5	7230 BCBM	***	150	270	45	
* 7211 BEGAP	***	55	100	21	5	7230 BGAM	***	150	270	45	
7211 BEP	96,36	55	100	21	5	7232 BCBM	***	160	290	48	
* 7212 BECBM	258,74	60	110	22	5	7234 BCBM	***	170	310	52	

* = Explorer ** = Explorer recommended range

Ένσφαιρα ρουλεμάν γωνιακής επαφής
Viistokuulalaakerit
Rolamentos de esferas de contato angular
Vinkelkontaktkuglelejer
Vinkelkontaktkullager
Vinkelkontaktkulelager

Angular contact ball bearings
Schrägkugellager
Roulements à billes à contact oblique
Cuscinetti obliqui a sfera
Rodamientos de bolas con contacto angular
Hoekcontactkogellagers

	€	d	D	B	min		€	d	D	B	min
7236 BCBM	***	180	320	52		7311 BECBJ	250,99	55	120	29	
						** 7311 BECBM	359,41	55	120	29	
						** 7311 BECBP	205,68	55	120	29	
						** 7311 BEGAM	***	55	120	29	
						** 7311 BEGAP	***	55	120	29	
7301 BEP	***	12	37	12	10	7311 BEP	169,15	55	120	29	
7302 BECBP	***	15	42	13	10	7312 BECBJ	295,83	60	130	31	
7302 BEP	***	15	42	13	10	** 7312 BECBM	448,92	60	130	31	
7303 BECBP	***	17	47	14	10	** 7312 BECBP	258,73	60	130	31	
7303 BEGAP	***	17	47	14	10	** 7312 BEGAM	***	60	130	31	
7303 BEP	37,24	17	47	14	10	** 7312 BEGAP	***	60	130	31	
** 7304 BECBM	***	20	52	15	10	7312 BEP	205,72	60	130	31	
** 7304 BECBP	***	20	52	15	10	7313 BECBJ	399,51	65	140	33	
* 7304 BEGAP	***	20	52	15	10	** 7313 BECBM	458,69	65	140	33	
7304 BEP	38,83	20	52	15	10	** 7313 BECBP	308,85	65	140	33	
** 7305 BECBM	127,63	25	62	17	5	7313 BEGAF	537,42	65	140	33	
** 7305 BECBP	81,41	25	62	17	5	** 7313 BEGAM	***	65	140	33	
** 7305 BEGAP	***	25	62	17	5	** 7313 BEGAP	***	65	140	33	
7305 BEP	46,10	25	62	17	5	7313 BEP	273,33	65	140	33	
** 7306 BECBM	147,50	30	72	19	5	7314 BECBJ	448,22	70	150	35	
** 7306 BECBP	89,91	30	72	19	5	** 7314 BECBM	534,95	70	150	35	
* 7306 BEGAM	***	30	72	19	5	** 7314 BECBP	366,03	70	150	35	
** 7306 BEGAP	***	30	72	19	5	** 7314 BEGAM	***	70	150	35	
7306 BEP	55,52	30	72	19	5	** 7314 BEGAP	***	70	150	35	
** 7307 BECBM	164,54	35	80	21	5	7314 BEP	330,17	70	150	35	
** 7307 BECBP	100,93	35	80	21	5	7315 BECBJ	555,77	75	160	37	
** 7307 BEGAP	***	35	80	21	5	** 7315 BECBM	676,82	75	160	37	
7307 BEP	67,62	35	80	21	5	** 7315 BECBP	483,87	75	160	37	
7308 BECBJ	143,02	40	90	23	5	* 7315 BEGAM	***	75	160	37	
** 7308 BECBM	203,77	40	90	23	5	** 7315 BEGAP	***	75	160	37	
** 7308 BECBP	121,50	40	90	23	5	7315 BEP	415,42	75	160	37	
** 7308 BEGAM	***	40	90	23	5	7316 BECBJ	645,42	80	170	39	
** 7308 BEGAP	***	40	90	23	5	** 7316 BECBM	760,67	80	170	39	
7308 BEP	86,80	40	90	23	5	** 7316 BECBP	558,68	80	170	39	
7309 BECBJ	176,43	45	100	25	5	* 7316 BEGAM	***	80	170	39	
** 7309 BECBM	259,34	45	100	25	5	** 7316 BEGAP	***	80	170	39	
** 7309 BECBP	140,72	45	100	25	5	7316 BEP	487,80	80	170	39	
** 7309 BEGAP	***	45	100	25	5	** 7317 BECBM	829,82	85	180	41	
7309 BEP	106,51	45	100	25	5	** 7317 BECBP	662,17	85	180	41	
7310 BECBJ	219,71	50	110	27	5	7317 BEGAF	891,54	85	180	41	
** 7310 BECBM	309,77	50	110	27	5	** 7317 BEGAM	***	85	180	41	
** 7310 BECBP	178,37	50	110	27	5	7317 BEP	***	85	180	41	
** 7310 BEGAM	***	50	110	27	5	** 7318 BECBM	884,49	90	190	43	
** 7310 BEGAP	***	50	110	27	5	** 7318 BECBP	769,14	90	190	43	
7310 BEP	133,21	50	110	27	5	* 7318 BEGAM	***	90	190	43	

* = Explorer ** = Explorer recommended range

Angular contact ball bearings
Schrägkugellager
Roulements à billes à contact oblique
Cuscinetti obliqui a sfera
Rodamientos de bolas con contacto angular
Hoekcontactkogellagers

Ενσφαιρα ρουλεμάν γωνιακής επαφής
Viistokulaalaakerit
Rolamentos de esferas de contato angular
Vinkelkontaktkuglejer
Vinkelkontaktkullager
Vinkelkontaktkulelager

	€	d	D	B	min		€	d	D	B	min
7318 BEP	***	90	190	43		3200 A-2RS1TN9/MT33	59,70	10	30	14	10
** 7319 BECBM	1142,53	95	200	45		3200 A-2ZTN9/MT33	54,72	10	30	14	10
** 7319 BECBP	893,58	95	200	45		3200 ATN9	49,73	10	30	14	10
** 7319 BEGAM	***	95	200	45		3200 ATN9/C3	***	10	30	14	10
7319 BEP	***	95	200	45		3201 A-2RS1TN9/MT33	60,89	12	32	15,9	10
* 7320 BECBM	1235,43	100	215	47		3201 A-2ZTN9/MT33	55,77	12	32	15,9	10
* 7320 BECBP	1048,62	100	215	47		3201 ATN9	50,70	12	32	15,9	10
* 7320 BEGAM	***	100	215	47		3202 A-2RS1TN9/MT33	61,78	15	35	15,9	10
** 7320 BEGAP	***	100	215	47		3202 A-2ZTN9/MT33	58,29	15	35	15,9	10
7320 BEP	***	100	215	47		3202 ATN9	51,44	15	35	15,9	10
* 7321 BECBM	***	105	225	49		3202 ATN9/C3	***	15	35	15,9	10
* 7321 BECBP	***	105	225	49		3203 A-2RS1TN9/MT33	60,02	17	40	17,5	10
7321 BEP	***	105	225	49		3203 A-2ZTN9/MT33	56,70	17	40	17,5	10
* 7322 BECBM	1750,62	110	240	50		3203 ATN9	53,81	17	40	17,5	10
* 7322 BECBP	1457,32	110	240	50		3203 ATN9/C3	***	17	40	17,5	10
7322 BEP	1366,67	110	240	50	*	3204 A	***	20	47	20,6	10
7324 BCBM	2221,13	120	260	55	**	3204 A/C3	***	20	47	20,6	10
7326 BCBM	***	130	280	58	*	3204 A-2RS1/MT33	***	20	47	20,6	10
7328 BCBM	***	140	300	62	*	3204 A-2RS1TN9/MT33	63,00	20	47	20,6	10
7330 BCBM	***	150	320	65	*	3204 A-2ZTN9/MT33	60,27	20	47	20,6	10
7411 BGM	665,59	55	140	33	*	3204 ATN9	55,24	20	47	20,6	10
7412 BCBM	***	60	150	35	**	3204 ATN9/C3	***	20	47	20,6	10
7413 BCBM	***	65	160	37	*	3205 A	***	25	52	20,6	10
7414 BCBM	***	70	180	42	**	3205 A/C3	***	25	52	20,6	10
					*	3205 A-2RS1/MT33	***	25	52	20,6	10
					*	3205 A-2RS1TN9/MT33	66,40	25	52	20,6	10
					*	3205 A-2ZTN9/MT33	63,64	25	52	20,6	10
					*	3205 ATN9	57,81	25	52	20,6	10
					**	3205 ATN9/C3	***	25	52	20,6	10
					*	3206 A	***	30	62	23,8	5
					**	3206 A/C3	***	30	62	23,8	5
					*	3206 A-2RS1/MT33	***	30	62	23,8	5
					*	3206 A-2RS1TN9/C3MT33	82,71	30	62	23,8	5
					*	3206 A-2RS1TN9/MT33	79,20	30	62	23,8	5
					*	3206 A-2ZTN9/MT33	75,82	30	62	23,8	5
					*	3206 ATN9	68,93	30	62	23,8	5
					**	3206 ATN9/C3	***	30	62	23,8	5
					*	3207 A	***	35	72	27	5
					**	3207 A/C3	***	35	72	27	5
					*	3207 A-2RS1/MT33	***	35	72	27	5
					*	3207 A-2RS1TN9/MT33	98,14	35	72	27	5
					*	3207 A-2ZTN9/MT33	93,83	35	72	27	5
					*	3207 ATN9	81,73	35	72	27	5
					**	3207 ATN9/C3	***	35	72	27	5
					*	3208 A	***	40	80	30,2	5

* = Explorer ** = Explorer recommended range

Ένσφαιρα ρουλεμάν γωνιακής επαφής
Viistokuulalaakerit
Rolamentos de esferas de contato angular
Vinkelkontaktkuglelejer
Vinkelkontaktkullager
Vinkelkontaktkulelager

Angular contact ball bearings
Schrägkugellager
Roulements à billes à contact oblique
Cuscinetti obliqui a sfera
Rodamientos de bolas con contacto angular
Hoekcontactkogellagers

	€	d	D	B	min		€	d	D	B	min
** 3208 A/C3	***	40	80	30,2	5	3219 A/C3	***	95	170	55,6	
* 3208 A-2RS1/MT33	***	40	80	30,2	5	3220 A	822,74	100	180	60,3	
* 3208 A-2RS1TN9/C3MT33	125,26	40	80	30,2	5	3220 A/C3	***	100	180	60,3	
* 3208 A-2RS1TN9/MT33	119,93	40	80	30,2	5	3222 A	***	110	200	69,8	
* 3208 A-2ZTN9/MT33	117,10	40	80	30,2	5	3222 A/C3	***	110	200	69,8	
* 3208 ATN9	104,38	40	80	30,2	5	3302 A-2RS1TN9/MT33	78,69	15	42	19	10
** 3208 ATN9/C3	***	40	80	30,2	5	3302 A-2ZTN9/MT33	***	15	42	19	10
* 3209 A	***	45	85	30,2	5	3302 ATN9	65,68	15	42	19	10
** 3209 A/C3	***	45	85	30,2	5	3302 ATN9/C3	***	15	42	19	10
* 3209 A-2RS1/MT33	***	45	85	30,2	5	3303 A-2RS1TN9/MT33	82,32	17	47	22,2	5
* 3209 A-2RS1TN9/MT33	144,11	45	85	30,2	5	3303 A-2ZTN9/MT33	***	17	47	22,2	5
* 3209 A-2ZTN9/MT33	131,99	45	85	30,2	5	3303 ATN9	69,97	17	47	22,2	5
** 3209 ATN9	120,01	45	85	30,2	5	3303 ATN9/C3	***	17	47	22,2	5
** 3209 ATN9/C3	***	45	85	30,2	5	* 3304 A	***	20	52	22,2	10
* 3210 A	***	50	90	30,2	5	** 3304 A/C3	***	20	52	22,2	10
** 3210 A/C3	***	50	90	30,2	5	* 3304 A-2RS1/MT33	***	20	52	22,2	10
* 3210 A-2RS1/MT33	***	50	90	30,2	5	* 3304 A-2RS1TN9/C3MT33	***	20	52	22,2	10
* 3210 A-2RS1TN9/C3MT33	***	50	90	30,2	5	** 3304 A-2RS1TN9/MT33	88,88	20	52	22,2	10
* 3210 A-2RS1TN9/MT33	156,04	50	90	30,2	5	* 3304 A-2ZTN9/MT33	***	20	52	22,2	10
* 3210 A-2ZTN9/MT33	***	50	90	30,2	5	* 3304 ATN9	74,07	20	52	22,2	10
* 3210 ATN9	130,25	50	90	30,2	5	** 3304 ATN9/C3	***	20	52	22,2	10
** 3210 ATN9/C3	***	50	90	30,2	5	* 3305 A	***	25	62	25,4	5
* 3211 A	183,13	55	100	33,3	5	** 3305 A/C3	***	25	62	25,4	5
** 3211 A/C3	***	55	100	33,3	5	* 3305 A-2RS1TN9/C3MT33	***	25	62	25,4	5
* 3211 A-2RS1/MT33	219,80	55	100	33,3	5	* 3305 A-2RS1TN9/MT33	101,65	25	62	25,4	5
* 3211 ATN9	159,27	55	100	33,3	5	* 3305 A-2ZTN9/MT33	***	25	62	25,4	5
** 3212 A	222,79	60	110	36,5		* 3305 ATN9	88,49	25	62	25,4	5
** 3212 A/C3	237,04	60	110	36,5		** 3305 ATN9/C3	90,15	25	62	25,4	5
* 3212 A-2RS1/MT33	***	60	110	36,5		* 3306 A	***	30	72	30,2	5
* 3212 A-2RS1TN9/MT33	***	60	110	36,5		** 3306 A/C3	***	30	72	30,2	5
* 3212 ATN9	***	60	110	36,5		* 3306 A-2RS1TN9/MT33	127,15	30	72	30,2	5
3213 A	256,42	65	120	38,1		* 3306 A-2ZTN9/MT33	***	30	72	30,2	5
3213 A/C3	***	65	120	38,1		* 3306 ATN9	106,01	30	72	30,2	5
3213 A-2RS1/C3MT33	***	65	120	38,1		** 3306 ATN9/C3	108,01	30	72	30,2	5
3214 A	294,98	70	125	39,7		* 3307 A	138,93	35	80	34,9	5
3214 A/C3	***	70	125	39,7		** 3307 A/C3	***	35	80	34,9	5
3215 A	327,46	75	130	41,3		* 3307 A-2RS1TN9/C3MT33	***	35	80	34,9	5
3215 A/C3	***	75	130	41,3		* 3307 A-2RS1TN9/MT33	148,84	35	80	34,9	5
3216 A	379,14	80	140	44,4		* 3307 A-2ZTN9/MT33	***	35	80	34,9	5
3216 A/C3	***	80	140	44,4		* 3307 ATN9	123,92	35	80	34,9	5
3217 A	466,85	85	150	49,2		** 3307 ATN9/C3	126,23	35	80	34,9	5
3217 A/C3	***	85	150	49,2		3308 DJ1	218,92	35	80	34,9	5
3218 A	556,15	90	160	52,4		* 3308 A	174,41	40	90	36,5	
3218 A/C3	***	90	160	52,4		** 3308 A/C3	***	40	90	36,5	
3219 A	***	95	170	55,6		* 3308 A-2RS1TN9/MT33	186,56	40	90	36,5	

* = Explorer ** = Explorer recommended range

Angular contact ball bearings
Schrägkugellager
Roulements à billes à contact oblique
Cuscinetti obliqui a sfere
Rodamientos de bolas con contacto angular
Hoekcontactkogellagers

Ενσφαιρα ρουλεμάν γωνιακής επαφής
Viistokulaalaakerit
Rolamentos de esferas de contato angular
Vinkelkontaktkuglelejer
Vinkelkontaktkullager
Vinkelkontaktkulelager

	€	d	D	B	min		€	d	D	B	min
* 3308 A-2ZTN9/MT33	***	40	90	36,5		* QJ 203 N2MA/C2L	***	17	40	12	10
* 3308 ATN9	155,58	40	90	36,5		* QJ 206 MA	108,48	30	62	16	5
** 3308 ATN9/C3	158,53	40	90	36,5		* QJ 207 N2MA/C2L	193,71	35	72	17	5
* 3309 A	214,12	45	100	39,7		* QJ 208 MA	***	40	80	18	5
** 3309 A/C3	218,18	45	100	39,7		* QJ 209 MA	136,78	45	85	19	5
* 3309 A-2RS1/C3MT33	***	45	100	39,7		* QJ 210 MA	160,89	50	90	20	5
* 3309 A-2RS1/MT33	***	45	100	39,7		* QJ 211 MA	***	55	100	21	5
* 3309 ATN9	194,61	45	100	39,7		* QJ 212 MA	255,20	60	110	22	5
** 3309 ATN9/C3	***	45	100	39,7		* QJ 213 MA	***	65	120	23	
* 3310 A	277,24	50	110	44,4		* QJ 214 N2MA	***	70	125	24	
** 3310 A/C3	282,49	50	110	44,4		* QJ 214 N2PHAS/C2L	***	70	125	24	
* 3310 A-2RS1/C3MT33	***	50	110	44,4		* QJ 215 MA	380,04	75	130	25	
* 3310 ATN9	***	50	110	44,4		* QJ 216 MA	446,56	80	140	26	
** 3310 ATN9/C3	***	50	110	44,4		* QJ 217 MA	***	85	150	28	
* 3311 A	300,28	55	120	49,2		* QJ 218 N2MA	***	90	160	30	
** 3311 A/C3	319,52	55	120	49,2		* QJ 219 N2MA	***	95	170	32	
* 3311 A-2RS1/C3MT33	***	55	120	49,2		* QJ 220 N2MA	***	100	180	34	
** 3311 ATN9/C3	***	55	120	49,2		* QJ 222 N2MA	***	110	200	38	
* 3312 A	367,36	60	130	54		* QJ 224 N2MA	***	120	215	40	
** 3312 A/C3	390,89	60	130	54		* QJ 226 N2MA	***	130	230	40	
* 3313 A	468,70	65	140	58,7		* QJ 228 N2MA	***	140	250	42	
** 3313 A/C3	477,55	65	140	58,7		* QJ 230 N2MA	***	150	270	45	
* 3314 A	556,59	70	150	63,5		* QJ 232 N2MA	***	160	290	48	
** 3314 A/C3	573,07	70	150	63,5		* QJ 234 N2MA	***	170	310	52	
* 3315 A	719,22	75	160	68,3							
** 3315 A/C3	732,79	75	160	68,3							
* 3316 A	812,24	80	170	68,3							
* 3316 A/C3	836,25	80	170	68,3							
* 3317 A	998,60	85	180	73							
* 3317 A/C3	***	85	180	73							
* 3318 A	1303,88	90	190	73							
* 3318 A/C3	1367,77	90	190	73							
* 3319 A	***	95	200	77,8							
* 3319 A/C3	***	95	200	77,8							
3320 A	***	100	215	82,6							
3320 A/C3	***	100	215	82,6							
3322 A	***	110	240	92,1							
3322 A/C3	***	110	240	92,1							

* = Explorer ** = Explorer recommended range

Ένσφαιρα ρουλεμάν γωνιακής επαφής
Viistokuulalaakerit
Rolamentos de esferas de contato angular
Vinkelkontaktkuglelejer
Vinkelkontaktkullager
Vinkelkontaktkulelager

Angular contact ball bearings
Schrägkugellager
Roulements à billes à contact oblique
Cuscinetti obliqui a sfera
Rodamientos de bolas con contacto angular
Hoekcontactkogellagers

	€	d	D	B	min		€	d	D	B	min
* QJ 304 MA	124,69	20	52	15	10						
* QJ 306 MA	131,99	30	72	19	5						
* QJ 307 MA	154,45	35	80	21	5						
* QJ 308 MA	178,95	40	90	23	5						
* QJ 309 MA	215,67	45	100	25	5						
* QJ 310 MA	278,79	50	110	27	5						
* QJ 311 MA	339,79	55	120	29							
* QJ 312 MA	412,64	60	130	31							
* QJ 313 MA	470,91	65	140	33							
* QJ 314 MA	570,04	70	150	35							
* QJ 315 N2MA	649,82	75	160	37							
* QJ 316 N2MA	758,67	80	170	39							
* QJ 317 N2MA	***	85	180	41							
* QJ 318 N2MA	***	90	190	43							
* QJ 319 N2MA	***	95	200	45							
* QJ 320 N2MA	1449,34	100	215	47							
* QJ 322 N2MA	***	110	240	50							
* QJ 324 N2MA	***	120	260	55							
* QJ 326 N2MA	***	130	280	58							
* QJ 328 N2MA	***	140	300	62							
* QJ 330 N2MA	***	150	320	65							

* = Explorer ** = Explorer recommended range

Κωνικά ρουλεμάν
 Kartiorullalaakerit
 Rolamentos de rolos cónicos
 Koniske rullelejer
 Koniska rullager
 Koniske rullelager

Taper roller bearings
 Kegeltrollenlager
 Roulements à rouleaux coniques
 Cuscinetti a rulli conici
 Rodamientos de rodillos cónicos
 Kegellagers

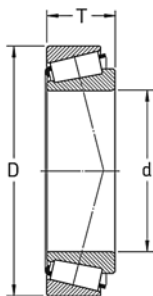

302	46
303	46
313	46
320	47
322	47
323	47
329	47
330	48
331	48
332	48

Taper roller bearings
Kegelrollenlager
Roulements à rouleaux coniques
Cuscinetti a rulli conici
Rodamientos de rodillos cónicos
Kegelaggers

Κωνικά ρουλεμάν
Kartiorullalaakerit
Rolamentos de rolos cónicos
Koniske rullelejer
Koniska rullager
Koniske rullelager

	€	d	D	T	min		€	d	D	T	min
30203 J2	25,17	17	40	13,3	10	30316 J2	371,27	80	170	42,7	
30204 J2/Q	26,78	20	47	15,3	10	30317 J2	***	85	180	44,8	
30205 J2/Q	29,67	25	52	16,3	10	30318 J2	555,08	90	190	47,3	
30206 J2/Q	32,61	30	62	17,3	5	30319	***	95	200	50,9	
30305 J2/Q	37,42	25	62	18,3	5	30320 J2	872,56	100	215	51,7	
30207 J2/Q	40,65	35	72	18,8	5	30322 J2	1427,47	110	240	55,9	
30208 J2/Q	48,86	40	80	20,4	5	30324 J2	***	120	260	60,1	
30209 J2/Q	54,39	45	85	21	5						
30210 J2/Q	69,09	50	90	22,1	5						
* 30211 J2/Q	76,66	55	100	23,6	5						
* 30212 J2/Q	91,44	60	110	24,3	5	31305 J2	60,20	25	62	18,4	5
* 30213 J2/Q	112,75	65	120	26		31306 J2/Q	70,84	30	72	21,1	5
30214 J2/Q	124,66	70	125	26,3		31307 J2/Q	80,83	35	80	23,3	5
30215 J2/Q	131,50	75	130	28,1		* 31308 J2/QCL7C	97,11	40	90	25,5	5
30216 J2/Q	156,30	80	140	29,3		* 31309 J2/QCL7C	126,21	45	100	27,7	5
30217 J2/Q	189,13	85	150	31,4		* 31310 J2/QCL7C	144,50	50	110	29,9	5
30218 J2	230,51	90	160	33,6		31311 J2/Q	175,09	55	120	31,5	
30219 J2	281,27	95	170	35,5		31312 J2/Q	215,09	60	130	34,4	
30220 J2	342,03	100	180	37,7		31313 J2/QCL7C	299,57	65	140	36,7	
30221 J2	***	105	190	39,9		31314 J2/QCL7A	322,28	70	150	38,7	
30222 J2	495,06	110	200	42,1		31315 J2	***	75	160	40,6	
30224 J2	640,57	120	215	44,6		31316 J1/QCL7A	503,43	80	170	42,5	
30226 J2	858,08	130	230	45		31317 J2	***	85	180	44,5	
30228 J2	1177,60	140	250	47,9		31318 J2	855,23	90	190	46,5	
30230	1575,54	150	270	52,2		31319 J2	***	95	200	49,5	
30232 J2	***	160	290	52,7		31320 XJ2	1814,04	100	215	57,3	
30302 J2	31,51	15	42	14,3	10						
30302 J2/VE197	52,05	15	42	14,3	10						
30303 J2	31,08	17	47	15,5	10						
30303 J2/VE197	71,17	17	47	15,5	10						
30304 J2/Q	30,82	20	52	16,5	5						
30306 J2/Q	46,22	30	72	20,9	5						
30307 J2/Q	55,05	35	80	23,1	5						
30308 J2/Q	67,72	40	90	25,3	5						
30309 J2/Q	86,17	45	100	27,3	5						
* 30310 J2/Q	104,44	50	110	29,3	5						
* 30311 J2/Q	137,88	55	120	31,5							
30312 J2/Q	164,43	60	130	34,1							
30313 J2/Q	206,28	65	140	36,3							
30314 J2/Q	256,54	70	150	38,8							
30315 J2	312,80	75	160	40,5							

* = Explorer

Κωνικά ρουλεμάν
Kartiorullalaakerit
Rolamentos de rolos cónicos
Koniske rullelejer
Koniska rullager
Koniske rullelager

Taper roller bearings
Kegelrollenlager
Roulements à rouleaux coniques
Cuscinetti a rulli conici
Rodamientos de rodillos cónicos
Kegelrollers

	€	d	D	T	min		€	d	D	T	min
32004 X/Q	30,86	20	42	15,8	10	32215 J2/Q	155,19	75	130	33,5	
32005 X/Q	30,61	25	47	15,9	10	32216 J2/Q	176,10	80	140	36,1	
* 320/28 X/Q	41,57	28	52	16,8	10	32217 J2/Q	212,22	85	150	38,6	
32006 X/Q	35,09	30	55	18,2	5	32218 J2/Q	278,40	90	160	42,7	
320/32 X/Q	48,38	32	58	18,2	5	32219 J2	350,62	95	170	45,5	
32007 J2/Q	42,61	35	62	18	5	32220 J2	416,50	100	180	49	
* 32007 X/Q	37,72	35	62	19,3	5	32221 J2	***	105	190	53	
32008 X/Q	43,37	40	68	20,3	5	32222 J2	680,15	110	200	56	
32009 X/Q	49,73	45	75	21,2	5	32224 J2	1183,62	120	215	61,5	
32010 X/Q	59,25	50	80	21,6	5	32226 J2	1530,32	130	230	67,8	
32011 X/Q	70,04	55	90	24,5	5	32228 J2	1904,63	140	250	71,8	
* 32012 X/QCL7C	85,24	60	95	24,6	5	32230 J2	2480,63	150	270	77	
* 32013 X/Q	99,85	65	100	24,6	5	32232 J2	***	160	290	84,5	
32014 X/Q	114,06	70	110	26,7	5	32234 J2	***	170	310	91	
32015 X/Q	124,44	75	115	26,7							
32016 X/Q	148,88	80	125	31,2		32303 J2	46,74	17	47	20,3	5
32017 X/Q	167,39	85	130	31,2		32304 J2/Q	48,13	20	52	22,3	5
32018 X/Q	191,67	90	140	33,9		32305 J2	52,04	25	62	25,7	5
32019 X/Q	209,61	95	145	34,3		32306 J2/Q	65,56	30	72	28,8	5
32020 X/Q	211,84	100	150	34,3		32307 J2/Q	75,90	35	80	32,8	5
32021 X/Q	283,52	105	160	37,1		32308 J2/Q	92,15	40	90	35,3	5
32022 X/Q	309,03	110	170	40,3		32309 J2/Q	110,72	45	100	38,3	
32024 X	379,62	120	180	40,3		32310 J2/Q	138,03	50	110	42,3	
32026 X	571,43	130	200	47,4		32311 J2	175,81	55	120	45,5	
32028 X	749,98	140	210	47,5		32312 J2/Q	214,23	60	130	48,8	
32030 X	976,69	150	225	50,4		32313 J2/Q	285,67	65	140	51	
32032 X	1170,47	160	240	53,6		32314 J2/Q	336,58	70	150	54,2	
32034 X	1568,51	170	260	60		32315 J2	422,03	75	160	58,3	
32036 X	1956,06	180	280	67		32316 J2	506,17	80	170	61,5	
32038 X	2384,34	190	290	67		32317 J2	683,95	85	180	63,5	
32040 X	2819,94	200	310	73,1		32318 J2	852,78	90	190	67,5	
32044 X	***	220	340	80,1		32319 J2	***	95	200	71,5	
						32320 J2	1572,47	100	215	77,5	
						32321 J2	***	105	225	81,5	
						32322	2216,06	110	240	84,6	
32205 BJ2/Q	59,09	25	52	19,3	5	32324 J2	2927,17	120	260	90,5	
32206 J2/Q	41,33	30	62	21,3	5	32924	***	120	165	30,9	
32207 J2/Q	48,22	35	72	24,3	5	32926	570,41	130	180	34,2	
32208 J2/Q	54,12	40	80	24,8	5	32928	***	140	190	34,2	
* 32209 J2/Q	60,64	45	85	24,8	5	32934	***	170	230	41,1	
32210 J2/Q	67,97	50	90	25,9	5	32936	1249,72	180	250	47,9	
32211 J2/Q	92,29	55	100	27,1		32938	1473,91	190	260	47,9	
32212 J2/Q	110,18	60	110	31,2	5	32940	***	200	280	54,2	
32213 J2/Q	137,88	65	120	33,4							
32214 J2/Q	144,78	70	125	33,4							

* = Explorer



Taper roller bearings
Kegelrollenlager
Roulements à rouleaux coniques
Cuscinetti a rulli conici
Rodamientos de rodillos cónicos
Kegellagers

Κωνικά ρουλεμάν
Kartiorullalaakerit
Rolamentos de rolos cónicos
Koniske rullelejer
Koniska rulllager
Koniske rullelager

	€	d	D	T	min		€	d	D	T	min
33010/Q	95,75	50	80	24,8	5						
* 33011/Q	***	55	90	28,5	5						
* 33012/Q	136,28	60	95	28,6	5						
* 33013/Q	124,02	65	100	28,6	5						
33014	142,52	70	110	32,2	5						
33015/Q	156,07	75	115	33							
33016/Q	183,87	80	125	37,6							
33017/Q	204,24	85	130	37,9							
33018/Q	249,44	90	140	41,3							
33019/Q	257,16	95	145	41,3							
33020/Q	268,02	100	150	41,3							
33021/Q	318,92	105	160	45,3							
33022	388,12	110	170	48,7							
33024	506,16	120	180	48,8							
33108/Q	83,52	40	75	27,2	5						
* 33109/Q	87,17	45	80	27,3	5						
33110/Q	98,40	50	85	27,3	5						
33111/Q	114,29	55	95	31,4	5						
33112/Q	134,45	60	100	31,5	5						
33113/Q	152,68	65	110	35,8							
33114/Q	***	70	120	38,5							
33115/Q	199,48	75	125	39							
33116/Q	214,85	80	130	39							
33117/Q	***	85	140	43							
33118/Q	308,72	90	150	47,2							
33122	***	110	180	58,4							
* 33205/Q	48,29	25	52	23,1	5						
33206/Q	61,19	30	62	26,5	5						
33207/Q	73,00	35	72	29,4	5						
33208/Q	87,29	40	80	33,5	5						
33209/Q	99,04	45	85	33,5	5						
33210/Q	105,85	50	90	33,5	5						
33211/Q	128,37	55	100	37							
33212/Q	166,25	60	110	39,7							
33213/Q	189,99	65	120	42,8							
33214/Q	***	70	125	42,8							
33215/Q	240,87	75	130	42,8							
33216/Q	308,72	80	140	48,2							
33217/Q	372,34	85	150	51							
33220	953,36	100	180	65,7							

* = Explorer

Κωνικά ρουλεμάν σε ίντσες
Tuumamittaiset kartiorullalaakerit
Rolamentos de rolos cónicos em polegadas

Koniske rullelejer i tommemål
Koniska rullager med tumdimensioner
Koniske rullelager i tommemål

Inch-size taper roller bearings
Kegelrollenlager mit Zollabmessungen
Roulements à rouleaux coniques à cotes en
pouces
Cuscinetti a rulli conici in pollici
Rodamientos de rodillos cónicos en pulgadas
Kegellagers in inch maten

ISTRB 50

Inch-size taper roller bearings
Kegelrollenlager mit Zollabmessungen
Roulements à rouleaux coniques à cotes en pouces
Cuscinetti a rulli conici in pollici
Rodamientos de rodillos cónicos en pulgadas
Kegellagers in inch maten

Κωνικά ρουλεμάν σε ίντσες
Tuumamittaiset kartiorullalaakerit
Rolamentos de rolos cónicos em polegadas
Koniske rullelejer i tommemål
Koniska rullager med tumdimensioner
Koniske rullelager i tommemål

	€		€
T7FC 055/QCL7C	215,97	33287/33462/Q	***
359 S/354 X/Q	84,29	39580/W/2/39520/2/Q	***
368 A/362 A/Q	125,33	39581/39520/Q	133,17
387 A/382 A/Q	79,47	39590/39520/Q	122,57
399 A/394 A/QVB079	93,56	L 44649/610/Q	28,49
418/414/Q	127,99	L 45449/410/Q	21,84
482/472/Q	224,29	47487/47420 A/Q	252,89
537/532 X/Q	195,41	LM 48548/510/Q	37,01
575/572/Q	206,03	LM 67048/010/Q	29,3
580/572/Q	176,01	LM 67048/010	30,29
593/592 A/Q	221,02	L 68149/110/Q	36,66
594/592 A/Q	219,57	L 68149/111/Q	32,66
1380/1328/Q	81,1	JL 69349 A/310/Q	37,69
1982 F/1924 A/QVQ519	30,78	JL 69349 X/310/Q	42,83
1988/1922/Q	36,4	JL 69349/310/Q	37,66
02872/2/02820/2/Q	32,89	M 84548/2/510/2/QVQ506	44,28
3585/3525/Q	112,49	M 86649/2/610/2/QVQ506	45,89
3780/3720/Q	150,53	M 88048/2/010/2/QCL7C	46,52
3982/3920/2/Q	79,14	HM 88542/2/510/2/QCL7C	67,32
3984/2/3920/2/Q	54,48	HM 88649/2/610/2/QCL7C	54,94
6379/K-6320/Q	366,44	HM 89449/2/410/2/QCL7C	90,08
6386/K-6320/Q	360,7	LM 102949/910/Q	43,3
09067/09195/Q	43,8	JLM 104948 AA/910 AA/Q	66,9
11590/11520	61,52	JM 205149/110/Q	115,59
LM 11749/710/QVC027	21,12	HM 212010	***
LM 11749/710/Q	21,12	HM 218248/W/2A/210/2A/Q	216,44
LM 11949/910/Q	23,12	HM 220149/110/Q	274,15
M 12649/610/Q	35,45	LM 300849/811/Q	42,35
LM 12749/710/Q	31,98	BT1B 329013 A/Q	***
LM 12749/711/Q	31,97	330356 A/Q	***
15101/15245	48,36	330632 C/Q	***
15123/15245/Q	43,27	330757 C/QCL7CVA606	40,05
18590/18520/Q	78,55	330865 C/QCL7C	***
18690/18620/Q	67,88	331075/Q	***
18790/18720/Q	65,27	331126/Q	***
24780/24720/Q	85,73	331293/Q	***
25590/2/25523/2/Q	68,46	331305 A/Q	***
25877/2/25821/2/Q	49,23	331474/Q	***
LM 29748/710	63,15	331589/Q	***
LM 29749 F/711/Q	59,73	331761 B/Q	***
LM 29749/710/Q	38,19	331933/Q	***
LM 29749/710	40,14	331958/Q	***
LM 29749/710/QCL7CVA607	38,19	331964/Q	***
LM 29749/711/Q	67,61	331974 A/Q	221,64
31594/2/31520/2	38,27	332330 B/Q	***

Κωνικά ρουλεμάν σε ίντσες

Tuumamittaiset kartiorullalaakerit

Rolamentos de rolos cónicos em polegadas

Koniske rullelejer i tommemål

Koniska rullager med tumdimensioner

Koniske rullelager i tommemål

Inch-size taper roller bearings

Kegelrollenlager mit Zollabmessungen

Roulements à rouleaux coniques à cotes en pouces

Cuscinetti a rulli conici in pollici

Rodamientos de rodillos cónicos en pulgadas

Kegellagers in inch maten

	€		€
361206 R	***		
440809 A/Q	***		
442882/Q	***		
LM 501349/310	45,78		
LM 501349/310/Q	45,78		
LM 501349/314/Q	48,53		
LM 503349 A/310/QCL7C	47,35		
LM 503349/310/QCL7C	48,58		
JM 515649/610/Q	253,54		
LM 603049/011	52,86		
LM 603049/011/Q	51,46		
639330/Q	***		
639337 A/QCL7C	***		
639338 A/QCL7C	***		
BT1B 639405/Q	***		
JM 714249/210/Q	210,88		
JM 718149 A/110/Q	233,3		
HM 801346 X/310/QCL7A	98,28		
HM 801346/310/Q	150,32		
M 802048/011/QCL7C	74,35		
HM 803146/2/110/2/QCL7C	99,73		
HM 803149/2/110/2/QCL7C	106,92		
LM 806649/610/Q	63,09		
HM 903249/2/210/2/Q	43,89		
H 913842/810/QCL7C	426,07		

Κυλινδρική ρουλεμάν
 Lieriõrullalaakerit
 Rolamentos de rolos cilíndricos
 Cylindriska rullelejer
 Cylindriska rullager
 Sýlindriska rullelager

Cylindrical roller bearings
 Zylinderrollenlager
 Roulements à rouleaux cylindriques
 Cuscinetti a rulli cilindrici
 Rodamientos de rodillos cilíndricos
 Cylindrlager

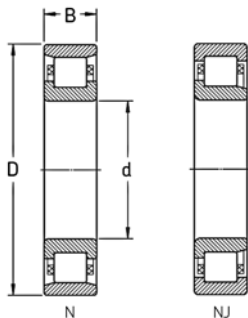

N 2	55
N 3	55
NJ 2	55
NJ 3	56
NJ 4	56
NJ 20	56
NJ 22	56
NJ 23	56

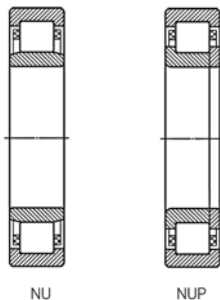

NU 2	57
NU 3	58
NU 4	59
NU 10	59
NU 22	60
NU 23	60
NUP 2	61
NUP 3	61
NUP 22	61
NUP 23	61

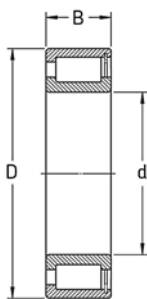

NCF 29	62
NCF 30	62

Cylindrical roller bearings
Zylinderrollenlager
Roulements à rouleaux cylindriques
Cuscinetti a rulli cilindrici
Rodamientos de rodillos cilíndricos
Cylinderlagers

Κυλινδρική ρουλεμάν
Lieriõrullalaakerit
Rolamentos de rolos cilíndricos
Cylindriska rullelejer
Cylindriska rullager
Sylindriske rullelager

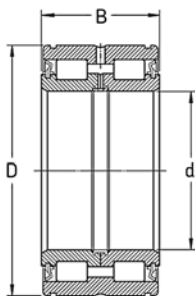

NNF 50 62

Κυλινδρικά ρουλεμάν
Lieriörollaakaerit
Rolamentos de rolos cilíndricos
Cylindriska rullelejer
Cylindriska rullager
Sylindriska rullelager

Cylindrical roller bearings
Zylinderrollenlager
Roulements à rouleaux cylindriques
Cuscinetti a rulli cilindrici
Rodamientos de rodillos cilíndricos
Cylinderlagers

	€	d	D	B	min		€	d	D	B	min
N 203 ECP	***	17	40	12	10	NJ 202 ECP	50,48	15	35	11	10
N 204 ECP	***	20	47	14	10	NJ 203 ECP	52,07	17	40	12	10
N 205 ECP	***	25	52	15	10	NJ 204 ECP	55,25	20	47	14	10
N 206 ECP	***	30	62	16	5	NJ 205 ECP	59,18	25	52	15	10
* N 207 ECP	***	35	72	17	5	NJ 205 ECP/C3	***	25	52	15	10
* N 208 ECP	***	40	80	18	5	* NJ 206 ECJ	***	30	62	16	5
* N 209 ECP	***	45	85	19	5	* NJ 206 ECP	68,30	30	62	16	5
* N 210 ECP	***	50	90	20	5	* NJ 206 ECP/C3	***	30	62	16	5
* N 213 ECP	308,15	65	120	23		* NJ 207 ECJ	***	35	72	17	5
* N 215 ECP	378,08	75	130	25		* NJ 207 ECP	79,63	35	72	17	5
* N 215 ECP/C3	378,08	75	130	25		* NJ 207 ECP/C3	***	35	72	17	5
* N 216 ECP	403,85	80	140	26		* NJ 208 ECJ	108,87	40	80	18	5
* N 217 ECP	***	85	150	28		* NJ 208 ECP	92,15	40	80	18	5
* N 217 ECP/C3	465,91	85	150	28		* NJ 209 ECP	101,60	45	85	19	5
* N 218 ECP	***	90	160	30		* NJ 210 ECJ	***	50	90	20	5
* N 219 ECP	***	95	170	32		* NJ 210 ECP	108,64	50	90	20	5
* N 220 ECP	***	100	180	34		* NJ 211 ECJ	139,17	55	100	21	5
* N 222 ECP	***	110	200	38		* NJ 211 ECP	127,06	55	100	21	5
* N 224 ECP	***	120	215	40		* NJ 309 ECP/C3	***	45	100	25	5
* N 226 ECP	***	130	230	40		* NJ 212 ECJ	168,26	60	110	22	5
* N 305 ECP	***	25	62	17	5	* NJ 212 ECP	153,35	60	110	22	5
* N 306 ECP	117,24	30	72	19	5	* NJ 213 ECP	178,47	65	120	23	
* N 307 ECP	115,04	35	80	21	5	* NJ 214 ECJ	214,45	70	125	24	
* N 308 ECP	***	40	90	23	5	* NJ 214 ECP	194,76	70	125	24	
* N 309 ECP	***	45	100	25	5	* NJ 215 ECP	***	75	130	25	
* N 310 ECP	***	50	110	27	5	* NJ 216 ECJ	294,50	80	140	26	
* N 311 ECP	***	55	120	29		* NJ 216 ECP	249,68	80	140	26	
* N 312 ECP	***	60	130	31		* NJ 217 ECM	***	85	150	28	
* N 313 ECP	***	65	140	33		* NJ 217 ECP	288,41	85	150	28	
* N 314 ECM	917,48	70	150	35		* NJ 218 ECP	337,91	90	160	30	
* N 314 ECP	388,10	70	150	35		* NJ 219 ECP	415,95	95	170	32	
* N 315 ECP	533,57	75	160	37		* NJ 220 ECJ	508,22	100	180	34	
* N 316 ECP	***	80	170	39		* NJ 220 ECP	460,72	100	180	34	
* N 317 ECP	586,23	85	180	41		* NJ 221 ECP	***	105	190	36	
* N 318 ECP	***	90	190	43		* NJ 222 ECJ	710,50	110	200	38	
* N 318 ECP/C3	740,12	90	190	43		* NJ 222 ECP	***	110	200	38	
* N 319 ECP	***	95	200	45		* NJ 224 ECJ	817,38	120	215	40	
* N 320 ECP	1025,54	100	215	47		* NJ 224 ECP	***	120	215	40	
* N 321 ECP	***	105	225	49		* NJ 226 ECJ	1026,86	130	230	40	
* N 322 ECP	1347,59	110	240	50		* NJ 226 ECP	927,94	130	230	40	
* N 324 ECP	***	120	260	55		* NJ 228 ECJ	1295,92	140	250	42	
						* NJ 230 ECJ	1623,15	150	270	45	
						* NJ 232 ECML	***	160	290	48	
						* NJ 234 ECMA	***	170	310	52	
						* NJ 236 ECMA	***	180	320	52	

* = Explorer



Cylindrical roller bearings
Zylinderrollenlager
Roulements à rouleaux cylindriques
Cuscinetti a rulli cilindrici
Rodamientos de rodillos cilíndricos
Cilindertagers

Κυλινδρικά ρουλεμάν
Lieriörollaakaerit
Rolamentos de rolos cilíndricos
Cylindriske rullelejer
Cylindriska rullager
Sylindriske rullelager

	€	d	D	B	min		€	d	D	B	min
NJ 303 ECP	83,87	17	47	14	10	NJ 2004 EV/C3	152,17	20	42	14	10
* NJ 304 ECP	62,63	20	52	15	10						
* NJ 305 ECP	70,74	25	62	17	5						
* NJ 305 ECP/C3	***	25	62	17	5						
* NJ 306 ECP	88,69	30	72	19	5						
* NJ 306 ECP/C3	88,69	30	72	19	5	NJ 2203 ECP	140,28	17	40	16	10
* NJ 307 ECJ	118,19	35	80	21	5	NJ 2204 ECP	65,87	20	47	18	10
* NJ 307 ECP	98,11	35	80	21	5	NJ 2205 ECP	72,05	25	52	18	10
* NJ 308 ECJ	***	40	90	23	5	* NJ 2206 ECP	84,15	30	62	20	5
* NJ 308 ECP	118,02	40	90	23	5	* NJ 2206 ECP/C3	***	30	62	20	5
* NJ 308 ECP/C3	***	40	90	23	5	* NJ 2207 ECP	94,96	35	72	23	5
* NJ 309 ECJ	***	45	100	25	5	* NJ 2208 ECJ	134,87	40	80	23	5
* NJ 309 ECP	138,52	45	100	25	5	* NJ 2208 ECP	114,36	40	80	23	5
* NJ 310 ECJ	183,20	50	110	27	5	* NJ 2208 ECP/C3	***	40	80	23	5
* NJ 310 ECP	166,92	50	110	27	5	* NJ 2209 ECP	125,18	45	85	23	5
* NJ 310 ECP/C3	***	50	110	27	5	* NJ 2210 ECJ	***	50	90	23	5
* NJ 311 ECJ	***	55	120	29		* NJ 2210 ECP	135,14	50	90	23	5
* NJ 311 ECP	199,48	55	120	29		* NJ 2211 ECP	160,49	55	100	25	5
* NJ 312 ECJ	***	60	130	31		* NJ 2212 ECJ	***	60	110	28	5
* NJ 312 ECP	234,08	60	130	31		* NJ 2212 ECP	192,02	60	110	28	5
* NJ 313 ECJ	***	65	140	33		* NJ 2213 ECP	219,14	65	120	31	
* NJ 313 ECP	282,26	65	140	33		* NJ 2214 ECP	240,20	70	125	31	
* NJ 314 ECJ	394,16	70	150	35		* NJ 2215 ECJ	***	75	130	31	
* NJ 314 ECP	333,88	70	150	35		* NJ 2215 ECP	***	75	130	31	
* NJ 315 ECJ	***	75	160	37		* NJ 2216 ECJ	***	80	140	33	
* NJ 315 ECP	387,45	75	160	37		* NJ 2216 ECP	312,13	80	140	33	
* NJ 316 ECP	451,92	80	170	39		* NJ 2217 ECP	***	85	150	36	
* NJ 317 ECP	***	85	180	41		* NJ 2218 ECP	440,37	90	160	40	
* NJ 318 ECJ	***	90	190	43		* NJ 2219 ECP	***	95	170	43	
* NJ 319 ECJ	***	95	200	45		* NJ 2220 ECP	626,93	100	180	46	
* NJ 319 ECP	***	95	200	45		* NJ 2222 ECP	***	110	200	53	
* NJ 320 ECJ	***	100	215	47		* NJ 2224 ECJ	***	120	215	58	
* NJ 321 ECJ	***	105	225	49							
* NJ 322 ECJ	1429,74	110	240	50							
* NJ 324 ECJ	***	120	260	55							
NJ 406 MA/C3P	312,76	30	90	23	5	* NJ 2304 ECP	84,41	20	52	21	10
NJ 408	***	40	110	27	5	* NJ 2305 ECP	92,15	25	62	24	5
NJ 408 MA/C3	***	40	110	27	5	* NJ 2306 ECML/C3	223,65	30	72	27	5
NJ 409	***	45	120	29		* NJ 2306 ECP	112,65	30	72	27	5
NJ 409 MAS/C3	571,08	45	120	29		* NJ 2306 ECP/C3	***	30	72	27	5
NJ 410	***	50	130	31		* NJ 2307 ECP	131,96	35	80	31	5
NJ 412	***	60	150	35		* NJ 2307 ECP/C3	141,43	35	80	31	5
NJ 413	***	65	160	37		* NJ 2308 ECJ	177,74	40	90	33	5
						* NJ 2308 ECML/C3	260,38	40	90	33	5
						* NJ 2308 ECP	161,11	40	90	33	5

* = Explorer

Κυλινδρικά ρουλεμάν
Lieriõrullalaakerit
Rolamentos de rolos cilíndricos
Cylindriska rullelejer
Cylindriska rullager
Sylindriska rullelager

Cylindrical roller bearings
Zylinderrollenlager
Roulements à rouleaux cylindriques
Cuscinetti a rulli cilindrici
Rodamientos de rodillos cilíndricos
Cylinderlagers

	€	d	D	B	min		€	d	D	B	min
* NJ 2308 ECP/C3	161,11	40	90	33	5	* NU 208 ECJ	***	40	80	18	5
* NJ 2309 ECML/C3	344,39	45	100	36	5	* NU 208 ECKP/C3	***	40	80	18	5
* NJ 2309 ECP	195,72	45	100	36	5	* NU 208 ECP	81,75	40	80	18	5
* NJ 2309 ECP/C3	195,72	45	100	36	5	* NU 208 ECP/C3	***	40	80	18	5
* NJ 2310 ECML/C3	470,22	50	110	40		* NU 209 ECJ	***	45	85	19	5
* NJ 2310 ECP	243,58	50	110	40		* NU 209 ECP	90,81	45	85	19	5
* NJ 2310 ECP/C3	243,58	50	110	40		* NU 210 ECJ	***	50	90	20	5
* NJ 2311 ECML/C3	517,00	55	120	43		* NU 210 ECP	98,29	50	90	20	5
* NJ 2311 ECP	288,41	55	120	43		* NU 210 ECP/C3	***	50	90	20	5
* NJ 2311 ECP/C3	288,41	55	120	43		* NU 211 ECJ	***	55	100	21	5
* NJ 2312 ECML	***	60	130	46		* NU 211 ECM	426,00	55	100	21	5
* NJ 2312 ECML/C3	***	60	130	46		* NU 211 ECP	118,25	55	100	21	5
* NJ 2312 ECP	348,78	60	130	46		* NU 211 ECP/C3	***	55	100	21	5
* NJ 2313 ECML/C3	682,78	65	140	48		* NU 212 ECJ	157,41	60	110	22	5
* NJ 2313 ECP	***	65	140	48		* NU 212 ECP	139,03	60	110	22	5
* NJ 2314 ECML/C3	864,88	70	150	51		* NU 212 ECP/C3	***	60	110	22	5
* NJ 2314 ECP	***	70	150	51		* NU 213 ECJ	187,29	65	120	23	
* NJ 2314 ECP/C3	502,10	70	150	51		* NU 213 ECP	164,78	65	120	23	
* NJ 2315 ECP	656,66	75	160	55		* NU 213 ECP/C3	169,64	65	120	23	
* NJ 2315 ECP/C3	***	75	160	55		* NU 214 ECJ	196,11	70	125	24	
* NJ 2316 ECP	***	80	170	58		* NU 214 ECP	177,79	70	125	24	
* NJ 2317 ECML/C3	1764,16	85	180	60		* NU 214 ECP/C3	***	70	125	24	
* NJ 2317 ECP	***	85	180	60		* NU 215 ECJ	***	75	130	25	
* NJ 2317 ECP/C3	823,71	85	180	60		* NU 215 ECP	195,42	75	130	25	
* NJ 2318 ECML/C3	***	90	190	64		* NU 215 ECP/C3	***	75	130	25	
* NJ 2318 ECP	***	90	190	64		* NU 216 ECJ	246,96	80	140	26	
* NJ 2319 ECJ	***	95	200	67		* NU 216 ECJ/C3	246,96	80	140	26	
* NJ 2319 ECML/C3	***	95	200	67		* NU 216 ECM	***	80	140	26	
* NJ 2320 ECJ	***	100	215	73		* NU 216 ECP	224,61	80	140	26	
* NJ 2320 ECML/C3	***	100	215	73		* NU 217 ECJ	288,41	85	150	28	
NU 202 ECP	47,24	15	35	11	10	* NU 217 ECM/C3	486,98	85	150	28	
NU 202 ECP/C3	***	15	35	11	10	* NU 217 ECP	261,93	85	150	28	
NU 203 ECP	48,05	17	40	12	10	* NU 217 ECP/C3	261,93	85	150	28	
NU 204 ECP	49,28	20	47	14	10	* NU 218 ECJ	***	90	160	30	
NU 204 ECP/C3	***	20	47	14	10	* NU 218 ECJ/C3	368,73	90	160	30	
NU 205 ECP	52,75	25	52	15	10	* NU 218 ECP	311,46	90	160	30	
NU 205 ECP/C3	***	25	52	15	10	* NU 219 ECJ	***	95	170	32	
* NU 206 ECJ	***	30	62	16	5	* NU 219 ECJ/C3	401,01	95	170	32	
* NU 206 ECP	61,80	30	62	16	5	* NU 219 ECM/C3	709,21	95	170	32	
* NU 206 ECP/C3	63,65	30	62	16	5	* NU 219 ECP	364,35	95	170	32	
* NU 207 ECJ	***	35	72	17	5	* NU 219 ECP/C3	364,35	95	170	32	
* NU 207 ECJ/C3	***	35	72	17	5	* NU 220 ECJ	468,21	100	180	34	
* NU 207 ECKP/C3	***	35	72	17	5	* NU 220 ECJ/C3	501,79	100	180	34	
* NU 207 ECP	72,57	35	72	17	5	* NU 220 ECML/C3	823,62	100	180	34	
* NU 207 ECP/C3	74,73	35	72	17	5	* NU 220 ECP	426,12	100	180	34	

* = Explorer



Cylindrical roller bearings
Zylinderrollenlager
Roulements à rouleaux cylindriques
Cuscinetti a rulli cilindrici
Rodamientos de rodillos cilíndricos
Cilinderlagers

Κυλινδρικά ρουλεμάν
Lieriörollaakaerit
Rolamentos de rolos cilíndricos
Cylindriske rullelejer
Cylindriska rullager
Sylindriske rullelager

	€	d	D	B	min		€	d	D	B	min
* NU 220 ECP/C3	***	100	180	34		* NU 307 ECJ	97,12	35	80	21	5
* NU 221 ECP	***	105	190	36		* NU 307 ECP	85,84	35	80	21	5
* NU 222 ECJ	593,73	110	200	38		* NU 307 ECP/C3	***	35	80	21	5
* NU 222 ECJ/C3	593,73	110	200	38		* NU 308 ECJ	112,55	40	90	23	5
* NU 222 ECM/C3	1159,81	110	200	38		* NU 308 ECJ/C3	115,88	40	90	23	5
* NU 222 ECP	539,43	110	200	38		* NU 308 ECP	102,01	40	90	23	5
* NU 222 ECP/C3	539,43	110	200	38		* NU 308 ECP/C3	105,02	40	90	23	5
* NU 224 ECJ	689,38	120	215	40		* NU 309 ECJ	143,37	45	100	25	5
* NU 224 ECJ/C3	689,38	120	215	40		* NU 309 ECJ/C3	143,37	45	100	25	5
* NU 224 ECM/C3	963,91	120	215	40		* NU 309 ECP	126,70	45	100	25	5
* NU 224 ECP	626,93	120	215	40		* NU 309 ECP/C3	130,43	45	100	25	5
* NU 226 ECJ	852,20	130	230	40		* NU 310 ECJ	171,11	50	110	27	5
* NU 226 ECJ/C3	852,20	130	230	40		* NU 310 ECJ/C3	171,11	50	110	27	5
* NU 226 ECM/C3	1409,41	130	230	40		* NU 310 ECM/C3	325,45	50	110	27	5
* NU 226 ECML	***	130	230	40		* NU 310 ECP	150,86	50	110	27	5
* NU 226 ECP	773,54	130	230	40		* NU 310 ECP/C3	150,86	50	110	27	5
* NU 2226 ECML/C3	***	130	230	64		* NU 311 ECJ	199,44	55	120	29	
* NU 228 ECJ	1126,34	140	250	42		* NU 311 ECJ/C3	***	55	120	29	
* NU 228 ECJ/C3	***	140	250	42		* NU 311 ECM/C3	***	55	120	29	
* NU 228 ECML	***	140	250	42		* NU 311 ECP	176,41	55	120	29	
* NU 228 ECML/C3	1767,52	140	250	42		* NU 311 ECP/C3	181,66	55	120	29	
NU 2324 ECML	***	120	260	86		* NU 312 ECJ	236,93	60	130	31	
NU 2324 ECML/C3	***	120	260	86		* NU 312 ECJ/C3	236,93	60	130	31	
* NU 230 ECJ	1404,57	150	270	45		* NU 312 ECM	***	60	130	31	
* NU 230 ECJ/C3	***	150	270	45		* NU 312 ECM/C3	354,45	60	130	31	
* NU 230 ECML/C3	1954,75	150	270	45		* NU 312 ECP	209,70	60	130	31	
* NU 2230 ECM/C3	***	150	270	73		* NU 312 ECP/C3	209,70	60	130	31	
* NU 2326 ECML	***	130	280	93		* NU 313 ECJ	276,42	65	140	33	
* NU 2326 ECML/C3	***	130	280	93		* NU 313 ECJ/C3	276,42	65	140	33	
* NU 232 ECML	2064,25	160	290	48		* NU 313 ECM	***	65	140	33	
* NU 232 ECML/C3	2064,25	160	290	48		* NU 313 ECM/C3	***	65	140	33	
* NU 234 ECMA	***	170	310	52		* NU 313 ECP	244,84	65	140	33	
* NU 234 ECMA/C3	***	170	310	52		* NU 313 ECP/C3	244,84	65	140	33	
* NU 236 ECMA	2837,10	180	320	52		* NU 314 ECJ	334,34	70	150	35	
* NU 236 ECMA/C3	***	180	320	52		* NU 314 ECJ/C3	334,34	70	150	35	
* NU 238 ECMA/C3	***	190	340	55		* NU 314 ECM	485,81	70	150	35	
						* NU 314 ECM/C3	485,81	70	150	35	
						* NU 314 ECP	295,34	70	150	35	
						* NU 314 ECP/C3	295,34	70	150	35	
						* NU 315 ECJ	438,18	75	160	37	
* NU 304 ECP	56,91	20	52	15	10	* NU 315 ECJ/C3	438,18	75	160	37	
* NU 305 ECP	65,27	25	62	17	5	* NU 315 ECM	***	75	160	37	
* NU 306 ECJ	83,06	30	72	19	5	* NU 315 ECM/C3	552,34	75	160	37	
* NU 306 ECP	73,63	30	72	19	5	* NU 315 ECP	338,80	75	160	37	
* NU 306 ECP/C3	75,80	30	72	19	5	* NU 315 ECP/C3	348,83	75	160	37	

* = Explorer

Κυλινδρικά ρουλεμάν
Lieriörollaakaerit
Rolamentos de rolos cilíndricos
Cylindriska rullelejer
Cylindriska rullager
Sylindriska rullelager

Cylindrical roller bearings
Zylinderrollenlager
Roulements à rouleaux cylindriques
Cusciniti a rulli cilindrici
Rodamientos de rodillos cilíndricos
Cylinderlagers

	€	d	D	B	min		€	d	D	B	min
* NU 316 ECJ	456,08	80	170	39		* NU 324 ECP/C3	***	120	260	55	
* NU 316 ECJ/C3	456,08	80	170	39		* NU 326 ECJ	***	130	280	58	
* NU 316 ECM	636,41	80	170	39		* NU 326 ECJ/C3	1841,10	130	280	58	
* NU 316 ECM/C3	636,41	80	170	39		* NU 326 ECM	***	130	280	58	
* NU 316 ECP	403,37	80	170	39		* NU 326 ECM/C3	2207,40	130	280	58	
* NU 316 ECP/C3	403,37	80	170	39		* NU 326 ECP	***	130	280	58	
* NU 317 ECJ	519,31	85	180	41		* NU 326 ECP/C3	***	130	280	58	
* NU 317 ECJ/C3	519,31	85	180	41		* NU 328 ECJ	***	140	300	62	
* NU 317 ECM	739,14	85	180	41		* NU 328 ECM	***	140	300	62	
* NU 317 ECM/C3	739,14	85	180	41		* NU 328 ECM/C3	2836,62	140	300	62	
* NU 317 ECP	459,65	85	180	41		* NU 330 ECM	***	150	320	65	
* NU 317 ECP/C3	473,20	85	180	41		* NU 330 ECM/C3	3498,38	150	320	65	
* NU 318 ECJ	591,05	90	190	43		* NU 332 ECMA	***	160	340	68	
* NU 318 ECJ/C3	591,05	90	190	43							
* NU 318 ECM	832,92	90	190	43							
* NU 318 ECM/C3	903,99	90	190	43		NU 406	***	30	90	23	5
* NU 318 ECP	536,42	90	190	43		NU 406 MA/C3	346,71	30	90	23	5
* NU 318 ECP/C3	536,42	90	190	43		NU 407	309,30	35	100	25	5
* NU 319 ECJ	650,92	95	200	45		NU 408	446,55	40	110	27	5
* NU 319 ECJ/C3	650,92	95	200	45		NU 409	353,84	45	120	29	
* NU 319 ECM	***	95	200	45		NU 410	***	50	130	31	
* NU 319 ECM/C3	908,79	95	200	45		NU 411	435,81	55	140	33	
* NU 319 ECP	591,05	95	200	45		NU 412	***	60	150	35	
* NU 319 ECP/C3	591,05	95	200	45		NU 413	765,74	65	160	37	
* NU 320 ECJ	839,84	100	215	47							
* NU 320 ECJ/C3	839,84	100	215	47		NU 1005	***	25	47	12	10
* NU 320 ECM	1150,11	100	215	47		NU 1006	80,24	30	55	13	5
* NU 320 ECM/C3	1150,11	100	215	47		NU 1007 ECP	97,53	35	62	14	5
* NU 320 ECML/C3	***	100	215	47		NU 1008 ML	181,61	40	68	15	5
* NU 320 ECP	738,98	100	215	47		NU 1009 ECP	136,95	45	75	16	5
* NU 320 ECP/C3	760,84	100	215	47		NU 1010 ML	206,25	50	80	16	5
* NU 321 ECJ	***	105	225	49		NU 1011 ECP	180,20	55	90	18	5
* NU 321 ECJ/C3	949,10	105	225	49		NU 1012 ML	261,62	60	95	18	5
* NU 321 ECP	***	105	225	49		NU 1013 ML	338,36	65	100	18	5
* NU 322 ECJ	1097,81	110	240	50		NU 1014 ML	352,16	70	110	20	5
* NU 322 ECJ/C3	1097,81	110	240	50		NU 1015 ML	359,46	75	115	20	
* NU 322 ECM	1521,07	110	240	50		NU 1016	383,29	80	125	22	
* NU 322 ECM/C3	1477,40	110	240	50		NU 1017 ML	591,24	85	130	22	
* NU 322 ECP	997,77	110	240	50		NU 1018 ML	596,09	90	140	24	
* NU 322 ECP/C3	997,77	110	240	50		NU 1019 ML	992,83	95	145	24	
* NU 324 ECJ	1412,42	120	260	55		NU 1020 ML	502,94	100	150	24	
* NU 324 ECJ/C3	1412,42	120	260	55		NU 1020 ML/C3	502,94	100	150	24	
* NU 324 ECM	***	120	260	55		NU 1021 ML	791,57	105	160	26	
* NU 324 ECM/C3	2074,46	120	260	55		NU 1022 M/C3	***	110	170	28	
* NU 324 ECP	1282,07	120	260	55		NU 1022 ML	638,64	110	170	28	

* = Explorer



Cylindrical roller bearings
Zylinderrollenlager
Roulements à rouleaux cylindriques
Cuscinetti a rulli cilindrici
Rodamientos de rodillos cilíndricos
Cilindertagers

Κυλινδρικά ρουλεμάν
Lieriörollaakaerit
Rolamentos de rolos cilíndricos
Cylindriske rullelejer
Cylindriska rullager
Sylindriske rullelager

	€	d	D	B	min		€	d	D	B	min
NU 1024 ML	723,30	120	180	28		* NU 2216 ECJ	***	80	140	33	
NU 1026 ML	874,81	130	200	33		* NU 2216 ECP	288,41	80	140	33	
NU 1026 ML/C3	874,81	130	200	33		* NU 2217 ECJ	***	85	150	36	
NU 1028 M/C3	***	140	210	33		* NU 2217 ECJ/C3	***	85	150	36	
NU 1028 ML	1033,73	140	210	33		* NU 2217 ECP	340,63	85	150	36	
NU 1030 ML	1182,25	150	225	35		* NU 2217 ECP/C3	340,63	85	150	36	
NU 1032 ML	1442,18	160	240	38		* NU 2218 ECJ/C3	439,65	90	160	40	
NU 1032 ML/C3	1442,18	160	240	38		* NU 2218 ECP	398,98	90	160	40	
NU 1034 M/C3	1895,87	170	260	42		* NU 2219 ECP	472,28	95	170	43	
NU 1034 ML	***	170	260	42		* NU 2219 ECP/C3	***	95	170	43	
NU 1036 ML	***	180	280	46		* NU 2220 ECJ	908,12	100	180	46	
NU 1036 ML/C3	***	180	280	46		* NU 2220 ECML/C3	1066,38	100	180	46	
NU 1038 ML	***	190	290	46		* NU 2220 ECP	567,23	100	180	46	
NU 1040 ML	2685,33	200	310	51		* NU 2220 ECP/C3	***	100	180	46	
NU 1044 ML	***	220	340	56		* NU 2222 ECJ/C3	845,45	110	200	53	
NU 1044 ML/C3	***	220	340	56		* NU 2222 ECML/C3	***	110	200	53	
NU 1048 ML	***	240	360	56		* NU 2222 ECP	772,16	110	200	53	
NU 1048 ML/C3	***	240	360	56		* NUP 224 ECJ	***	120	215	40	
						* NU 2224 ECJ	1073,38	120	215	58	
						* NU 2224 ECML	***	120	215	58	
NU 2203 ECP	***	17	40	16	10	* NU 2224 ECP	***	120	215	58	
NUP 2203 ECP	***	17	40	16	10	* NU 2226 ECML	1801,25	130	230	64	
NU 2204 ECP	***	20	47	18	10	* NU 2226 ECP	***	130	230	64	
NU 2205 ECP	63,32	25	52	18	10	* NU 2228 ECML	2483,62	140	250	68	
* NU 2206 ECP	76,11	30	62	20	5	* NU 2228 ECML/C3	***	140	250	68	
* NU 2207 ECP	86,97	35	72	23	5	* NU 2230 ECM	***	150	270	73	
* NU 2208 ECP	101,47	40	80	23	5	NU 2232 ECMA	***	160	290	80	
* NU 2208 ECP/C3	***	40	80	23	5						
* NU 2209 ECP	113,30	45	85	23	5						
* NU 2210 ECP	123,53	50	90	23	5						
* NU 2210 ECP/C3	***	50	90	23	5	* NU 2304 ECP	***	20	52	21	10
* NU 2211 ECJ	172,00	55	100	25	5	* NU 2305 ECP	86,25	25	62	24	5
* NU 2211 ECP	145,81	55	100	25	5	* NU 2306 ECP	***	30	72	27	5
* NU 2211 ECP/C3	***	55	100	25	5	* NU 2307 ECP	122,99	35	80	31	5
* NU 2212 ECJ	192,69	60	110	28	5	* NU 2308 ECJ	163,08	40	90	33	5
* NU 2212 ECP	170,70	60	110	28	5	* NU 2308 ECP	148,08	40	90	33	5
* NU 2212 ECP/C3	175,77	60	110	28	5	* NU 2309 ECP	181,53	45	100	36	5
* NU 2213 ECJ	***	65	120	31		* NU 2309 ECP/C3	181,53	45	100	36	5
* NU 2213 ECP	201,54	65	120	31		* NU 2310 ECML	***	50	110	40	
* NU 2213 ECP/C3	***	65	120	31		* NU 2310 ECP	223,27	50	110	40	
* NU 2214 ECP	225,27	70	125	31		* NU 2311 ECML/C3	508,04	55	120	43	
* NU 2214 ECP/C3	***	70	125	31		* NU 2311 ECP	276,83	55	120	43	
* NU 2215 ECJ	***	75	130	31		* NU 2312 ECP	333,14	60	130	46	
* NU 2215 ECP	243,58	75	130	31		* NU 2313 ECML/C3	759,89	65	140	48	
* NU 2215 ECP/C3	243,58	75	130	31		* NU 2313 ECP	408,97	65	140	48	

* = Explorer

Κυλινδρικά ρουλεμάν
Lieriõrullalaakerit
Rolamentos de rolos cilíndricos
Cylindriske rullelejer
Cylindriska rullager
Sylindriske rullelager

Cylindrical roller bearings
Zylinderrollenlager
Roulements à rouleaux cylindriques
Cuscinetti a rulli cilindrici
Rodamientos de rodillos cilíndricos
Cylinderlagers

	€	d	D	B	min		€	d	D	B	min
* NU 2314 ECP	475,02	70	150	51		* NUP 309 ECJ	***	45	100	25	5
* NU 2315 ECP	586,97	75	160	55		* NUP 309 ECJ/C3	190,87	45	100	25	5
* NU 2316 ECML/C3	***	80	170	58		* NUP 309 ECP	161,76	45	100	25	5
* NU 2316 ECP	651,71	80	170	58		* NUP 310 ECJ	***	50	110	27	5
* NU 2317 ECP	770,59	85	180	60		* NUP 310 ECP	195,43	50	110	27	5
* NU 2318 ECJ	***	90	190	64		* NUP 311 ECP	224,66	55	120	29	
* NU 2318 ECJ/C3	***	90	190	64		* NUP 312 ECP	***	60	130	31	
* NU 2318 ECP	***	90	190	64		* NUP 313 ECP	315,05	65	140	33	
* NU 2319 ECJ	***	95	200	67		* NUP 314 ECP	382,53	70	150	35	
* NU 2319 ECJ/C3	1234,38	95	200	67		* NUP 315 ECP	***	75	160	37	
* NU 2320 ECJ	***	100	215	73		* NUP 316 ECP	***	80	170	39	
* NU 2320 ECP	***	100	215	73		* NUP 317 ECP	***	85	180	41	
* NU 2322 ECMA/C3	***	110	240	80		* NUP 320 ECJ	***	100	215	47	
NU 2322 ECML	***	110	240	80							
* NU 2322 ECP	***	110	240	80							
NUP 203 ECP	73,75	17	40	12	10	* NUP 2205 ECP	80,56	25	52	18	10
NUP 204 ECP	63,82	20	47	14	10	* NUP 2206 ECP	95,08	30	62	20	5
NUP 205 ECP	70,44	25	52	15	10	* NUP 2207 ECP	108,54	35	72	23	5
* NUP 206 ECP	79,46	30	62	16	5	* NUP 2208 ECP	133,10	40	80	23	5
* NUP 207 ECP	89,26	35	72	17	5	* NUP 2209 ECP	138,53	45	85	23	5
* NUP 208 ECP	100,99	40	80	18	5	* NUP 2210 ECP	***	50	90	23	5
* NUP 209 ECP	114,76	45	85	19	5	* NUP 2211 ECP	176,04	55	100	25	5
* NUP 210 ECP	126,09	50	90	20	5	* NUP 2212 ECP	211,43	60	110	28	5
* NUP 211 ECP	154,26	55	100	21	5	* NUP 2213 ECP	***	65	120	31	
* NUP 212 ECP	182,21	60	110	22	5	* NUP 2214 ECP	***	70	125	31	
* NUP 213 ECP	216,30	65	120	23		* NUP 2215 ECP	***	75	130	31	
* NUP 214 ECP	237,85	70	125	24		* NUP 2216 ECP	***	80	140	33	
* NUP 215 ECP	***	75	130	25		* NUP 2217 ECP	***	85	150	36	
* NUP 216 ECP	306,02	80	140	26		* NUP 2218 ECP	***	90	160	40	
* NUP 217 ECP	***	85	150	28		* NUP 2220 ECP	***	100	180	46	
* NUP 218 ECP	***	90	160	30		* NUP 2222 ECP	***	110	200	53	
* NUP 219 ECP	***	95	170	32							
* NUP 220 ECP	736,76	100	180	34							
* NUP 222 ECP	***	110	200	38							
* NUP 228 ECJ	***	140	250	42							
* NUP 230 ECJ	***	150	270	45		* NUP 2305 ECP	***	25	62	24	5
						* NUP 2306 ECP	***	30	72	27	5
						* NUP 2307 ECP	150,09	35	80	31	5
						* NUP 2308 ECP	184,96	40	90	33	5
						* NUP 2309 ECP	***	45	100	36	5
* NUP 304 ECP	***	20	52	15	10	* NUP 2310 ECP	278,88	50	110	40	
* NUP 305 ECP	84,47	25	62	17	5	* NUP 2311 ECP	***	55	120	43	
* NUP 306 ECP	98,11	30	72	19	5	* NUP 2312 ECP	***	60	130	46	
* NUP 307 ECP	113,68	35	80	21	5	* NUP 2314 ECP	***	70	150	51	
* NUP 308 ECP	134,72	40	90	23	5						

* = Explorer



Cylindrical roller bearings
Zylinderrollenlager
Roulements à rouleaux cylindriques
Cuscinetti a rulli cilindrici
Rodamientos de rodillos cilíndricos
Cilindertagers

Κυλινδρική ρουλεμάν
Lieriörollalaakerit
Rolamentos de rolos cilíndricos
Cylindriske rullelejer
Cylindriska rullager
Sylindriske rullelager

	€	d	D	B	min		€	d	D	B	min
NCF 2916 CV	***	80	110	19		NNF 5004 ADB-2LSV	***	20	42	30	10
NCF 2918 CV	***	90	125	22		NNF 5005 ADB-2LSV	242,28	25	47	30	10
NCF 2920 CV	***	100	140	24		NNF 5006 ADB-2LSV	***	30	55	34	5
NCF 2922 CV	***	110	150	24		NNF 5007 ADB-2LSV	339,94	35	62	36	5
NCF 2924 CV	***	120	165	27		NNF 5008 ADB-2LSV	302,85	40	68	38	
NCF 2926 CV	***	130	180	30		NNF 5009 ADB-2LSV	***	45	75	40	
NCF 2930 CV	***	150	210	36		NNF 5010 ADB-2LSV	349,40	50	80	40	
NCF 2932 CV	***	160	220	36		NNF 5011 ADB-2LSV	387,12	55	90	46	
NCF 2934 CV	***	170	230	36		NNF 5012 ADB-2LSV	602,46	60	95	46	
NCF 2936 CV	***	180	250	42		NNF 5013 ADB-2LSV	467,27	65	100	46	
NCF 2938 CV/C3	***	190	260	42		NNF 5014 ADB-2LSV	525,23	70	110	54	
NCF 2940 CV	***	200	280	48		NNF 5015 ADB-2LSV	619,08	75	115	54	
NCF 2944 CV	***	220	300	48		NNF 5016 ADB-2LSV	709,53	80	125	60	
						NNF 5017 ADB-2LSV	***	85	130	60	
						NNF 5018 ADA-2LSV	***	90	140	67	
NCF 3004 CV	***	20	42	16	10	NNF 5020 ADA-2LSV	***	100	150	67	
						NNF 5022 ADA-2LSV	1638,41	110	170	80	
						NNF 5024 ADA-2LSV	1325,10	120	180	80	
						NNF 5026 ADA-2LSV	***	130	200	95	
						NNF 5028 ADA-2LSV	***	140	210	95	
						NNF 5030 ADA-2LSV	***	150	225	100	
						NNF 5034 ADA-2LSV	***	170	260	122	

* = Explorer

Βαρελοειδή ρουλεμάν
 Pallomaiset rullalaakerit
 Rolamentos autocompensadores de rolos
 Sfæriske rullelejer
 Sfäriska rullager
 Sfæriske rullelager

Spherical roller bearings
 Pendelrollenlager
 Roulements à rotule sur rouleaux
 Cuscinetti orientabili a rulli
 Rodamientos de rodillos a rótula
 Tweerijige tonlagen

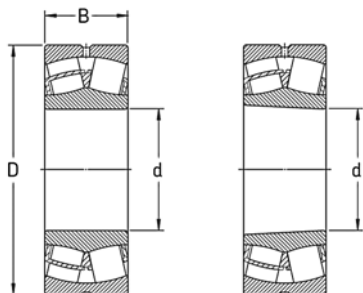

213	64
222	64
223	65
230	66
231	66
232	67
239	67
240	67
241	68



BS2-2CS	68
---------	-------	----

Spherical roller bearings
Pendelrollenlager
Roulements à rotule sur rouleaux
Cuscinetti orientabili a rulli
Rodamientos de rodillos a rótula
Tweerijige tonlagers

Βαρελοειδή ρουλεμάν
Pallomaiset rullalaakerit
Rolamentos autocompensadores de rolos
Sfæriske rullelejer
Sfäriska rullager
Sfæriske rullelager

	€	d	D	B	min		€	d	D	B	min
21305 CC	133,09	25	62	17	5	* 22206 E/C3	123,75	30	62	20	5
21306 CC	151,10	30	72	19	5	* 22206 EK	***	30	62	20	5
21307 CC	165,22	35	80	21	5	* 22207 E	128,45	35	72	23	5
* 21308 E	182,07	40	90	23	5	* 22207 E/C3	128,45	35	72	23	5
* 21308 EKW	***	40	90	23	5	* 22207 EK	128,45	35	72	23	5
* 21308 EW	176,82	40	90	23	5	* 22207 EK/C3	***	35	72	23	5
* 21309 E	193,53	45	100	25	5	* 22208 E	139,08	40	80	23	5
* 21309 E/C3	***	45	100	25	5	* 22208 E/C3	139,08	40	80	23	5
* 21309 EK	***	45	100	25	5	* 22208 EK	139,08	40	80	23	5
* 21310 E	222,48	50	110	27		* 22208 EK/C3	***	40	80	23	5
* 21310 E/C3	229,06	50	110	27		* 22209 E	146,56	45	85	23	5
* 21310 EK	***	50	110	27		* 22209 E/C3	150,88	45	85	23	5
* 21311 E	260,38	55	120	29		* 22209 EK	146,56	45	85	23	5
* 21311 E/C3	***	55	120	29		* 22209 EK/C3	146,56	45	85	23	5
* 21311 EK	268,07	55	120	29		* 22210 E	155,27	50	90	23	5
* 21312 E	293,79	60	130	31		* 22210 E/C3	155,27	50	90	23	5
* 21312 E/C3	302,49	60	130	31		* 22210 EK	155,27	50	90	23	5
* 21312 EK	***	60	130	31		* 22210 EK/C3	155,27	50	90	23	5
* 21313 E	344,61	65	140	33		* 22211 E	172,10	55	100	25	5
* 21313 E/C3	***	65	140	33		* 22211 E/C3	172,10	55	100	25	5
* 21313 EK	354,82	65	140	33		* 22211 EK	172,10	55	100	25	5
* 21314 E	397,97	70	150	35		* 22211 EK/C3	172,10	55	100	25	5
* 21314 E/C3	***	70	150	35		* 22212 E	194,61	60	110	28	
* 21314 EK	***	70	150	35		* 22212 E/C3	194,61	60	110	28	
* 21315 E	443,63	75	160	37		* 22212 EK	194,61	60	110	28	
* 21315 EK	***	75	160	37		* 22212 EK/C3	194,61	60	110	28	
* 21316 E	499,53	80	170	39		* 22213 E	228,89	65	120	31	
* 21316 E/C3	***	80	170	39		* 22213 E/C3	228,89	65	120	31	
* 21316 EK	***	80	170	39		* 22213 EK	228,89	65	120	31	
* 21317 E	566,64	85	180	41		* 22213 EK/C3	228,89	65	120	31	
* 21317 EK	***	85	180	41		* 22214 E	261,94	70	125	31	
* 21318 E	645,40	90	190	43		* 22214 E/C3	261,94	70	125	31	
* 21318 EK	***	90	190	43		* 22214 EK	***	70	125	31	
* 21319 E	773,15	95	200	45		* 22215 E	287,48	75	130	31	
* 21319 EK	***	95	200	45		* 22215 E/C3	287,48	75	130	31	
* 21320 E	***	100	215	47		* 22215 E/C4	***	75	130	31	
* 21320 E/C3	***	100	215	47		* 22215 EK	287,48	75	130	31	
* 21320 EK	***	100	215	47		* 22215 EK/C3	287,48	75	130	31	
						* 22216 E	326,18	80	140	33	
						* 22216 E/C3	326,18	80	140	33	
* 22205 E	122,46	25	52	18	5	* 22216 EK	326,18	80	140	33	
* 22205 E/C3	120,65	25	52	18	5	* 22216 EK/C3	326,18	80	140	33	
* 22205 EK	***	25	52	18	5	* 22217 E	375,43	85	150	36	
* 22205/20 E	***	20	52	18	5	* 22217 E/C3	375,43	85	150	36	
* 22206 E	123,75	30	62	20	5	* 22217 EK	375,43	85	150	36	

* = Explorer ** = Explorer recommended range

	€	d	D	B	min		€	d	D	B	min
* 22217 EK/C3	375,43	85	150	36		* 22238 CCK/W33	***	190	340	92	
* 22218 E	436,55	90	160	40		* 22240 CC/W33	***	200	360	98	
* 22218 E/C3	436,55	90	160	40							
* 22218 EK	436,55	90	160	40							
* 22218 EK/C3	436,55	90	160	40							
* 22219 E	520,11	95	170	43		* 22308 E	194,61	40	90	33	5
* 22219 E/C3	535,50	95	170	43		* 22308 E/C3	191,72	40	90	33	5
* 22219 EK	521,88	95	170	43		* 22308 E/VA405	***	40	90	33	5
* 22219 EK/C3	535,50	95	170	43		* 22308 EK	***	40	90	33	5
2220 KM	894,09	100	180	46		* 22309 E	222,66	45	100	36	
* 22220 E	584,97	100	180	46							
* 22220 E/C3	584,97	100	180	46		* 22309 E/C3	219,34	45	100	36	
* 22220 EK	584,97	100	180	46		* 22309 E/VA405	***	45	100	36	
* 22220 EK/C3	584,97	100	180	46		* 22309 EK	222,66	45	100	36	
2222 KM	1121,06	110	200	53		* 22310 E	261,34	50	110	40	
						* 22310 E/C3	261,34	50	110	40	
* 22222 E	719,25	110	200	53							
* 22222 E/C3	757,09	110	200	53		* 22310 E/VA405	***	50	110	40	
* 22222 EK	719,25	110	200	53		* 22310 EK	261,34	50	110	40	
* 22222 EK/C3	757,09	110	200	53		* 22310 EK/C3	261,34	50	110	40	
* 22224 E	951,68	120	215	58		* 22311 E	306,84	55	120	43	
						* 22311 E/C3	306,84	55	120	43	
* 22224 E/C3	951,68	120	215	58							
* 22224 EK	951,68	120	215	58		* 22311 E/VA405	***	55	120	43	
* 22224 EK/C3	951,68	120	215	58		* 22311 EK	306,84	55	120	43	
* 22226 E	1126,32	130	230	64		* 22311 EK/C3	306,84	55	120	43	
* 22226 E/C3	1159,58	130	230	64		* 22312 E	356,13	60	130	46	
						* 22312 E/C3	356,13	60	130	46	
* 22226 EK	1126,32	130	230	64							
* 22226 EK/C3	1159,58	130	230	64		* 22312 E/VA405	***	60	130	46	
* 22228 CC/C3W33	1462,84	140	250	68		* 22312 EK	356,13	60	130	46	
* 22228 CC/W33	1420,86	140	250	68		* 22312 EK/C3	366,62	60	130	46	
* 22228 CCK/C3W33	1420,86	140	250	68		* 22313 E	414,12	65	140	48	
						* 22313 E/C3	426,31	65	140	48	
* 22228 CCK/W33	1420,86	140	250	68							
* 22230 CC/C3W33	1775,78	150	270	73		* 22313 E/VA405	***	65	140	48	
* 22230 CC/W33	1775,78	150	270	73		* 22313 EK	414,12	65	140	48	
* 22230 CCK/C3W33	1828,27	150	270	73		* 22313 EK/C3	414,12	65	140	48	
* 22230 CCK/W33	1775,78	150	270	73		* 22314 E	475,22	70	150	51	
						* 22314 E/C3	475,22	70	150	51	
* 22232 CC/C3W33	2351,94	160	290	80							
* 22232 CC/W33	2210,42	160	290	80		* 22314 E/VA405	591,99	70	150	51	
* 22232 CCK/C3W33	***	160	290	80		* 22314 EK	475,22	70	150	51	
* 22232 CCK/W33	2210,42	160	290	80		* 22314 EK/C3	***	70	150	51	
* 22234 CC/C3W33	***	170	310	86		* 22315 E	554,44	75	160	55	
						* 22315 E/C3	570,82	75	160	55	
* 22234 CC/W33	2813,02	170	310	86							
* 22234 CCK/W33	***	170	310	86		* 22315 E/VA405	662,63	75	160	55	
* 22236 CC/W33	3141,39	180	320	86		* 22315 EK	554,44	75	160	55	
* 22236 CCK/W33	***	180	320	86		* 22315 EK/C3	554,44	75	160	55	
* 22238 CC/W33	***	190	340	92		* 22316 E	628,62	80	170	58	
						* 22316 E/C3	628,62	80	170	58	

Spherical roller bearings
Pendelrollenlager
Roulements à rotule sur rouleaux
Cuscinetti orientabili a rulli
Rodamientos de rodillos a rótula
Tweerijige tonlagers

Βαρελοειδή ρουλεμάν
Pallomaiset rullalaakerit
Rolamentos autocompensadores de rolos
Sfæriske rullelejer
Sfäriska rullager
Sfæriske rullelager

	€	d	D	B	min		€	d	D	B	min
* 22316 EJA/VA405	***	80	170	58		* 22330 CCK/W33	***	150	320	108	
* 22316 EK	628,62	80	170	58		* 22332 CC/W33	***	160	340	114	
* 22316 EK/C3	628,62	80	170	58		* 22332 CCK/W33	***	160	340	114	
* 22317 E	710,95	85	180	60							
* 22317 E/C3	731,99	85	180	60							
* 22317 EJA/VA405	***	85	180	60		2308 EKTN9	***	40	90	33	
* 22317 EK	731,99	85	180	60		2309 EKTN9	156,19	45	100	36	
* 22317 EK/C3	731,99	85	180	60		* 23022 CC/C3W33	***	110	170	45	
* 22318 E	798,26	90	190	64		* 23022 CC/W33	627,49	110	170	45	
* 22318 E/C3	798,26	90	190	64		* 23024 CC/C3W33	751,95	120	180	46	
* 22318 EJA/VA405	925,49	90	190	64		* 23024 CC/W33	730,36	120	180	46	
* 22318 EK	821,85	90	190	64		* 23024 CCK/W33	730,36	120	180	46	
* 22318 EK/C3	821,85	90	190	64		* 23026 CC/C3W33	927,66	130	200	52	
* 22319 E	956,70	95	200	67		* 23026 CC/W33	897,61	130	200	52	
* 22319 E/C3	984,99	95	200	67		* 23026 CCK/W33	***	130	200	52	
* 22319 EJA/VA405	***	95	200	67		* 23028 CC/C3W33	1079,50	140	210	53	
* 22319 EK	984,99	95	200	67		* 23028 CC/W33	1044,50	140	210	53	
* 22319 EK/C3	984,99	95	200	67		* 23028 CCK/W33	1044,50	140	210	53	
* 22320 E	1148,29	100	215	73		* 23030 CC/C3W33	***	150	225	56	
* 22320 E/C3	1148,29	100	215	73		* 23030 CC/W33	1180,43	150	225	56	
* 22320 EJA/VA405	1383,43	100	215	73		* 23030 CCK/W33	1255,99	150	225	56	
* 22320 EK	1182,21	100	215	73		* 23032 CC/C3W33	1498,19	160	240	60	
* 22320 EK/C3	1182,21	100	215	73		* 23032 CC/W33	1408,02	160	240	60	
* 22322 E	1580,66	110	240	80		* 23032 CCK/W33	1498,19	160	240	60	
* 22322 E/C3	1580,66	110	240	80		* 23034 CC/W33	1674,69	170	260	67	
* 22322 EJA/VA405	1849,43	110	240	80		* 23034 CCK/W33	1730,79	170	260	67	
* 22322 EK	1580,66	110	240	80		* 23036 CC/W33	1960,65	180	280	74	
* 22322 EK/C3	1580,66	110	240	80		* 23036 CCK/W33	1960,65	180	280	74	
* 22324 CC/C3W33	1979,17	120	260	86		* 23038 CC/W33	2224,09	190	290	75	
* 22324 CC/W33	1979,17	120	260	86		* 23038 CCK/W33	***	190	290	75	
* 22324 CCJA/W33VA405	2315,44	120	260	86		* 23040 CC/W33	2506,07	200	310	82	
* 22324 CCK/C3W33	1979,17	120	260	86		* 23040 CCK/W33	2590,01	200	310	82	
* 22324 CCK/W33	1979,17	120	260	86		* 23044 CC/W33	3159,33	220	340	90	
* 22326 CC/C3W33	2422,65	130	280	93		* 23044 CCK/C4W33	***	220	340	90	
* 22326 CC/W33	2422,65	130	280	93		* 23044 CCK/W33	3361,66	220	340	90	
* 22326 CCJA/W33VA405	2834,39	130	280	93		* 23048 CC/C3W33	***	240	360	92	
* 22326 CCK/W33	2422,65	130	280	93		* 23048 CC/W33	***	240	360	92	
* 22328 CC/C3W33	***	140	300	102		* 23048 CCK/W33	***	240	360	92	
* 22328 CC/W33	3022,35	140	300	102							
* 22328 CCJA/W33VA405	3654,47	140	300	102							
* 22328 CCK/W33	3022,35	140	300	102		2310/C3	201,54	50	110	40	
* 22330 CC/C3W33	***	150	320	108		2311 K	249,11	55	120	43	
* 22330 CC/W33	***	150	320	108		2313 K	371,05	65	140	48	
* 22330 CCJA/W33VA405	***	150	320	108		2314/C3	460,67	70	150	51	
* 22330 CCK/C3W33	***	150	320	108		* 23120 CC/C3W33	676,50	100	165	52	

* = Explorer ** = Explorer recommended range

	€	d	D	B	min		€	d	D	B	min
* 23120 CC/W33	676,50	100	165	52		* 23222 CCK/C3W33	1045,40	110	200	69,8	
* 23120 CCK/W33	***	100	165	52		* 23222 CCK/W33	1045,40	110	200	69,8	
2316/C3	705,18	80	170	58		* 23224 CC/C3W33	1292,07	120	215	76	
* 23122 CC/C3W33	825,04	110	180	56		* 23224 CC/W33	1292,07	120	215	76	
* 23122 CC/W33	775,40	110	180	56		* 23224 CCK/C3W33	1292,07	120	215	76	
* 23122 CCK/C3W33	***	110	180	56		* 23224 CCK/W33	1292,07	120	215	76	
* 23122 CCK/W33	798,29	110	180	56		* 23226 CC/C3W33	***	130	230	80	
* 23124 CC/C3W33	***	120	200	62		* 23226 CC/W33	1539,65	130	230	80	
* 23124 CC/W33	1008,79	120	200	62		* 23226 CCK/C3W33	1539,65	130	230	80	
* 23124 CCK/W33	***	120	200	62		* 23226 CCK/W33	1539,65	130	230	80	
* 23126 CC/W33	1153,06	130	210	64		* 23228 CC/C3W33	***	140	250	88	
* 23126 CCK/W33	***	130	210	64		* 23228 CC/W33	1918,27	140	250	88	
* 23128 CC/W33	1347,70	140	225	68		* 23228 CCK/C3W33	1918,27	140	250	88	
* 23128 CCK/W33	***	140	225	68		* 23228 CCK/W33	1918,27	140	250	88	
* 23130 CC/C3W33	1778,68	150	250	80		* 23230 CC/C3W33	2487,38	150	270	96	
* 23130 CC/W33	1721,04	150	250	80		* 23230 CC/W33	2487,38	150	270	96	
* 23130 CCK/W33	***	150	250	80		* 23230 CCK/W33	2487,38	150	270	96	
* 23132 CC/C3W33	***	160	270	86		* 23232 CC/C3W33	***	160	290	104	
* 23132 CC/W33	2019,39	160	270	86		* 23232 CC/W33	2952,20	160	290	104	
* 23132 CCK/W33	***	160	270	86		* 23232 CCK/C3W33	***	160	290	104	
* 23134 CC/W33	2377,90	170	280	88		* 23232 CCK/W33	2952,20	160	290	104	
* 23134 CCK/C3W33	2377,90	170	280	88		* 23234 CC/C3W33	***	170	310	110	
* 23134 CCK/W33	2300,85	170	280	88		* 23234 CC/W33	***	170	310	110	
* 23136 CC/W33	2797,96	180	300	96		* 23234 CCK/W33	***	170	310	110	
* 23136 CCK/C3W33	***	180	300	96		* 23236 CC/C3W33	***	180	320	112	
* 23136 CCK/W33	2707,27	180	300	96		* 23236 CC/W33	***	180	320	112	
* 23138 CC/W33	3446,50	190	320	104		* 23236 CCK/W33	***	180	320	112	
* 23138 CCK/W33	3334,81	190	320	104		* 23238 CC/W33	***	190	340	120	
* 23140 CC/W33	***	200	340	112							
* 23140 CCK/C3W33	***	200	340	112							
* 23140 CCK/W33	***	200	340	112		23936 CC/W33	2184,69	180	250	52	
						23938 CC/W33	***	190	260	52	
						23940 CC/W33	2436,70	200	280	60	
						23944 CC/W33	2825,33	220	300	60	
						23948 CC/W33	2902,19	240	320	60	
* 23218 CC/C3W33	675,17	90	160	52,4		23952 CC/W33	***	260	360	75	
* 23218 CC/W33	675,17	90	160	52,4		23956 CC/W33	***	280	380	75	
* 23218 CCK/C3W33	675,17	90	160	52,4							
* 23218 CCK/W33	675,17	90	160	52,4							
* 23220 CC/C3W33	843,33	100	180	60,3							
* 23220 CC/W33	843,33	100	180	60,3		* 24024 CC/W33	1027,32	120	180	60	
* 23220 CCK/C3W33	843,33	100	180	60,3		* 24024 CCK30/W33	***	120	180	60	
* 23222 CC/C3W33	1076,29	110	200	69,8		* 24026 CC/C3W33	***	130	200	69	
* 23222 CC/W33	1045,40	110	200	69,8		* 24026 CC/W33	1217,67	130	200	69	
						* 24026 CCK30/W33	***	130	200	69	

* = Explorer ** = Explorer recommended range

Spherical roller bearings
Pendelrollenlager
Roulements à rotule sur rouleaux
Cuscinetti orientabili a rulli
Rodamientos de rodillos a rótula
Tweerijige tonlagers

Βαρελοειδή ρουλεμάν
Pallomaiset rullalaakerit
Rolamentos autocompensadores de rolos
Sfæriske rullelejer
Sfäriska rullager
Sfæriske rullelager

	€	d	D	B	min		€	d	D	B	min
* 24028 CC/W33	1403,79	140	210	69		* BS2-2212-2CS/VT143	262,72	60	110	34	
* 24028 CCK30/W33	***	140	210	69		* BS2-2216-2CS/VT143	440,34	80	140	40	
* 24030 CC/W33	1598,09	150	225	75							
* 24030 CCK30/W33	***	150	225	75							
* 24032 CC/C3W33	***	160	240	80							
* 24032 CC/W33	1830,66	160	240	80							
* 24032 CCK30/C3W33	***	160	240	80							
* 24032 CCK30/C4W33	***	160	240	80							
* 24032 CCK30/W33	***	160	240	80							
* 24034 CC/C3W33	***	170	260	90							
* 24034 CC/W33	2239,72	170	260	90							
* 24034 CCK30/W33	***	170	260	90							
* 24036 CC/C3W33	***	180	280	100							
* 24036 CC/W33	2639,24	180	280	100							
* 24036 CCK30/W33	***	180	280	100							
* 24038 CC/W33	***	190	290	100							
* 24038 CCK30/W33	***	190	290	100							
* 24040 CC/C3W33	***	200	310	109							
* 24040 CC/W33	3509,42	200	310	109							
* 24040 CCK30/W33	***	200	310	109							
* 24044 CC/W33	***	220	340	118							
* 24122 CC/C3W33	***	110	180	69							
* 24122 CC/W33	1165,02	110	180	69							
* 24122 CCK30/W33	***	110	180	69							
* 24124 CC/W33	1361,74	120	200	80							
* 24124 CCK30/W33	***	120	200	80							
* 24126 CC/W33	1708,89	130	210	80							
* 24126 CCK30/W33	***	130	210	80							
* 24128 CC/C3W33	***	140	225	85							
* 24128 CC/W33	2035,89	140	225	85							
* 24128 CCK30/W33	***	140	225	85							
* 24130 CC/C3W33	***	150	250	100							
* 24130 CC/W33	2439,70	150	250	100							
* 24130 CCK30/W33	***	150	250	100							
* 24132 CC/C3W33	***	160	270	109							
* 24132 CC/W33	***	160	270	109							
* 24132 CCK30/W33	***	160	270	109							
* 24134 CC/W33	***	170	280	109							
* 24134 CCK30/W33	***	170	280	109							
* 24136 CC/W33	***	180	300	118							
* 24136 CCK30/W33	***	180	300	118							

* = Explorer ** = Explorer recommended range

CARB®
 CARB®
 CARB®
 CARB®
 CARB®
 CARB®

CARB®
 CARB®
 CARB®
 CARB®
 CARB®
 CARB®

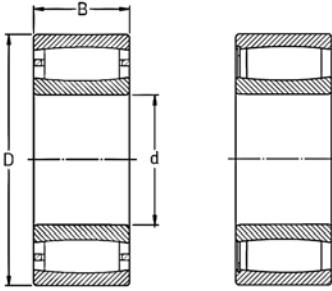

C 22	70
C 23	70
C 30	71
C 32	71
C 40	71
C 69	71

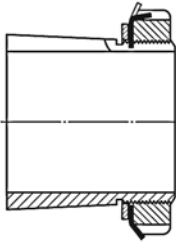

H 3 E	71
H 31 L	71

	€	d	D	B	min		€	d	D	B	min
* C 2206 TN9	***	30	62	20	5						
* C 2206 V	***	30	62	20	5						
* C 2207 KTN9	***	35	72	23	5						
* C 2207 TN9	***	35	72	23	5						
* C 2208 TN9	***	40	80	23	5						
* C 2208 V	***	40	80	23	5						
* C 2209 KTN9	***	45	85	23	5						
* C 2209 TN9	***	45	85	23	5						
* C 2210 KTN9	***	50	90	23	5						
* C 2210 TN9	***	50	90	23	5						
* C 2211 KTN9	***	55	100	25	5						
* C 2211 TN9	***	55	100	25	5						
* C 2212 KTN9	***	60	110	28							
* C 2212 TN9	***	60	110	28							
* C 2213 KTN9	***	65	120	31							
* C 2213 TN9	***	65	120	31							
* C 2214 TN9	***	70	125	31							
* C 2215	***	75	130	31							
* C 2215 K	***	75	130	31							
* C 2216	***	80	140	33							
* C 2216 K	***	80	140	33							
* C 2216 V	***	80	140	33							
* C 2217	***	85	150	36							
* C 2217 K	***	85	150	36							
* C 2218	***	90	160	40							
* C 2218 K	***	90	160	40							
* C 2220	***	100	180	46							
* C 2220 K	***	100	180	46							
* C 2222	***	110	200	53							
* C 2222 K	***	110	200	53							
* C 2314	***	70	150	51							
* C 2315 K	***	75	160	55							
* C 2316	***	80	170	58							
* C 2316 K	***	80	170	58							
* C 2320 K	***	100	215	73							

* = Explorer

	€	d	D	B	min		€	d	D	B	min
* C 3036 K	***	180	280	74	H 308 E	***	35	62	49		
					H 309 E	***	40	69	53		
					H 310 E	***	45	74	57		
					H 311 E	***	50	81	61		
					H 312 E	***	55	86	63		
* C 3224	***	120	215	76	H 313 E	***	60	92	67		
* C 3224 K	***	120	215	76	H 315 E	***	65	104	73		
					H 316 E	***	70	112	79		
					H 317 E	***	75	119	82		
					H 318 E	***	80	126	86		
* C 4020 V/C3	***	100	150	50	H 320 E	***	90	142	94		
* C 4024 V	***	120	180	60	H 322 E	***	100	145	77		
* C 6910 V	***	50	72	40	H 3128 L	***	125	172	121		
					H 3126 L	***	115	175	117		

* = Explorer

Ένσφαιρα ωστικά ρουλεμάν
 Painekeulalaakerit
 Rolamentos axiais de esferas
 Aksialkuglelejer
 Axialkullager
 Aksialkulelager

Thrust ball bearings
 Axial-Rillenkugellager
 Butées à billes
 Cuscinetti assiali a sfera
 Rodamientos axiales de bolas
 Axiale kogellagers

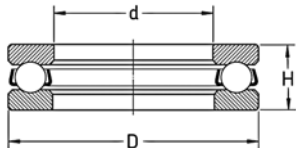

BA	75
511	75
512	75
513	75
514	76

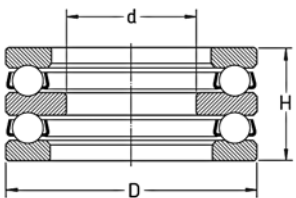

522	77
523	77
524	77

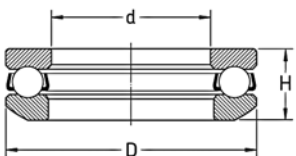

532	77
533	77

Thrust ball bearings
Axial-Rillenkugellager
Butées à billes
Cuscinetti assiali a sfera
Rodamientos axiales de bolas
Axiale kogellagers

Ένσφαιρα ωστικά ρουλεμάν
Paineakuulalaakerit
Rolamentos axiais de esferas
Aksialkuglelejer
Axialkullager
Aksialkulager

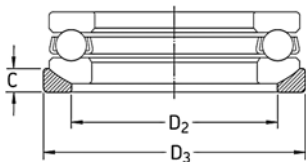

U 2	78
U 3	78

Ένσφαιρα ωστικά ρουλεμάν
Painekuulalaakerit
Rolamentos axiais de esferas
Aksialkuglelejer
Axialkullager
Aksialkulelager

Thrust ball bearings
Axial-Rillenkugellager
Butées à billes
Cuscinetti assiali a sfera
Rodamientos axiales de bolas
Axiale kogellagers

	€	d	D	H	min		€	d	D	H	min
BA 3	***	3	8	3,5	10	51164 M	***	320	400	63	
BA 4	***	4	10	4	10						
BA 5	***	5	12	4	10						
BA 6	***	6	14	5	10						
BA 7	***	7	17	6	10						
BA 8	***	8	19	7	10	51200	***	10	26	11	10
BA 9	***	9	20	7	10	51201	26,31	12	28	11	10
						51202	25,67	15	32	12	10
						51203	26,95	17	35	12	10
						51204	28,22	20	40	14	10
51100	21,09	10	24	9	10	51205	31,42	25	47	15	10
51101	21,17	12	26	9	10	51206	35,47	30	52	16	10
51102	20,92	15	28	9	10	51207	43,77	35	62	18	5
51103	21,17	17	30	9	10	51208	49,14	40	68	19	5
51104	21,21	20	35	10	10	51209	53,84	45	73	20	5
51105	23,46	25	42	11	10	51210	60,02	50	78	22	5
51106	25,25	30	47	11	10	51211	82,57	55	90	25	5
51107	26,89	35	52	12	10	51212	90,26	60	95	26	5
51108	32,50	40	60	13	5	51213	103,43	65	100	27	5
51109	37,03	45	65	14	5	51214	***	70	105	27	5
51110	40,29	50	70	14	5	51215	126,71	75	110	27	5
51111	49,97	55	78	16	5	51216	142,11	80	115	28	
51112	55,53	60	85	17	5	51217	183,55	85	125	31	
51113	60,14	65	90	18	5	51218	218,54	90	135	35	
51114	65,68	70	95	18	5	51220	290,70	100	150	38	
51115	74,53	75	100	19	5	51222	362,10	110	160	38	
51116	84,42	80	105	19	5	51224	449,34	120	170	39	
51117	95,50	85	110	19	5	51226	***	130	190	45	
51118	115,44	90	120	22		51228	***	140	200	46	
51120	179,58	100	135	25		51230 M	***	150	215	50	
51122	199,30	110	145	25		51232 M	***	160	225	51	
51124	249,00	120	155	25		51234 M	***	170	240	55	
51126	331,38	130	170	30		51236 M	***	180	250	56	
51128	416,75	140	180	31		51238 M	***	190	270	62	
51130 M	559,59	150	190	31		51240 M	***	200	280	62	
51132 M	736,71	160	200	31		51244 M	***	220	300	63	
51134 M	854,28	170	215	34		51248 M	***	240	340	78	
51136 M	***	180	225	34							
51138 M	***	190	240	37							
51140 M	1114,58	200	250	37							
51144 M	1367,19	220	270	37		51305	43,38	25	52	18	10
51148 M	1720,87	240	300	45		51306	49,49	30	60	21	5
51152 M	***	260	320	45		51307	60,02	35	68	24	5
51156 M	***	280	350	53		51308	73,39	40	78	26	5
51160 M	***	300	380	62		51309	***	45	85	28	5

Thrust ball bearings
Axial-Rillenkugellager
Butées à billes
Cuscinetti assiali a sfera
Rodamientos axiales de bolas
Axiale kogellagers

Ένσφαιρα ωστικά ρουλεμάν
Painekuuulaakerit
Rolamentos axiais de esferas
Aksialkuglelejer
Axialkullager
Aksialkulelager

	€	d	D	H	min		€	d	D	H	min
51310	114,73	50	95	31	5						
51311	***	55	105	35	5						
51312	178,73	60	110	35	5						
51313	***	65	115	36							
51314	287,82	70	125	40							
51315	***	75	135	44							
51316	385,79	80	140	44							
51317	***	85	150	49							
51318	***	90	155	50							
51320	***	100	170	55							
51322 M	***	110	190	63							
51324 M	***	120	210	70							
51326 M	***	130	225	75							
51328 M	***	140	240	80							
51330 M	***	150	250	80							
51332 M	***	160	270	87							
51334 M	***	170	280	87							
51405	***	25	60	24	5						
51406	***	30	70	28	5						
51407	***	35	80	32	5						
51408	140,87	40	90	36							
51409	***	45	100	39							
51410	229,27	50	110	43							
51411	***	55	120	48							
51412 M	***	60	130	51							
51413 M	***	65	140	56							
51414 M	***	70	150	60							
51415 M	***	75	160	65							
51416 M	***	80	170	68							
51420 M	***	100	210	85							

Ένσφαιρα ωστικά ρουλεμάν
Painekuulalaakerit
Rolamentos axiais de esferas
Aksialkuglelejer
Axialkullager
Aksialkulelager

Thrust ball bearings
Axial-Rillenkugellager
Butées à billes
Cuscinetti assiali a sfera
Rodamientos axiales de bolas
Axiale kogellagers

	€	d	D	H	min		€	d	D	H	min
52202	***	10	32	22	10	53201	***	12	28	11,4	10
52204	***	15	40	26	10	53202	***	15	32	13,3	10
52205	***	20	47	28	10	53203	***	17	35	13,2	10
52206	***	25	52	29	10	53204	***	20	40	14,7	10
52207	***	30	62	34	5	53205	***	25	47	16,7	10
52208	***	30	68	36		53206	***	30	52	17,8	10
52209	***	35	73	37		53207	***	35	62	19,9	5
52210	***	40	78	39		53208	***	40	68	20,3	5
52211	***	45	90	45		53209	***	45	73	21,3	5
52212	***	50	95	46		53210	***	50	78	23,5	5
52213	***	55	100	47		53211	***	55	90	27,4	5
52215	***	60	110	47		53212	***	60	95	28	5
52216	***	65	115	48		53213	***	65	100	28,7	5
52217	***	70	125	55		53214	***	70	105	28,8	5
52218	***	75	135	62		53215	***	75	110	28,4	5
52220	***	85	150	67		53216	***	80	115	29,5	
52224	***	100	170	68		53217	***	85	125	33,1	
52226	***	110	190	80		53218	***	90	135	38,5	
52228	***	120	200	81		53220	***	100	150	40,9	
52230 M	***	130	215	89		53222	***	110	160	40,2	
52232 M	***	140	225	90		53226	***	130	190	47,9	
52234 M	***	150	240	97		53228	***	140	200	48,6	
52305	***	20	52	34	10	53306	***	30	60	22,6	5
52306	***	25	60	38		53307	***	35	68	25,6	5
52307	***	30	68	44		53308	***	40	78	28,5	5
52308	***	30	78	49		53309	141,81	45	85	30,1	5
52309	***	35	85	52		53310	***	50	95	34,4	5
52310	***	40	95	58		53311	***	55	105	39,3	
52311	***	45	105	64		53312	***	60	110	38,3	
52312	***	50	110	64		53313	***	65	115	39,4	
52313	***	55	115	65		53314	***	70	125	44,2	
52314	***	55	125	72		53315	***	75	135	48,1	
52315	***	60	135	79		53316	***	80	140	47,6	
52316	***	65	140	79		53317	***	85	150	53,1	
						53318	***	90	155	54,6	
						53320	***	100	170	59,2	
						53322 M	***	110	190	67,2	
52406	***	20	70	52		53324 M	***	120	210	74,1	
52407	***	25	80	59							
52408	***	30	90	65							
52409	***	35	100	72							
52411	***	45	120	87							

Thrust ball bearings
 Axial-Rillenkugellager
 Butées à billes
 Cuscinetti assiali a sfera
 Rodamientos axiales de bolas
 Axiale kogellagers

Ένσφαιρα ωστικά ρουλεμάν
 Painekeuulalaakerit
 Rolamentos axiais de esferas
 Aksialkuglelejer
 Axialkullager
 Aksialkulelager

	€	D ₂	D ₃	C	min		€	D ₂	D ₃	C	min
U 202	***	24	35	4	10						
U 203	***	26	38	4	10						
U 204	***	30	42	5	10						
U 205	***	36	50	5,5	10						
U 206	***	42	55	5,5	5						
U 207	***	48	65	7	5						
U 208	***	55	72	7	5						
U 209	***	60	78	7,5	5						
U 210	***	62	82	7,5	5						
U 211	***	72	95	9	5						
U 212	***	78	100	9	5						
U 213	***	82	105	9	5						
U 214	***	88	110	9	5						
U 215	***	92	115	9,5							
U 216	***	98	120	10							
U 217	***	105	130	11							
U 218	***	110	140	13,5							
U 220	***	125	155	14							
U 222	***	135	165	14							
U 226	***	160	195	17							
U 228	***	170	210	17							
U 306	***	45	62	7	5						
U 307	***	52	72	7,5	5						
U 308	***	60	82	8,5	5						
U 309	***	65	90	10	5						
U 310	***	72	100	11	5						
U 311	***	80	110	11,5	5						
U 312	***	85	115	11,5							
U 313	***	90	120	12,5							
U 314	***	98	130	13							
U 315	***	105	140	15							
U 316	***	110	145	15							
U 317	***	115	155	17,5							
U 318	***	120	160	18							
U 320	***	135	175	18							
U 322	***	150	195	20,5							

Ωστικά βαρελοειδή ρουλεμάν
Pallomaiset painerullalaakerit
Rolamentos axiais autocompensadores de rolos
Sfæriske aksialrullelejer
Sfäriska axialrullager
Sfæriske aksialrullelager

Spherical roller thrust bearings
Axial-Pendelrollenlager
Butées à rotule sur rouleaux
Cuscinetti assiali orientabili a rulli
Rodamientos axiales de rodillos a rótula
Tontaatslagers

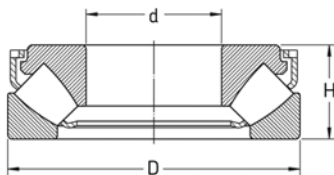

292	80
293	80
294	80

Spherical roller thrust bearings
 Axial-Pendelrollenlager
 Butées à rotule sur rouleaux
 Cuscinetti assiali orientabili a rulli
 Rodamientos axiales de rodillos a rótula
 Tontaatslagers

Ωστικά βαρελοειδή ρουλεμάν
 Pallomaiset painerullalaakerit
 Rolamentos axiais autocompensadores de rolos
 Sfæriske aksialrullelejer
 Sfäriska axialrullager
 Sfæriske aksialrullelager

	€	d	D	H	min		€	d	D	H	min
29240 E	***	200	280	48							
* 29317 E	1279,69	85	150	39							
* 29318 E	1231,80	90	155	39							
* 29320 E	1292,43	100	170	42							
* 29322 E	1485,08	110	190	48							
* 29324 E	1626,95	120	210	54							
* 29326 E	1845,63	130	225	58							
* 29328 E	2352,52	140	240	60							
* 29330 E	2465,99	150	250	60							
* 29332 E	2845,18	160	270	67							
* 29334 E	3128,09	170	280	67							
* 29336 E	3606,35	180	300	73							
* 29338 E	***	190	320	78							
* 29412 E	944,96	60	130	42							
* 29413 E	1026,89	65	140	45							
* 29414 E	1141,47	70	150	48							
* 29415 E	1215,68	75	160	51							
* 29416 E	1357,56	80	170	54							
* 29417 E	1614,33	85	180	58							
* 29418 E	1550,18	90	190	60							
* 29420 E	1918,51	100	210	67							
* 29422 E	2202,27	110	230	73							
* 29424 E	2621,36	120	250	78							
* 29426 E	3009,24	130	270	85							
* 29428 E	3701,15	140	280	85							
* 29430 E	***	150	300	90							
* 29432 E	***	160	320	95							

* = Explorer

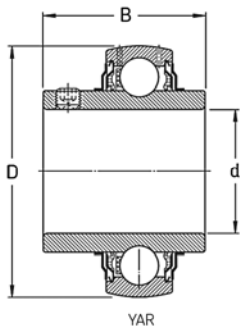

YAR 2	83
YAT 2	83

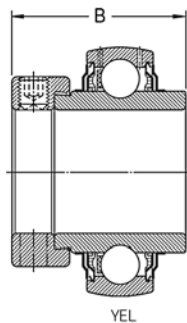

YEL 2	83
YET 2	83

ECL	84
ECL..B	84

Y-Bearings
Y-Lager
Roulements Y
Cuscinetti Y
Rodamientos Y
Y-lagers

Φλατζωτά και τύπου Ω έδρανα

Y-laakerit
Rolamentos Y
Y-lejer
Y-lager
Y-lager

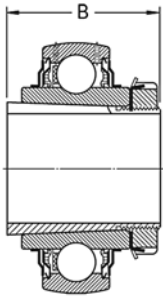

YSA



17262(00)
17263(00)

YSA 2	84
17262(00)	84
17263(00)	84

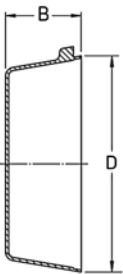

ECY

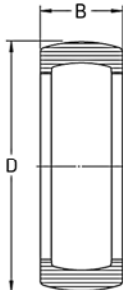

RIS

ECY	84
RIS	84

Y-laakerit

Rolamentos Y

Y-lejer

Y-lager

Y-lager

Y-Bearings

Y-Lager

Roulements Y

Cuscinetti Y

Rodamientos Y

Y-lagers

	€	d	D	B	min		€	d	D	B	min
YAR 203/12-2F	28,92	12	40	27,4		YAT 203	26,56	17	40	22,1	
YAR 203/15-2F	28,92	15	40	27,4		YAT 204	26,56	20	47	25,5	
YAR 203-2F	28,92	17	40	27,4		YAT 205	30,75	25	52	27,2	
YAR 204-012-2F	28,92	19,05	47	31		YAT 206	37,48	30	62	30,2	
YAR 204-2F	28,92	20	47	31		YAT 207	45,43	35	72	33	
YAR 204-2RF	32,39	20	47	31		YAT 208	54,32	40	80	36	
YAR 204-2RF/HV	129,51	20	47	31		YAT 209	***	45	85	37	
YAR 205-2F	33,43	25	52	34,1		YAT 210	***	50	90	38,8	
YAR 205-2RF	37,43	25	52	34,1							
YAR 205-2RF/HV	149,78	25	52	34,1							
YAR 205-100-2F	33,43	25,4	52	34,1		YEL 204-2F	***	20	47	43,7	
YAR 205-100-2RF	***	25,4	52	34,1		YEL 204-2RF/VL065	***	20	47	43,7	
YAR 206-2F	40,79	30	62	38,1		YEL 205-2F	43,75	25	52	44,4	
YAR 206-2RF	45,65	30	62	38,1		YEL 205-2RF/VL065	***	25	52	44,4	
YAR 206-2RF/HV	182,63	30	62	38,1		YEL 206-2F	53,59	30	62	48,4	
YAR 207-104-2F	***	31,75	72	42,9		YEL 206-2RF/VL065	66,98	30	62	48,4	
YAR 207-2F	49,37	35	72	42,9		YEL 207-2F	64,14	35	72	51,1	
YAR 207-2RF	55,31	35	72	42,9		YEL 207-2RF/VL065	80,15	35	72	51,1	
YAR 207-2RF/HV	221,20	35	72	42,9		YEL 208-2F	75,32	40	80	56,3	
YAR 208-108-2F	***	38,1	80	49,2		YEL 208-2RF/VL065	94,13	40	80	56,3	
YAR 208-108-2RF	***	38,1	80	49,2		YEL 209-2F	89,45	45	85	56,3	
YAR 208-2F	59,04	40	80	49,2		YEL 210-2F	96,63	50	90	62,7	
YAR 208-2RF	66,14	40	80	49,2		YEL 211-2F	120,44	55	100	71,4	
YAR 208-2RF/HV	264,54	40	80	49,2		YEL 212-2F	164,65	60	110	77,8	
YAR 209-112-2F	***	44,45	85	49,2							
YAR 209-2F	65,83	45	85	49,2		YET 203/15	30,83	15	40	28,6	
YAR 209-2RF	73,76	45	85	49,2		YET 203	30,83	17	40	28,6	
YAR 210-2F	74,74	50	90	51,6		YET 204-012	***	19,05	47	31	
YAR 210-2RF	83,70	50	90	51,6		YET 204	33,86	20	47	31	
YAR 211-200-2F	***	50,8	100	55,6		YET 205	36,59	25	52	31	
YAR 211-2F	97,00	55	100	55,6		YET 205/VL065	***	25	52	31	
YAR 211-2RF	***	55	100	55,6		YET 205-100	36,59	25,4	52	31	
YAR 212-2F	129,66	60	110	65,1		YET 206	43,75	30	62	35,7	
YAR 212-2RF	145,20	60	110	65,1		YET 206/VL065	***	30	62	35,7	
YAR 213-208-2F	***	63,5	120	68,3		YET 206-104	***	31,75	62	35,7	
YAR 213-2F	149,44	65	120	68,3		YET 207-104	***	31,75	72	38,9	
YAR 213-2RF	***	65	120	68,3		YET 207	53,34	35	72	38,9	
YAR 214-2F	226,73	70	125	69,9		YET 208-108	***	38,1	80	43,7	
YAR 215-2F	***	75	130	73,1		YET 208	64,53	40	80	43,7	
YAR 216-2F	348,78	80	140	77,9		YET 208/VL065	***	40	80	43,7	
YAR 218-2F	***	90	160	89		YET 209	77,11	45	85	43,7	
YAR 220-2F	***	100	180	98,4		YET 210	83,33	50	90	43,7	
						YET 211	101,36	55	100	48,4	
						YET 212	138,33	60	110	53,1	

**Y-Bearings
Y-Lager
Roulements Y
Cuscinetti Y
Rodamientos Y
Y-lagers**

**Φλατζωτά και τύπου Ω έδρανα
Y-laakerit
Rolamentos Y
Y-lejer
Y-lager
Y-lager**

	€	d	D	B	min		€	d	D	B	min
ECL 204	***		50,9	23		ECY 204	***	55	23		
ECL 205	***		55,8	25		ECY 205	***	60	23		
ECL 206	***		65	30		ECY 206	***	71	25		
ECL 207	***		75,4	30		ECY 207	***	81	27		
ECL 208	***		84,8	37		ECY 208	***	89	28,5		
ECL 204 B	***	20	50,9			ECY 209	***	94	29		
ECL 205 B	***	25	55,8			ECY 210	***	100	35,5		
ECL 206 B	***	30	65			ECY 212	***	120	42		
ECL 208 B	***	40	84,8								
YSA 205-2FK	***	25	52	24		RIS 203	***	35,5	47,3	18	
YSA 206-2FK	***	30	62	28		RIS 204	5,17	41,2	52,3	19	
YSA 207-2FK	***	35	72	30,5		RIS 205	***	46,4	62,3	20,5	
YSA 208-2FK	***	40	80	33,9		RIS 206 A	***	54,6	72,3	21,5	
YSA 209-2FK	65,83	45	85	35		RIS 207 A	***	63,7	80,3	23	
YSA 210-2FK	***	50	90	37		RIS 208 A	***	70,7	85,3	24	
YSA 211-2FK	97,00	55	100	40							
YSA 212-2FK	***	60	110	42,5							
YSA 213-2FK	149,44	65	120	43,5							
1726203-2RS1	19,96	17	40	12							
1726204-2RS1	21,55	20	47	14							
1726205-2RS1	24,41	25	52	15							
1726206-2RS1	29,89	30	62	16							
1726207-2RS1	35,76	35	72	17							
1726208-2RS1	44,83	40	80	18							
1726209-2RS1	51,05	45	85	19							
1726210-2RS1	57,22	50	90	20							
1726211-2RS1	***	55	100	21							
1726212-2RS1	***	60	110	22							
1726305-2RS1	***	25	62	17							
1726307-2RS1	***	35	80	21							
1726308-2RS1	***	40	90	23							
1726309-2RS1	***	45	100	25							
1726310-2RS1	***	50	110	27							

Y-bearing units
Y-Lagereinheiten
Paliers Y complets
Sopporti Y
Soportes con rodamientos Y
Y-lagerenheden

Φλατζωτά και τύπου Ω έδρανα
Y-laakeriyksiköt
Unidades de Rolamentos Y
Y-lejeenheder
Y-lagerenheter
Y-lagerenheter

Cast housings Έδρανα χυτοσίδηρου	Gussgehäuse Paliers avec corps en fonte Sopporti con corpo in ghisa Soportes de fundición Gietijzeren lagerhuizen	Valurautapesät Chumaceiras de ferro fundido Støbejernshuse Gjutna lagerhus Støpejernshus
Composite housings Έδρανα σύνθετου υλικού	Gehäuse aus Verbundwerkstoff Paliers avec corps composite Sopporti con corpo composito Soportes de material compuesto (de composite) Composiet huizen	Pesät materiaaliyhdistelmästä Chumaceira de material composito Komposithuse Komposithus Kompositthus
Pressed housings Έδρανα χυτοπρεσσαριστό	Stahlblechgehäuse Paliers en tôle Sopporti con corpo in lamiera stampata Soportes de chapa Plaatstalen huizen	Teräslevypesät Chumaceiras prensadas Pladejernshuse Pressade lagerhus Hus av presset ståplate
Plummer block units Έδρανα τύπου Ω	Stehlagereinheiten Paliers à semelle Sopporti ritti Soportes de pie Staande lagerhuizen	Pystylaakeriyksiköt Mancais com base Y-stålejeenheder Stålagerenheter Fotlagerenheter
Flanged units Έδρανα φλατζωτό	Flanschlagereinheiten Paliers appliqués Sopporti flangiati Soportes de brida Flenslagerhuizen	Laippalaakeriyksiköt Unidades com flange Y-flangelejeenheder Flänslagerenheter Flenslagerenheter
Take-up units Έδρανα τάνυσης	Spannlagereinheiten Coulisseaux-tendeurs Sopporti tenditori Soportes tensores Spanblokken	Säätölaakeriyksiköt Unidades tensoras Kulissestyrede Y-lejeenheder Spännlagerenheter Strammelagerenheter
Y-bearing units for adapter sleeves Έδρανα για ρουλεμάν με σφιγκτήρα άρμωσης	Y-Lagereinheiten für Spannhülsen Paliers Y pour montage sur manchons Sopporti Y con bussola di trazione Soportes con rodamientos Y sobre manguitos de fijación Y-lagerenheden met trekbus	Y-laakeriyksiköt kiristysholkilla Unidades de Rolamentos Y para casquilhos Y-lejeenheder med klembøsninger Y-lagerenheter för klämhylsa Y-lagerenheter med klemhylse

Έδρανα χυτοπρεσσαριστά
 Y-laakeriyksiköt, teräslevypesä
 Unidades de Rolamentos Y com chumaceiras
 prensadas
 Y-lejeenheder med huse af presset stålplade
 Y-lagerenheter med pressade lagerhus
 Y-lagerenheter med pressede stålhus

Y-bearing units with pressed housing
 Y-Lagereinheiten mit Stahlblechgehäuse
 Paliers Y avec corps en tôle
 Sopporti Y con corpo di lamiera stampata
 Soportes de chapa con rodamientos Y
 Y-lagereenheden met staalplaat huizen

SY .. FM	87
SY .. TF	87
SY .. TR	87
SYJ .. TF	88
SY .. VA201	88
SY .. VA228	88
SYF .. FM	89
SY .. WF	90
SYF .. TF	90
SYFJ	90
FY .. FM	91
FY .. TF	91
FY .. TR	91
FY .. WF	92
FY .. VA201	92
FY .. VA228	92
FYC	92
FYTB .. FM	92
FYTB .. TF	93
FYTB .. TR	93
FYTB .. WF	93
FYTF	93
FYTJ	93
TU .. TF	95
TU .. FM	95
TUJ	95
SYJ .. KF	96
FYJ .. KF	96
FYTJ .. KF	96
FYJ	97
SYFL	87
SYFL .. VE495	87
SYK .. TF	88
SYK .. TR	88
SYKC	88
SYL	88
SYL .. VE495	88
FYK .. TF	89
FYKC	89
FYK .. TR	89
FYTBKC	89
FYTBK .. TF	89
FYTBK .. TR	89
FYL	90
FYL .. VE495	90

FYTL ..	90
FYTL .. VE495	90
TUL	91
TUL .. VE495	91
P	87

Designations for Y-bearing units
 Bezeichnungssystem für Y-Lagereinheiten
 Désignations pour paliers Y
 Appellativi dei sopporti Y
 Designaciones de soportes con rodamientos Y
 Aanduidingsysteem voor Y-lagereenheden
 Y-laakeriyksiköiden merkintäjärjestelmä
 Designações das Unidades de Rolamentos Y
 Betegnelse for Y-lejeenheder
 Beteckningssystem för Y-lagerenheter
 Betegnelser for Y-lagerenheter
 Ονομασίες για φλατζωτά και τύπου Ω έδρανα

Example:				
	↑	↑	↑	↑
	housing	shaft diameter	bearing	seal
	Lagergehäuse	Wellendurchmesser	Lager	Dichtung
	corps du palier	diamètre d'arbre	roulement	joints d'étanchéité
	corpo	diametro albero	cuscinetto	tenute
	soporte	diámetro del eje	rodamiento	obturación
	huis	asdiameter	lager	afdichting
	pesä	akselin halkaisija	laakeri	tiiviste
	Chumaceira	diâmetro do veio	rolamento	Vedante
	hus	akseldiameter	leje	tætning
	hus	axeldiameter	lager	tätning
	hus	akseldiameter	lager	tetning
	Έδρανο	Διάμετρος άξονα	ρουλεμάν	Τσιμούχα

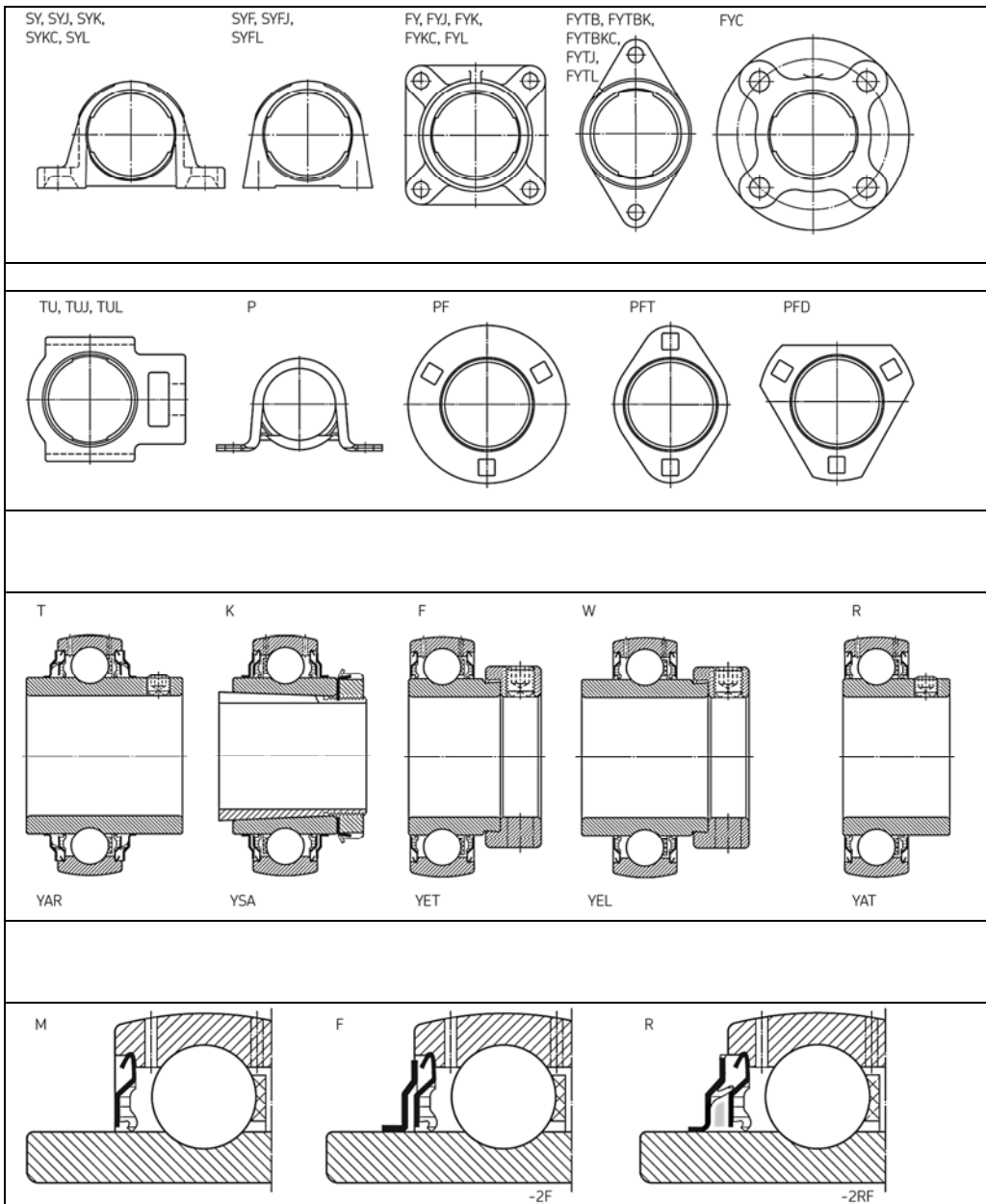

Y-bearing units with cast housing

Y-Lagereinheiten mit Gussgehäuse

Paliers Y avec corps en fonte

Sopporti Y con corpo in ghisa

Soportes de fundición con rodamientos Y

Y-lagereenheden met gietijzeren huizen

Έδρανα χυτοσίδηρου

Y-laakeriyksiköt, valurautapesä

Unidades de Rolamentos Y com chumaceira de ferro fundido

Y-lejeenheder med støbejernshuse

Y-lagerenheter med gjutna lagerus

Y-lagerenheter med stopejernshus

Unit Έδρανο	Einheit Paliers Sopporto Y Unidad Eenheid	Yksikkö Unidade Enhed Enhët Enhët
Shaft Άξονας	Welle Arbre Albero Eje As	Akseli Veio Aksel Axel Aksel
Housing Κέλυφος	Gehäuse Corps de paliers Corpo Soporte Huis	Pesä Chumaceira Hus Hus Hus
Bearing Ρουλεμάν	Lager Roulement Cuscinetto Rodamiento Lager	Laakeri Rolamento Leje Lager Lager
End cover Καπάκι	Abschlussdeckel Couvercle Coperchio di estremità Tapa lateral Eindeksel	Päätykansi Tampa Endedæksel Ändlock Endelokk
Adapter sleeve Σφιγκτήρας άρμωσης	Spannhülse Manchon de serrage Bussola di trazione Manguito de fijación Trekbus	Kiristysholkki Casquilho Klembøsning Klãmhylsa Klemhylse

Y-bearing units with cast housing
Y-Lagereinheiten mit Gussgehäuse
Paliers Y avec corps en fonte
Sopporti Y con corpo in ghisa
Soportes de fundición con rodamientos Y
Y-lagereenheden met gietijzeren huizen

Εόρανα χυτοσίδηρου
Y-laakeriyksiköt, valurautapesä
Unidades de Rolamentos Y com chumaceira de ferro fundido
Y-lejeenheder med støbejernshuse
Y-lagerenheter med gjutna lagerus
Y-lagerenheter med støpejernshus

Unit	Shaft	€	Housing	Bearing	€	End cover	€
SY 15 FM	15	***	SY 503 M	YET 203/15	30,83		
SY 17 FM	17	***	SY 503 M	YET 203	30,83		
SY 20 FM	20	52,55	SY 504 M	YET 204	33,86	ECY 204	***
SY 25 FM	25	59,60	SY 505 M	YET 205	36,59	ECY 205	***
SY 30 FM	30	70,96	SY 506 M	YET 206	43,75	ECY 206	***
SY 35 FM	35	83,31	SY 507 M	YET 207	53,34	ECY 207	***
SY 40 FM	40	97,18	SY 508 M	YET 208	64,53	ECY 208	***
SY 45 FM	45	116,00	SY 509 M	YET 209	77,11	ECY 209	***
SY 50 FM	50	130,94	SY 510 M	YET 210	83,33	ECY 210	***
SY 55 FM	55	***	SY 511 M	YET 211	101,36	ECY 211	***
SY 60 FM	60	210,64	SY 512 M	YET 212	138,33	ECY 212	***
SY 12 TF	12	***	SY 503 M	YAR 203/12-2F	28,92		
SY 15 TF	15	***	SY 503 M	YAR 203/15-2F	28,92		
SY 17 TF	17	***	SY 503 M	YAR 203-2F	28,92		
SY 20 TF	20	47,50	SY 504 M	YAR 204-2F	28,92	ECY 204	***
SY 25 TF	25	56,37	SY 505 M	YAR 205-2F	33,43	ECY 205	***
SY 30 TF	30	67,92	SY 506 M	YAR 206-2F	40,79	ECY 206	***
SY 35 TF	35	79,25	SY 507 M	YAR 207-2F	49,37	ECY 207	***
SY 40 TF	40	91,57	SY 508 M	YAR 208-2F	59,04	ECY 208	***
SY 45 TF	45	104,51	SY 509 M	YAR 209-2F	65,83	ECY 209	***
SY 50 TF	50	122,20	SY 510 M	YAR 210-2F	74,74	ECY 210	***
SY 55 TF	55	160,38	SY 511 M	YAR 211-2F	97,00	ECY 211	***
SY 60 TF	60	201,98	SY 512 M	YAR 212-2F	129,66	ECY 212	***
SY 65 TF	65	250,23	SY 513 M	YAR 213-2F	149,44	ECY 213	***
SY 1. TF	25,4	***	SY 505 M	YAR 205-100-2F	33,43	ECY 205	***
SY 1.1/2 TF	38,1	***	SY 508 M	YAR 208-108-2F	***	ECY 208	***
SY 1.1/4 TF	31,75	***	SY 507 M	YAR 207-104-2F	***	ECY 207	***
SY 1.3/4 TF	44,45	***	SY 509 M	YAR 209-112-2F	***	ECY 209	***
SY 2. TF	50,8	***	SY 511 M	YAR 211-200-2F	***	ECY 211	***
SY 2.1/2 TF	63,5	***	SY 513 M	YAR 213-208-2F	***	ECY 213	***
SY 3/4 TF	19,05	***	SY 504 M	YAR 204-012-2F	28,92	ECY 204	***
SY 20 TR	20	***	SY 504 M	YAR 204-2RF	32,39	ECY 204	***
SY 25 TR	25	***	SY 505 M	YAR 205-2RF	37,43	ECY 205	***
SY 30 TR	30	***	SY 506 M	YAR 206-2RF	45,65	ECY 206	***
SY 35 TR	35	***	SY 507 M	YAR 207-2RF	55,31	ECY 207	***
SY 40 TR	40	***	SY 508 M	YAR 208-2RF	66,14	ECY 208	***
SY 45 TR	45	***	SY 509 M	YAR 209-2F	65,83	ECY 209	***
SY 50 TR	50	131,32	SY 510 M	YAR 210-2F	74,74	ECY 210	***
SY 55 TR	55	***	SY 511 M	YAR 211-2F	97,00	ECY 211	***
SY 60 TR	60	***	SY 512 M	YAR 212-2F	129,66	ECY 212	***

Έδρανα χυτοσίδηρου

Y-laakeriyksiköt, valurautapesä

Unidades de Rolamentos Y com chumaceira de ferro fundido

Y-lejeenheder med støbejernshuse

Y-lagerenheter med gjutna lagerus

Y-lagerenheter med stopejernshus

Y-bearing units with cast housing

Y-Lagereinheiten mit Gussgehäuse

Paliers Y avec corps en fonte

Sopporti Y con corpo in ghisa

Soportes de fundición con rodamientos Y

Y-lageereenheden met gietijzeren huizen

Unit	Shaft	€	Housing	Bearing	€	End cover	€
SYJ 100 TF	100	841,11	SYJ 520	YAR 220-2F	***		
SYJ 20 TF	20	***	SYJ 504	YAR 204-2F	28,92		
SYJ 25 TF	25	56,37	SYJ 505	YAR 205-2F	33,43		
SYJ 30 TF	30	67,92	SYJ 506	YAR 206-2F	40,79		
SYJ 35 TF	35	79,25	SYJ 507	YAR 207-2F	49,37		
SYJ 40 TF	40	91,57	SYJ 508	YAR 208-2F	59,04		
SYJ 45 TF	45	104,51	SYJ 509	YAR 209-2F	65,83		
SYJ 50 TF	50	122,20	SYJ 510	YAR 210-2F	74,74		
SYJ 55 TF	55	***	SYJ 511	YAR 211-2F	97,00		
SYJ 60 TF	60	201,98	SYJ 512	YAR 212-2F	129,66		
SYJ 65 TF	65	***	SYJ 513	YAR 213-2F	149,44		
SYJ 70 TF	70	372,11	SYJ 514	YAR 214-2F	226,73		
SYJ 75 TF	75	***	SYJ 515	YAR 215-2F	***		
SYJ 80 TF	80	523,23	SYJ 516	YAR 216-2F	348,78		
SYJ 90 TF	90	737,17	SYJ 518	YAR 218-2F	***		
SY 20 TF/VA201	20	***		YAR 204-2FW/VA201	***		
SY 25 TF/VA201	25	***					
SY 30 TF/VA201	30	***		YAR 206-2FW/VA201	***		
SY 35 TF/VA201	35	***					
SY 40 TF/VA201	40	***		YAR 208-2FW/VA201	***		
SY 50 TF/VA201	50	***					
SY 60 TF/VA201	60	***					
SY 20 TF/VA228	20	***		YAR 204-2FW/VA228	***		
SY 25 TF/VA228	25	***		YAR 205-2FW/VA228	***		
SY 30 TF/VA228	30	***		YAR 206-2FW/VA228	***		
SY 35 TF/VA228	35	***		YAR 207-2FW/VA228	***		
SY 40 TF/VA228	40	***		YAR 208-2FW/VA228	***		
SY 45 TF/VA228	45	***					
SY 50 TF/VA228	50	***		YAR 210-2FW/VA228	***		
SY 55 TF/VA228	55	***					
SY 60 TF/VA228	60	***					

Y-bearing units with cast housing
 Y-Lagereinheiten mit Gussgehäuse
 Paliers Y avec corps en fonte
 Sopporti Y con corpo in ghisa
 Soportes de fundición con rodamientos Y
 Y-lagereenheden met gietijzeren huizen

Έδρανα χυτοσίδηρου
 Y-laakeriyksiköt, valurautapesä
 Unidades de Rolamentos Y com chumaceira de ferro fundido
 Y-lejeenheder med støbejernshuse
 Y-lagerenheter med gjutna lagerus
 Y-lagerenheter med stopejernshus

Unit	Shaft	€	Housing	Bearing	€	End cover	€
SYF 20 FM	20	***	SYF 504	YET 204	33,86		
SYF 25 FM	25	***	SYF 505	YET 205	36,59		
SYF 30 FM	30	***	SYF 506	YET 206	43,75		
SYF 35 FM	35	***	SYF 507	YET 207	53,34		
SYF 40 FM	40	***	SYF 508	YET 208	64,53		
SYF 45 FM	45	***	SYF 509	YET 209	77,11		
SYF 50 FM	50	***	SYF 510	YET 210	83,33		

Έδρανα χυτοσίδηρου

Y-laakeriyksiköt, valurautapesä

Unidades de Rolamentos Y com chumaceira de ferro fundido

Y-lejeenheder med støbejernshuse

Y-lagerenheter med gjutna lagerus

Y-lagerenheter med stopejernshus

Y-bearing units with cast housing

Y-Lagereinheiten mit Gussgehäuse

Paliers Y avec corps en fonte

Sopporti Y con corpo in ghisa

Soportes de fundición con rodamientos Y

Y-lageereenheden met gietijzeren huizen

Unit	Shaft	€	Housing	Bearing	€	End cover	€
SY 20 WF	20	***	SY 504 M	YEL 204-2F	***	ECY 204	***
SY 25 WF	25	***	SY 505 M	YEL 205-2F	43,75	ECY 205	***
SY 30 WF	30	***	SY 506 M	YEL 206-2F	53,59	ECY 206	***
SY 30 WF	30	***	SY 506 M	YEL 206-2F	53,59	ECY 206	***
SY 35 WF	35	***	SY 507 M	YEL 207-2F	64,14	ECY 207	***
SY 40 WF	40	***	SY 508 M	YEL 208-2F	75,32	ECY 208	***
SY 45 WF	45	***	SY 509 M	YEL 209-2F	89,45	ECY 209	***
SY 50 WF	50	***	SY 510 M	YEL 210-2F	96,63	ECY 210	***
SY 55 WF	55	***	SY 511 M	YEL 211-2F	120,44	ECY 211	***
SY 60 WF	60	***	SY 512 M	YEL 212-2F	164,65	ECY 212	***
SYF 20 TF	20	53,65	SYF 504	YAR 204-2F	28,92		
SYF 25 TF	25	63,85	SYF 505	YAR 205-2F	33,43		
SYF 30 TF	30	78,91	SYF 506	YAR 206-2F	40,79		
SYF 35 TF	35	92,43	SYF 507	YAR 207-2F	49,37		
SYF 40 TF	40	111,07	SYF 508	YAR 208-2F	59,04		
SYF 45 TF	45	***	SYF 509	YAR 209-2F	65,83		
SYF 50 TF	50	140,13	SYF 510	YAR 210-2F	74,74		
SYFJ 20 TF	20	***	SYFJ 504	YAR 204-2F	28,92		
SYFJ 25 TF	25	***	SYFJ 505	YAR 205-2F	33,43		
SYFJ 30 TF	30	***	SYFJ 506	YAR 206-2F	40,79		
SYFJ 35 TF	35	***	SYFJ 507	YAR 207-2F	49,37		
SYFJ 40 TF	40	***	SYFJ 508	YAR 208-2F	59,04		
SYFJ 45 TF		***	SYFJ 509	YAR 209-2F	65,83		
SYFJ 50 TF		***	SYFJ 510	YAR 210-2F	74,74		

Y-bearing units with cast housing
Y-Lagereinheiten mit Gussgehäuse
Paliers Y avec corps en fonte
Sopporti Y con corpo in ghisa
Soportes de fundición con rodamientos Y
Y-lagereenheden met gietijzeren huizen

Εόρανα χυτοσίδηρου
Y-laakeriyksiköt, valurautapesä
Unidades de Rolamentos Y com chumaceira de ferro fundido
Y-lejeenheder med støbejernshuse
Y-lagerenheter med gjutna lagerus
Y-lagerenheter med støpejernshus

Unit	Shaft	€	Housing	Bearing	€	End cover	€
FY 15 FM	17	***	FY 503 M	YET 203/15	30,83		
FY 17 FM	17	***	FY 503 M	YET 203	30,83		
FY 20 FM	20	***	FY 504 M	YET 204	33,86	ECY 204	***
FY 25 FM	25	58,49	FY 505 M	YET 205	36,59	ECY 205	***
FY 30 FM	30	69,63	FY 506 M	YET 206	43,75	ECY 206	***
FY 35 FM	35	83,31	FY 507 M	YET 207	53,34	ECY 207	***
FY 40 FM	40	97,18	FY 508 M	YET 208	64,53	ECY 208	***
FY 45 FM	45	116,00	FY 509 M	YET 209	77,11	ECY 209	***
FY 50 FM	50	130,94	FY 510 M	YET 210	83,33	ECY 210	***
FY 504 M		***					
FY 55 FM	55	***	FY 511 M	YET 211	101,36	ECY 211	***
FY 60 FM	60	***	FY 512 M	YET 212	138,33	ECY 212	***
FY 1. TF	25	***	FY 505 M	YAR 205-100-2F	33,43	ECY 205	***
FY 1.1/2 TF	40	***	FY 508 M	YAR 208-108-2F	***	ECY 208	***
FY 1.1/4 TF	35	***	FY 507 M	YAR 207-104-2F	***	ECY 207	***
FY 1.3/4 TF	45	***	FY 509 M	YAR 209-112-2F	***		
FY 12 TF	17	***	FY 503 M	YAR 203/12-2F	28,92		
FY 15 TF	17	***	FY 503 M	YAR 203/15-2F	28,92		
FY 17 TF	17	***	FY 503 M	YAR 203-2F	28,92		
FY 20 TF	20	46,60	FY 504 M	YAR 204-2F	28,92	ECY 204	***
FY 25 TF	25	55,32	FY 505 M	YAR 205-2F	33,43	ECY 205	***
FY 30 TF	30	66,65	FY 506 M	YAR 206-2F	40,79	ECY 206	***
FY 35 TF	35	79,25	FY 507 M	YAR 207-2F	49,37	ECY 207	***
FY 40 TF	40	91,57	FY 508 M	YAR 208-2F	59,04	ECY 208	***
FY 45 TF	45	104,51	FY 509 M	YAR 209-2F	65,83	ECY 209	***
FY 50 TF	50	122,20	FY 510 M	YAR 210-2F	74,74	ECY 210	***
FY 55 TF	55	160,38	FY 511 M	YAR 211-2F	97,00	ECY 211	***
FY 60 TF	60	201,98	FY 512 M	YAR 212-2F	129,66	ECY 212	***
FY 65 TF	65	250,23	FY 513 M	YAR 213-2F	149,44	ECY 213	***
FY 2. TF	50,8	***	FY 511 M	YAR 211-200-2F	***	ECY 211	***
FY 2.1/2 TF	63,5	***	FY 513 M	YAR 213-208-2F	***	ECY 213	***
FY 3/4 TF	19,05	***	FY 504 M	YAR 204-012-2F	28,92	ECY 204	***
FY 20 TR	20	***	FY 504 M	YAR 204-2RF	32,39	ECY 204	***
FY 25 TR	25	***	FY 505 M	YAR 205-2RF	37,43	ECY 205	***
FY 30 TR	30	***	FY 506 M	YAR 206-2RF	45,65	ECY 206	***
FY 35 TR	35	***	FY 507 M	YAR 207-2RF	55,31	ECY 207	***
FY 40 TR	40	***	FY 508 M	YAR 208-2RF	66,14	ECY 208	***
FY 45 TR	45	***	FY 509 M	YAR 209-2RF	73,76	ECY 209	***
FY 50 TR	50	***	FY 510 M	YAR 210-2RF	83,70	ECY 210	***
FY 55 TR	55	***	FY 511 M	YAR 211-2RF	***	ECY 211	***
FY 60 TR	60	***	FY 512 M	YAR 212-2RF	145,20	ECY 212	***

Έδρανα χυτοσίδηρου

Y-laakeriyksiköt, valurautapesä

Unidades de Rolamentos Y com chumaceira de ferro fundido

Y-lejeenheder med støbejernshuse

Y-lagerenheter med gjutna lagerus

Y-lagerenheter med støpejernshus

Y-bearing units with cast housing

Y-Lagereinheiten mit Gussgehäuse

Paliers Y avec corps en fonte

Sopporti Y con corpo in ghisa

Soportes de fundición con rodamientos Y

Y-lagereenheden met gietijzeren huizen

Unit	Shaft	€	Housing	Bearing	€	End cover	€
FY 25 WF	25	***	FY 505 M	YEL 205-2F	43,75	ECY 205	***
FY 30 WF	30	***	FY 506 M	YEL 206-2F	53,59	ECY 206	***
FY 35 WF	35	***	FY 507 M	YEL 207-2F	64,14	ECY 207	***
FY 40 WF	40	***	FY 508 M	YEL 208-2F	75,32	ECY 208	***
FY 45 WF	45	***	FY 509 M	YEL 209-2F	89,45	ECY 209	***
FY 50 WF	50	***	FY 510 M	YEL 210-2F	96,63	ECY 210	***
FY 55 WF	55	***	FY 511 M	YEL 211-2F	120,44	ECY 211	***
FY 60 WF	60	***	FY 512 M	YEL 212-2F	164,65	ECY 212	***
FY 25 TF/VA201	25	***					
FY 30 TF/VA201	30	***		YAR 206-2FW/VA201	***		
FY 40 TF/VA201	40	***		YAR 208-2FW/VA201	***		
FY 50 TF/VA201	50	***					
FY 60 TF/VA201	60	***					
FY 20 TF/VA228	20	***		YAR 204-2FW/VA228	***		
FY 25 TF/VA228	25	***		YAR 205-2FW/VA228	***		
FY 30 TF/VA228	30	***		YAR 206-2FW/VA228	***		
FY 35 TF/VA228	35	***					
FY 40 TF/VA228	40	***		YAR 208-2FW/VA228	***		
FY 45 TF/VA228	45	***					
FY 50 TF/VA228	50	***		YAR 210-2FW/VA228	***		
FY 55 TF/VA228	55	***					
FY 60 TF/VA228	60	***					
FYC 20 TF	20	***	FYC 504	YAR 204-2F	28,92		
FYC 25 TF	25	***	FYC 505	YAR 205-2F	33,43		
FYC 30 TF	30	***	FYC 506	YAR 206-2F	40,79		
FYC 35 TF	35	98,14	FYC 507	YAR 207-2F	49,37		
FYC 40 TF	40	115,44	FYC 508	YAR 208-2F	59,04		
FYC 45 TF	45	***	FYC 509	YAR 209-2F	65,83		
FYC 50 TF	50	146,33	FYC 510	YAR 210-2F	74,74		
FYC 55 TF	55	***	FYC 511	YAR 211-2F	97,00		
FYC 60 TF	60	***	FYC 512	YAR 212-2F	129,66		
FYC 65 TF	65	***	FYC 513	YAR 213-2F	149,44		
FYTB 15 FM	15	***	FYTB 503 M	YET 203/15	30,83		
FYTB 17 FM	17	***	FYTB 503 M	YET 203	30,83		
FYTB 20 FM	20	52,55	FYTB 504 M	YET 204	33,86	ECY 204	***
FYTB 25 FM	25	59,60	FYTB 505 M	YET 205	36,59	ECY 205	***
FYTB 30 FM	30	70,96	FYTB 506 M	YET 206	43,75	ECY 206	***
FYTB 35 FM	35	83,31	FYTB 507 M	YET 207	53,34	ECY 207	***
FYTB 40 FM	40	97,18	FYTB 508 M	YET 208	64,53	ECY 208	***
FYTB 45 FM	45	***	FYTB 509 M	YET 209	77,11	ECY 209	***
FYTB 50 FM	50	130,94	FYTB 510 M	YET 210	83,33	ECY 210	***

Y-bearing units with cast housing
Y-Lagereinheiten mit Gussgehäuse
Paliers Y avec corps en fonte
Sopporti Y con corpo in ghisa
Soportes de fundición con rodamientos Y
Y-lagereenheden met gietijzeren huizen

Εἴσπρα χυτοσίδηρου
Y-laakeriyksiköt, valurautapesä
Unidades de Rolamentos Y com chumaceira de ferro fundido
Y-lejeenheder med støbejernshuse
Y-lagerenheter med gjutna lagerus
Y-lagerenheter med støpejernshus

Unit	Shaft	€	Housing	Bearing	€	End cover	€
FYTB 12 TF	12	***	FYTB 503 M	YAR 203/12-2F	28,92		
FYTB 15 TF	15	46,60	FYTB 503 M	YAR 203/15-2F	28,92		
FYTB 17 TF	17	46,60	FYTB 503 M	YAR 203-2F	28,92		
FYTB 20 TF	20	47,50	FYTB 504 M	YAR 204-2F	28,92	ECY 204	***
FYTB 25 TF	25	56,37	FYTB 505 M	YAR 205-2F	33,43	ECY 205	***
FYTB 30 TF	30	67,92	FYTB 506 M	YAR 206-2F	40,79	ECY 206	***
FYTB 35 TF	35	79,25	FYTB 507 M	YAR 207-2F	49,37	ECY 207	***
FYTB 40 TF	40	91,57	FYTB 508 M	YAR 208-2F	59,04	ECY 208	***
FYTB 45 TF	45	104,51	FYTB 509 M	YAR 209-2F	65,83	ECY 209	***
FYTB 50 TF	50	122,20	FYTB 510 M	YAR 210-2F	74,74	ECY 210	***
FYTB 1. TF	25,4	***	FYTB 505 M	YAR 205-100-2F	33,43	ECY 205	***
FYTB 1.1/2 TF	38,1	***	FYTB 508 M	YAR 208-108-2F	***	ECY 208	***
FYTB 1.1/4 TF	31,75	***	FYTB 507 M	YAR 207-104-2F	***	ECY 207	***
FYTB 1.3/4 TF	44,45	***	FYTB 509 M	YAR 209-112-2F	***	ECY 209	***
FYTB 3/4 TF	19,05	***	FYTB 504 M	YAR 204-012-2F	28,92	ECY 204	***
FYTB 20 TR	20	***	FYTB 504 M	YAR 204-2RF	32,39	ECY 204	***
FYTB 25 TR	25	***	FYTB 505 M	YAR 205-2RF	37,43	ECY 205	***
FYTB 30 TR	30	***	FYTB 506 M	YAR 206-2RF	45,65	ECY 206	***
FYTB 35 TR	35	***	FYTB 507 M	YAR 207-2RF	55,31	ECY 207	***
FYTB 40 TR	40	***	FYTB 508 M	YAR 208-2RF	66,14	ECY 208	***
FYTB 45 TR		***	FYTB 509 M	YAR 209-2RF	73,76	ECY 209	***
FYTB 50 TR	50	***	FYTB 510 M	YAR 210-2RF	83,70	ECY 210	***
FYTB 20 WF		***	FYTB 504 M	YEL 204-2F	***	ECY 204	***
FYTB 25 WF	25	***	FYTB 505 M	YEL 205-2F	43,75	ECY 205	***
FYTB 30 WF	30	***	FYTB 506 M	YEL 206-2F	53,59	ECY 206	***
FYTB 35 WF	35	***	FYTB 507 M	YEL 207-2F	64,14	ECY 207	***
FYTB 40 WF	40	***	FYTB 508 M	YEL 208-2F	75,32	ECY 208	***
FYTB 45 WF		***	FYTB 509 M	YEL 209-2F	89,45	ECY 209	***
FYTB 50 WF	50	***	FYTB 510 M	YEL 210-2F	96,63	ECY 210	***
FYTF 505		27,20					
FYTF 506		***					
FYTJ 20 TF	20	***	FYTJ 504	YAR 204-2F	28,92		
FYTJ 25 TF	25	56,37	FYTJ 505	YAR 205-2F	33,43		
FYTJ 30 TF	30	67,92	FYTJ 506	YAR 206-2F	40,79		
FYTJ 35 TF	35	***	FYTJ 507	YAR 207-2F	49,37		
FYTJ 40 TF	40	***	FYTJ 508	YAR 208-2F	59,04		

Έδρανα χυτοσίδηρου

Y-laakeriyksiköt, valurautapesä

Unidades de Rolamentos Y com chumaceira de ferro fundido

Y-lejeenheder med støbejernshuse

Y-lagerenheter med gjutna lagerus

Y-lagerenheter med stopejernshus

Y-bearing units with cast housing

Y-Lagereinheiten mit Gussgehäuse

Paliers Y avec corps en fonte

Sopporti Y con corpo in ghisa

Soportes de fundición con rodamientos Y

Y-lagereenheden met gietijzeren huizen

Unit	Shaft	€	Housing	Bearing	€	End cover	€
FYTJ 45 TF	45	***	FYTJ 509	YAR 209-2F	65,83		
FYTJ 50 TF	50	***	FYTJ 510	YAR 210-2F	74,74		

Y-bearing units with cast housing
 Y-Lagereinheiten mit Gussgehäuse
 Paliers Y avec corps en fonte
 Sopporti Y con corpo in ghisa
 Soportes de fundición con rodamientos Y
 Y-lagereenheden met gietijzeren huizen

Εἴδη χυτοσίδηρου
 Y-laakeriyksiköt, valurautapesä
 Unidades de Rolamentos Y com chumaceira de ferro fundido
 Y-lejeenheder med støbejernshuse
 Y-lagerenheter med gjutna lagerus
 Y-lagerenheter med støpejernshus

Unit	Shaft	€	Housing	Bearing	€	End cover	€
TU 20 TF	20	***	TU 504 M	YAR 204-2F	28,92	ECY 204	***
TU 25 TF	25	65,50	TU 505 M	YAR 205-2F	33,43	ECY 205	***
TU 30 TF	30	79,64	TU 506 M	YAR 206-2F	40,79	ECY 206	***
TU 35 TF	35	93,36	TU 507 M	YAR 207-2F	49,37	ECY 207	***
TU 40 TF	40	109,91	TU 508 M	YAR 208-2F	59,04	ECY 208	***
TU 45 TF	45	***	TU 509 M	YAR 209-2F	65,83	ECY 209	***
TU 50 TF	50	139,32	TU 510 M	YAR 210-2F	74,74	ECY 210	***
TU 55 TF	55	***	TU 511 M	YAR 211-2F	97,00	ECY 211	***
TU 1. TF	25,4	***	TU 505 M	YAR 205-100-2F	33,43	ECY 205	***
TU 1.1/2 TF	38,1	***	TU 508 M	YAR 208-108-2F	***	ECY 208	***
TU 1.1/4 TF	31,75	***	TU 507 M	YAR 207-104-2F	***	ECY 207	***
TU 2. TF	50,8	***	TU 511 M	YAR 209-112-2F	***	ECY 209	***
TU 20 FM	20	***	TU 504 M	YET 204	33,86	ECY 204	***
TU 25 FM	25	***	TU 505 M	YET 205	36,59	ECY 205	***
TU 30 FM	30	***	TU 506 M	YET 206	43,75	ECY 206	***
TU 35 FM	35	***	TU 507 M	YET 207	53,34	ECY 207	***
TU 40 FM	40	***	TU 508 M	YET 208	64,53	ECY 208	***
TU 45 FM	45	***	TU 509 M	YET 209	77,11	ECY 209	***
TU 50 FM	50	***	TU 510 M	YET 210	83,33	ECY 210	***
TUJ 20 TF	20	***	TUJ 504	YAR 204-2F	28,92		
TUJ 25 TF		***	TUJ 505	YAR 205-2F	33,43		
TUJ 30 TF		***	TUJ 506	YAR 206-2F	40,79		
TUJ 35 TF	35	***	TUJ 507	YAR 207-2F	49,37		
TUJ 40 TF	40	***	TUJ 508	YAR 208-2F	59,04		
TUJ 45 TF	45	***	TUJ 509	YAR 209-2F	65,83		
TUJ 50 TF	50	***	TUJ 510	YAR 210-2F	74,74		
TUJ 55 TF	55	***	TUJ 511	YAR 211-2F	97,00		
TUJ 60 TF	60	***	TUJ 512	YAR 212-2F	129,66		

Έδρανα χυτοσίδηρου

Y-laakeriyksiköt, valurautapesä

Unidades de Rolamentos Y com chumaceira de ferro fundido

Y-lejeenheder med støbejernshuse

Y-lagerenheter med gjutna lagerus

Y-lagerenheter med stopejernshus

Y-bearing units with cast housing

Y-Lagereinheiten mit Gussgehäuse

Paliers Y avec corps en fonte

Sopporti Y con corpo in ghisa

Soportes de fundición con rodamientos Y

Y-lagereenheden met gietijzeren huizen

Unit	Shaft	€	Housing	Bearing	€	End cover	€
SYJ 25 KF		***	SYJ 505	YSA 205-2FK	***		
SYJ 30 KF		***	SYJ 506	YSA 206-2FK	***		
SYJ 35 KF	35	***	SYJ 507	YSA 207-2FK	***		
SYJ 40 KF		***	SYJ 508	YSA 208-2FK	***		
SYJ 45 KF	45	***	SYJ 509	YSA 209-2FK	65,83		
SYJ 50 KF		***	SYJ 510	YSA 210-2FK	***		
SYJ 55 KF		***	SYJ 511	YSA 211-2FK	97,00		
SYJ 60 KF		***	SYJ 512	YSA 212-2FK	***		
SYJ 65 KF	65	***	SYJ 513	YSA 213-2FK	149,44		
FYJ 25 KF		***	FYJ 505	YSA 205-2FK	***		
FYJ 30 KF	30	***	FYJ 506	YSA 206-2FK	***		
FYJ 35 KF		***	FYJ 507	YSA 207-2FK	***		
FYJ 40 KF	40	***	FYJ 508	YSA 208-2FK	***		
FYJ 45 KF	45	***	FYJ 509	YSA 209-2FK	65,83		
FYJ 50 KF		***	FYJ 510	YSA 210-2FK	***		
FYJ 55 KF		***	FYJ 511	YSA 211-2FK	97,00		
FYJ 60 KF		***	FYJ 512	YSA 212-2FK	***		
FYJ 65 KF	65	***	FYJ 513	YSA 213-2FK	149,44		
FYTJ 25 KF		***	FYTJ 505	YSA 205-2FK	***		
FYTJ 30 KF		***	FYTJ 506	YSA 206-2FK	***		
FYTJ 35 KF		***	FYTJ 507	YSA 207-2FK	***		
FYTJ 40 KF		***	FYTJ 508	YSA 208-2FK	***		
FYTJ 45 KF		***	FYTJ 509	YSA 209-2FK	65,83		
FYTJ 50 KF		***	FYTJ 510	YSA 210-2FK	***		

Y-bearing units with cast housing
 Y-Lagereinheiten mit Gussgehäuse
 Paliers Y avec corps en fonte
 Sopporti Y con corpo in ghisa
 Soportes de fundición con rodamientos Y
 Y-lagereenheden met gietijzeren huizen

Έδρανα χυτοσίδηρου
 Y-laakeriyksiköt, valurautapesä
 Unidades de Rolamentos Y com chumaceira de ferro fundido
 Y-lejeenheder med støbejernshuse
 Y-lagerenheter med gjutna lagerus
 Y-lagerenheter med støpejernshus

Unit	Shaft	€	Housing	Bearing	€	End cover	€
FYJ 100 TF	100	841,11	FYJ 520	YAR 220-2F	***		
FYJ 20 TF	20	***	FYJ 504	YAR 204-2F	28,92		
FYJ 25 TF	25	55,32	FYJ 505	YAR 205-2F	33,43		
FYJ 30 TF	30	66,65	FYJ 506	YAR 206-2F	40,79		
FYJ 35 TF	35	79,25	FYJ 507	YAR 207-2F	49,37		
FYJ 40 TF	40	91,57	FYJ 508	YAR 208-2F	59,04		
FYJ 45 TF	45	104,51	FYJ 509	YAR 209-2F	65,83		
FYJ 50 TF	50	122,20	FYJ 510	YAR 210-2F	74,74		
FYJ 55 TF	55	***	FYJ 511	YAR 211-2F	97,00		
FYJ 60 TF	60	201,98	FYJ 512	YAR 212-2F	129,66		
FYJ 65 TF	65	***	FYJ 513	YAR 213-2F	149,44		
FYJ 70 TF	70	372,11	FYJ 514	YAR 214-2F	226,73		
FYJ 75 TF	75	***	FYJ 515	YAR 215-2F	***		
FYJ 80 TF	80	523,23	FYJ 516	YAR 216-2F	348,78		
FYJ 90 TF	90	737,17	FYJ 518	YAR 218-2F	***		

Έδρανα με σύνθετο υλικό

Y-laakeriyksiköt, pesä materiaaliyhdistelmästä

Unidades de Rolamentos Y com chumaceira de material composto

Y-lejeenheder med kompositthuse

Y-lagerenheter med kompositthus

Y-lagerenheter med kompositthus

Y-bearing units with composite housing

Y-Lagereinheiten mit Verbundwerkstoffgehäuse

Paliers Y avec corps composite

Sopporti Y con corpo di composito

Soportes de material compuesto con rodamientos Y

Y-lagereenheden met composiet huizen

Unit	Shaft	€	Housing	Bearing	€	Adapter sleeve	€
SYFL 20 TH		***		YAR 204-2RF/HV	129,51		
SYFL 25 TH	25	***		YAR 205-2RF/HV	149,78		
SYFL 30 TH	30	***		YAR 206-2RF/HV	182,63		
SYFL 35 TH		***		YAR 207-2RF/HV	221,20		
SYFL 40 TH		***		YAR 208-2RF/HV	264,54		
SYFL 1.1/2 TH	38,1	***					
SYFL 1.1/4 TH	31,75	***					
SYFL 1.3/16 TH	30,16	***					
SYFL 3/4 TH	19,05	***					
SYFL 20 TR/VE495		***		YAR 204-2RF/VE495	***		
SYFL 25 TR/VE495		***		YAR 205-2RF/VE495	***		
SYFL 30 TR/VE495		***		YAR 206-2RF/VE495	***		
SYFL 35 TR/VE495		***		YAR 207-2RF/VE495	***		
SYFL 40 TR/VE495		***		YAR 208-2RF/VE495	***		

Y-bearing units with composite housing
Y-Lagereinheiten mit Verbundwerkstoffgehäuse
Paliers Y avec corps composite
Sopporti Y con corpo di composito
Soportes de material compuesto con rodamientos Y
Y-lagereenheden met composiet huizen

Εἶθρανα με σύνθετο υλικό
Y-laakeriyksiköt, pesä materiaaliyhdistelmästä
Unidades de Rolamentos Y com chumaceira de material composito
Y-lejeenheder med kompositthuse
Y-lagerenheter med kompositthus
Y-lagerenheter med kompositthus

Unit	Shaft	€	Housing	Bearing	€	Adapter sleeve	€
SYK 20 TF	20	***	SYK 504	YAR 204-2F	28,92	ECY 204	***
SYK 25 TF	25	***	SYK 505	YAR 205-2F	33,43	ECY 205	***
SYK 30 TF	30	***	SYK 506	YAR 206-2F	40,79	ECY 206	***
SYK 35 TF	35	***	SYK 507	YAR 207-2F	49,37	ECY 207	***
SYK 40 TF	40	***	SYK 508	YAR 208-2F	59,04	ECY 208	***
SYK 20 TR	20	***	SYK 504	YAR 204-2RF	32,39	ECY 204	***
SYK 25 TR	25	***	SYK 505	YAR 205-2RF	37,43	ECY 205	***
SYK 30 TR	30	***	SYK 506	YAR 206-2RF	45,65	ECY 206	***
SYK 35 TR	35	***	SYK 507	YAR 207-2RF	55,31	ECY 207	***
SYK 40 TR	40	***	SYK 508	YAR 208-2RF	66,14	ECY 208	***
SYKC 20 NTH		***	SYKC 504 N	YAR 204-2RF/HV	129,51		
SYKC 25 NTH	25	***	SYKC 505 N	YAR 205-2RF/HV	149,78		
SYKC 30 NTH		***	SYKC 506 N	YAR 206-2RF/HV	182,63		
SYKC 35 NTH		***	SYKC 507 N	YAR 207-2RF/HV	221,20		
SYKC 40 NTH		***	SYKC 508 N	YAR 208-2RF/HV	264,54		
SYL 20 TH	20	***		YAR 204-2RF/HV	129,51		
SYL 25 TH	25	***		YAR 205-2RF/HV	149,78		
SYL 30 TH	30	***		YAR 206-2RF/HV	182,63		
SYL 35 TH	35	***		YAR 207-2RF/HV	221,20		
SYL 40 TH	40	***		YAR 208-2RF/HV	264,54		
SYL 1. TH	25,4	***					
SYL 1.3/16 TH	30,16	***					
SYL 3/4 TH	25,4	***					
SYL 20 TR/VE495		***		YAR 204-2RF/VE495	***		
SYL 25 TR/VE495		***		YAR 205-2RF/VE495	***		
SYL 30 TR/VE495		***		YAR 206-2RF/VE495	***		
SYL 35 TR/VE495		***		YAR 207-2RF/VE495	***		
SYL 40 TR/VE495		***		YAR 208-2RF/VE495	***		

Έδρανα με σύνθετο υλικό

Y-laakeriyksiköt, pesä materiaaliyhdistelmästä

Unidades de Rolamentos Y com chumaceira de material composto

Y-lejeenheder med kompositthuse

Y-lagerenheter med kompositthus

Y-lagerenheter med kompositthus

Y-bearing units with composite housing

Y-Lagereinheiten mit Verbundwerkstoffgehäuse

Paliers Y avec corps composite

Supporti Y con corpo di composito

Soportes de material compuesto con rodamientos Y

Y-lageerheden met compositet huizen

Unit	Shaft	€	Housing	Bearing	€	Adapter sleeve	€
FYK 20 TF	20	***	FYK 504	YAR 204-2F	28,92	ECY 204	***
FYK 25 TF	25	***	FYK 505	YAR 205-2F	33,43	ECY 205	***
FYK 30 TF	30	***	FYK 506	YAR 206-2F	40,79	ECY 206	***
FYK 35 TF	35	***	FYK 507	YAR 207-2F	49,37	ECY 207	***
FYK 40 TF	40	***	FYK 508	YAR 208-2F	59,04	ECY 208	***
FYKC 20 NTH		***	FYKC 504 N	YAR 204-2RF/HV	129,51		
FYKC 25 NTH	25	***	FYKC 505 N	YAR 205-2RF/HV	149,78		
FYKC 30 NTH	30	209,81	FYKC 506 N	YAR 206-2RF/HV	182,63		
FYKC 35 NTH	35	***	FYKC 507 N	YAR 207-2RF/HV	221,20		
FYKC 40 NTH	40	***	FYKC 508 N	YAR 208-2RF/HV	264,54		
FYK 20 TR	20	***	FYK 504	YAR 204-2RF	32,39	ECY 204	***
FYK 25 TR	25	***	FYK 505	YAR 205-2RF	37,43	ECY 205	***
FYK 30 TR	30	***	FYK 506	YAR 206-2RF	45,65	ECY 206	***
FYK 35 TR	35	***	FYK 507	YAR 207-2RF	55,31	ECY 207	***
FYK 40 TR	40	***	FYK 508	YAR 208-2RF	66,14	ECY 208	***
FYTBKC 20 NTH	20	***	FYTBKC 504 N	YAR 204-2RF/HV	129,51		
FYTBKC 25 NTH	25	176,08	FYTBKC 505 N	YAR 205-2RF/HV	149,78		
FYTBKC 30 NTH	30	***	FYTBKC 506 N	YAR 206-2RF/HV	182,63		
FYTBKC 35 NTH	35	***	FYTBKC 507 N	YAR 207-2RF/HV	221,20		
FYTBK 20 TF	20	***	FYTBK 504	YAR 204-2F	28,92	ECY 204	***
FYTBK 25 TF	25	***	FYTBK 505	YAR 205-2F	33,43	ECY 205	***
FYTBK 30 TF	30	***	FYTBK 506	YAR 206-2F	40,79	ECY 206	***
FYTBK 35 TF	35	***	FYTBK 507	YAR 207-2F	49,37	ECY 207	***
FYTBK 20 TR	20	***	FYTBK 504	YAR 204-2RF	32,39	ECY 204	***
FYTBK 25 TR	25	***	FYTBK 505	YAR 205-2RF	37,43	ECY 205	***
FYTBK 30 TR	30	***	FYTBK 506	YAR 206-2RF	45,65	ECY 206	***
FYTBK 35 TR	35	***	FYTBK 507	YAR 207-2RF	55,31	ECY 207	***

Y-bearing units with composite housing
Y-Lagereinheiten mit Verbundwerkstoffgehäuse
Paliers Y avec corps composite
Sopporti Y con corpo di composito
Soportes de material compuesto con rodamientos Y
Y-lagereenheden met composiet huizen

Έδρανα με σύνθετο υλικό
Y-laakeryksiköt, pesä materiaaliyhdistelmästä
Unidades de Rolamentos Y com chumaceira de material composito
Y-lejeenheder med kompositthuse
Y-lagerenheter med kompositthus
Y-lagerenheter med kompositthus

Unit	Shaft	€	Housing	Bearing	€	Adapter sleeve	€
FYL 20 THR	20	***					
FYL 25 THR	25	***					
FYL 30 THR	30	***					
FYL 35 THR	35	***					
FYL 40 THR	40	***					
FYL 1.1/2 THR	38,1	***					
FYL 1.1/4 THR	31,75	***					
FYL 1.3/16 THR	30,16	***					
FYL 20 TR/VE495		***		YAR 204-2RF/VE495	***		
FYL 25 TR/VE495		***		YAR 205-2RF/VE495	***		
FYL 30 TR/VE495		***		YAR 206-2RF/VE495	***		
FYL 35 TR/VE495		***		YAR 207-2RF/VE495	***		
FYL 40 TR/VE495		***		YAR 208-2RF/VE495	***		
FYTL 20 THR	20	***					
FYTL 25 THR	25	***					
FYTL 30 THR	30	***					
FYTL 35 THR	35	***					
FYTL 40 THR	40	***					
FYTL 1. THR	25,4	***					
FYTL 1.1/2 THR	38,1	***					
FYTL 1.1/4 THR	31,75	***					
FYTL 1.3/16 THR	30,16	***					
FYTL 3/4 THR	19,05	***					
FYTL 20 TR/VE495		***		YAR 204-2RF/VE495	***		
FYTL 25 TR/VE495		***		YAR 205-2RF/VE495	***		
FYTL 30 TR/VE495		***		YAR 206-2RF/VE495	***		
FYTL 35 TR/VE495		***		YAR 207-2RF/VE495	***		
FYTL 40 TR/VE495		***		YAR 208-2RF/VE495	***		

Έδρανα με σύνθετο υλικό

Y-laakeriyksiköt, pesä materiaaliyhdistelmästä

Unidades de Rolamentos Y com chumaceira de material composto

Y-lejeenheder med kompositthuse

Y-lagerenheter med kompositthus

Y-lagerenheter med kompositthus

Y-bearing units with composite housing

Y-Lagereinheiten mit Verbundwerkstoffgehäuse

Paliers Y avec corps composite

Sopporti Y con corpo di composito

Soportes de material compuesto con rodamientos Y

Y-lagereenheden met composiet huizen

Unit	Shaft	€	Housing	Bearing	€	Adapter sleeve	€
TUL 20 TH	20	***		YAR 204-2RF/HV	129,51		
TUL 25 TH		***		YAR 205-2RF/HV	149,78		
TUL 30 TH	30	***		YAR 206-2RF/HV	182,63		
TUL 35 TH	35	***		YAR 207-2RF/HV	221,20		
TUL 40 TH	40	***		YAR 208-2RF/HV	264,54		
TUL 1.1/4 TH	31,75	***					
TUL 1.3/16 TH	30,16	***					
TUL 3/4 TH	19,05	***					
TUL 20 TR/VE495		***		YAR 204-2RF/VE495	***		
TUL 25 TR/VE495		***		YAR 205-2RF/VE495	***		
TUL 30 TR/VE495		***		YAR 206-2RF/VE495	***		
TUL 35 TR/VE495		***		YAR 207-2RF/VE495	***		
TUL 40 TR/VE495		***		YAR 208-2RF/VE495	***		

Y-bearing units with pressed housing
Y-Lagereinheiten mit Stahlblechgehäuse
Paliers Y avec corps en tôle
Sopporti Y con corpo di lamiera stampata
Soportes de chapa con rodamientos Y
Y-lagereenheden met staalplaat huizen

Έδρανα χυτοπ्रेसοαριστά
Y-laakeriyksiköt, teräslevyessä
Unidades de Rolamentos Y com chumaceiras prensadas
Y-lejeenheder med huse af presset stålplade
Y-lagerenheter med pressade lagerhus
Y-lagerenheter med pressede stålhus

Housing	€	Housing	€	Housing	€	Housing	€	Bearing	Shaft
P 40	6,76	PF 40	***	PFD 40	***	PFT 40	***	YET 203/15	15
P 40	6,76	PF 40	***	PFD 40	***	PFT 40	***	YET 203	17
P 47	7,52	PF 47	***	PFD 47	***	PFT 47	7,24	YET 204	20
P 52	7,84	PF 52	7,47	PFD 52	***	PFT 52	7,47	YET 205	25
P 62	***	PF 62	9,36	PFD 62	***	PFT 62	9,36	YET 206	30
P 72	***	PF 72	11,51	PFD 72	***	PFT 72	***	YET 207	35
P 80	***	PF 80	***			PFT 80	***	YAR 208-2F	40
P 85	***	PF 85	***					YAR 209-2F	45
		PF 90	***					YAR 210-2F	50
P 47	7,52	PF 47	***	PFD 47	***	PFT 47	7,24	YAR 204-2RF	20
P 52	7,84	PF 52	7,47	PFD 52	***	PFT 52	7,47	YAR 205-2RF	25
P 62	***	PF 62	9,36	PFD 62	***	PFT 62	9,36	YAR 206-2RF	30
P 72	***	PF 72	11,51	PFD 72	***	PFT 72	***	YAR 207-2RF	35
P 80	***	PF 80	***			PFT 80	***	YAR 208-2RF	40
P 85	***	PF 85	***					YAR 209-2RF	45
		PF 90	***					YET 210	50
P 40	6,76	PF 40	***	PFD 40	***	PFT 40	***	YAT 203	17
P 47	7,52	PF 47	***	PFD 47	***	PFT 47	7,24	YAT 204	20
P 52	7,84	PF 52	7,47	PFD 52	***	PFT 52	7,47	YAT 205	25
P 62	***	PF 62	9,36	PFD 62	***	PFT 62	9,36	YAT 206	30
P 72	***	PF 72	11,51	PFD 72	***	PFT 72	***	YAT 207	35
P 80	***	PF 80	***			PFT 80	***	YAT 208	40
P 85	***	PF 85	***					YAT 209	45
		PF 90	***					YAT 210	50
P 40	6,76	PF 40	***	PFD 40	***	PFT 40	***	YAR 203/12-2F	12
P 40	6,76	PF 40	***	PFD 40	***	PFT 40	***	YAR 203/15-2F	15
P 40	6,76	PF 40	***	PFD 40	***	PFT 40	***	YAR 203-2F	17
P 47	7,52	PF 47	***	PFD 47	***	PFT 47	7,24	YAR 204-2RF	20
P 52	7,84	PF 52	7,47	PFD 52	***	PFT 52	7,47	YAR 205-2RF	25
P 62	***	PF 62	9,36	PFD 62	***	PFT 62	9,36	YAR 206-2RF	30
P 72	***	PF 72	11,51	PFD 72	***	PFT 72	***	YAR 207-2RF	35
P 80	***	PF 80	***			PFT 80	***	YAR 208-2RF	40
P 85	***	PF 85	***					YAR 209-2RF	45
		PF 90	***					YAR 210-2RF	50

Έδρανα ConCentra

SKF ConCentra

SKF ConCentra

SKF ConCentra lejeenheder

SKF ConCentra

SKF ConCentra

SKF ConCentra

SKF ConCentra-Rollenlagereinheiten

SKF ConCentra

SKF ConCentra

SKF ConCentra

SKF ConCentra

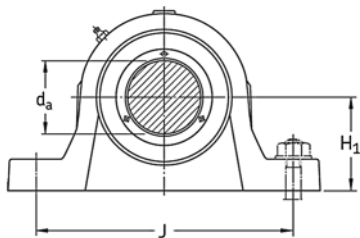

SYNT .. F	108
SYNT .. FTS	108
SYNT .. L	108
SYNT .. LTS	108

SY	108
FY	108

	€	d _a	H ₁	J	min		€	d _a	H ₁	J	min
						SY 45 PF	***				
SYNT 35 F	***					SY 30 PF	***	30	152	53,1	
SYNT 40 F	327,98					SY 35 PF	***	35	160	54,3	
SYNT 45 F	***					SY 40 PF	113,66	40	175	56,7	
SYNT 50 F	427,43										
SYNT 55 F	496,20										
						FY 35 PF	***	35	118	53	
SYNT 60 F	539,58					FY 40 PF	***	40	1300	57,2	
SYNT 65 F	***								00		
SYNT 70 F	***										
SYNT 75 F	***										
SYNT 60 FTS	***										
SYNT 35 L	***										
SYNT 40 L	327,98										
SYNT 45 L	352,31										
SYNT 50 L	427,43										
SYNT 55 L	496,20										
SYNT 60 L	539,58										
SYNT 65 L	***										
SYNT 70 L	779,75										
SYNT 75 L	***										
SYNT 35 LTS	***										
SYNT 40 LTS	***										
SYNT 60 LTS	***										
SYNT 70 LTS	***										

Έδρανα
 Laakeripesät
 Chumaceiras
 Lejehuse
 Lagerhus
 Lagerhus

Housings
 Lagergehäuse
 Paliers
 Sopporti
 Soportes
 Lagerhuizen

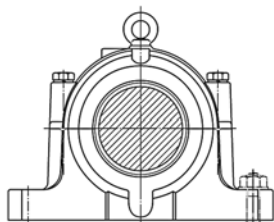

SNLN 30 112

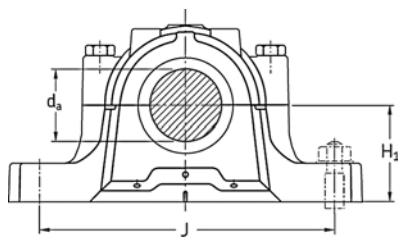

SNL 112
 FSNL 112
 SSNLD 112

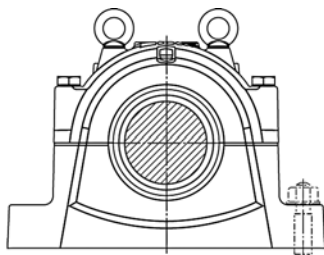

SNL 31 112

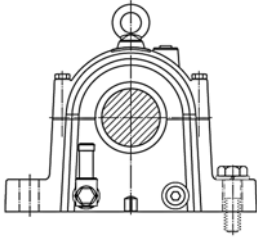

SONL 112

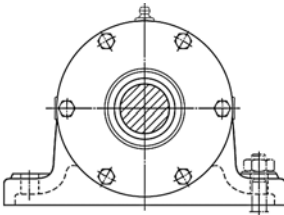

PDL 112

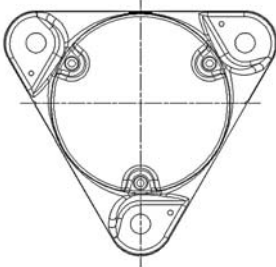

FNL .. A 112

Έδρανα
Laakeripesät
Chumaceiras
Lejehuse
Lagerhus
Lagerhus

Housings
Lagergehäuse
Paliers
Sopporti
Soportes
Lagerhuizen

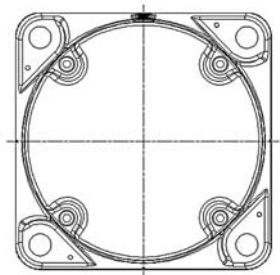

FNL .. B 113

ASNH 114
TS 114
TSN .. A 114
TSN .. C 115
TSN .. L 115
TSN .. S 115
FRB 116

	€		€
SNLN 3034	***	SNL 532	1780,52
SNL 205	***	FSNL 524-620	***
SNL 206-305	***		
SNL 207	***		
SNL 208-307	132,39		
SNL 209	128,63		
SNL 210	129,14	SSNLD 511-609	***
SNL 211	***	SSNLD 513-611	***
SNL 212	179,14	SSNLD 515-612	***
SNL 213	***	SSNLD 516-613	***
SNL 215	238,31	SSNLD 519-616	***
SNL 216	288,19	SSNLD 520-617	***
SNL 217	***	SSNLD 522-619	***
SNL 218	350,17	SSNLD 524-620	***
SNL 505	131,50	SSNLD 528	***
SNL 506-605	139,10	SSNLD 530	***
SNL 507-606	103,08	SSNLD 532	***
SNL 508-607	103,21		
SNL 509	109,09		
SNL 509 V	***		
SNL 510-608	117,40		
SNL 511-609	164,74	SNL 3134	2654,64
SNL 511-609 V	***	SNL 3136	3087,85
SNL 512-610	179,14	SNL 3138	***
SNL 513-611	209,19	SNL 3140	***
SNL 513-611 V	***		
SNL 515-612	222,37	SONL 228-528	***
SNL 515-612 V	***		
SNL 516-613	278,97		
SNL 516-613 V	***		
SNL 517	308,21		
SNL 518-615	350,17	PDN 310	***
SNL 518-615 V	***	PDN 311	***
SNL 519-616	404,69	PDN 312	***
SNL 520-617	455,95	PDN 314	***
SNL 522-619	619,16		
SNL 522-619 V	***	FNL 506 A	***
SNL 524-620	727,60	FNL 507 A	***
SNL 526	957,71	FNL 508 A	***
SNL 528	1158,16	FNL 509 A	235,42
SNL 530	1423,92	FNL 510 A	***

Έδρανα
 Laakeripesät
 Chumaceiras
 Lejehuse
 Lagerhus
 Lagerhus

Housings
 Lagergehäuse
 Paliers
 Sopporti
 Soportes
 Lagerhuizen

	€			€
FNL 511 A	380,40			
FNL 512 A	***			
FNL 513 A	409,23			
FNL 515 A	451,45			
FNL 516 A	469,22			
FNL 518 A	604,22			
FNL 520 A	***			
FNL 522 A	***			
FNL 506 B	***			
FNL 507 B	197,29			
FNL 508 B	***			
FNL 509 B	235,42			
FNL 510 B	288,75			
FNL 511 B	380,40			
FNL 512 B	386,86			
FNL 513 B	409,23			
FNL 515 B	451,64			
FNL 516 B	492,71			
FNL 517 B	***			
FNL 518 B	632,16			
FNL 520 B	***			
FNL 522 B	***			

	€			€
ASNH 216	***		TS 34	***
ASNH 217	***		TS 36	219,14
ASNH 218	***		TS 38	***
ASNH 505	***		TS 40	***
ASNH 506-605	***		TS 44	***
ASNH 507-606	***		TS 48	***
ASNH 508-607	***		TS 52	***
ASNH 509	***		TS 56	***
ASNH 510-608	***		TS 60	***
ASNH 511-609	***			
ASNH 512-610	***		TSN 208 A	***
ASNH 513-611	***		TSN 210 A	***
ASNH 515-612	***		TSN 212 A	***
ASNH 516-613	***		TSN 213 A	***
ASNH 517	***		TSN 215 A	***
ASNH 518-615	***		TSN 216 A	***
ASNH 519-616	***		TSN 217 A	***
ASNH 520-617	***		TSN 218 A	***
ASNH 522-619	***		TSN 220 A	***
ASNH 524-620	***		TSN 222 A	***
ASNH 526	***		TSN 224 A	***
ASNH 528	***		TSN 226 A	***
ASNH 530	***		TSN 228 A	***
ASNH 532	***		TSN 230 A	***
			TSN 232 A	***
			TSN 308 A	***
			TSN 309 A	***
			TSN 310 A	***
			TSN 311 A	***
			TSN 312 A	***
			TSN 313 A	***
			TSN 314 A	***
			TSN 315 A	***
			TSN 316 A	***
			TSN 317 A	***
			TSN 319 A	***
			TSN 320 A	***
			TSN 505 A	***
			TSN 506 A	***
			TSN 507 A	***
			TSN 508 A	***
			TSN 509 A	35,60
			TSN 510 A	36,29
			TSN 511 A	40,70
			TSN 512 A	***

	€			€
TSN 513 A	48,67		TSN 507 L	19,68
TSN 515 A	53,56		TSN 508 L	21,75
TSN 516 A	55,59		TSN 509 L	17,80
TSN 517 A	58,01		TSN 510 L	18,97
TSN 518 A	64,38		TSN 511 L	24,14
TSN 519 A	***		TSN 609 L	27,59
TSN 520 A	67,46		TSN 610 L	20,22
TSN 522 A	72,45		TSN 611 L	21,30
TSN 524 A	87,39		TSN 515 L	27,92
TSN 526 A	***		TSN 516 L	30,86
TSN 528 A	***		TSN 517 L	33,30
TSN 530 A	***		TSN 518 L	38,36
TSN 532 A	***		TSN 519 L	***
TSN 606 A	***		TSN 520 L	55,70
TSN 607 A	***		TSN 220 L	65,73
TSN 608 A	***		TSN 522 L	60,74
TSN 609 A	***		TSN 222 L	71,03
TSN 610 A	***		TSN 224 L	83,68
TSN 611 A	***		TSN 524 L	49,06
TSN 612 A	***		TSN 526 L	64,56
TSN 613 A	***		TSN 528 L	70,47
TSN 615 A	***		TSN 530 L	***
TSN 616 A	***		TSN 532 L	82,76
TSN 617 A	***		TSN 512 L	21,93
TSN 619 A	***		TSN 513 L	22,73
TSN 620 A	***		TSN 226 L	***
TSN 509 C	18,63		TSN 507 S	***
TSN 510 C	***		TSN 509 S	***
TSN 511 C	22,69		TSN 510 S	***
TSN 512 C	***		TSN 511 S	***
TSN 513 C	26,33		TSN 512 S	***
TSN 611 C	***		TSN 513 S	126,75
TSN 515 C	30,30		TSN 515 S	***
TSN 613 C	***		TSN 516 S	***
TSN 516 C	32,69		TSN 517 S	***
TSN 517 C	35,16		TSN 518 S	***
TSN 518 C	37,77		TSN 520 S	***
TSN 520 C	84,05		TSN 522 S	***
TSN 524 C	89,14		TSN 524 S	***
TSN 528 C	***		TSN 526 S	***
TSN 612 L	***		TSN 528 S	***
TSN 613 L	23,81		TSN 530 S	***
TSN 615 L	***		TSN 532 S	***
TSN 616 L	37,03			
TSN 617 L	***			

	€			€	
FRB 10.5/110	***		FRB 17.5/160	***	
FRB 10.5/80	***		FRB 17.5/200	***	
FRB 10.5/90	***		FRB 17/290	***	
FRB 10/110	9,34		FRB 18/170	***	
FRB 10/120	9,34		FRB 18/180	***	
FRB 10/130	***		FRB 19.5/215	***	
FRB 10/140	***		FRB 2/120	***	
FRB 10/150	***		FRB 21/200	***	
FRB 10/160	***		FRB 22/215	***	
FRB 10/180	***		FRB 3.5/52	***	
FRB 10/200	***		FRB 3.5/72	***	
FRB 10/280	***		FRB 3.5/85	7,16	
FRB 10/290	***		FRB 4.85/180	***	
FRB 10/300	***		FRB 4/100	***	
FRB 10/310	***		FRB 4/110	***	
FRB 10/320	***		FRB 4/120	***	
FRB 10/340	***		FRB 4/80	***	
FRB 10/370	***		FRB 4/90	***	
FRB 10/400	***		FRB 5.1/200	***	
FRB 10/440	***		FRB 5.5/72	***	
FRB 10/460	***		FRB 5.5/85	***	
FRB 11.2/160	***		FRB 5/130	***	
FRB 11.5/100	***		FRB 5/140	***	
FRB 11/120	***		FRB 5/150	***	
FRB 12.5/130	14,72		FRB 5/160	***	
FRB 12.5/140	14,72		FRB 5/170	***	
FRB 12.5/150	14,39		FRB 5/180	***	
FRB 12.5/160	15,53		FRB 5/215	***	
FRB 12.5/170	***		FRB 5/230	***	
FRB 12.5/200	***		FRB 5/250	***	
FRB 12/180	21,27		FRB 5/270	***	
FRB 13.5/200	34,43		FRB 5/290	***	
FRB 13/110	***		FRB 5/52	***	
FRB 13/150	***		FRB 6.25/160	***	
FRB 13/230	***		FRB 6.5/200	***	
FRB 14.5/170	***		FRB 6.5/215	***	
FRB 14.5/180	***		FRB 6/100	***	
FRB 14/120	***		FRB 6/62	***	
FRB 14/160	***		FRB 6/85	***	
FRB 14/215	30,26		FRB 7.5/62	***	
FRB 15.5/130	***		FRB 7.5/72	***	
FRB 15/250	***		FRB 7/80	***	
FRB 16.5/150	***		FRB 8.5/140	***	
FRB 16.5/270	***		FRB 8.5/72	***	
FRB 16/140	***		FRB 8/110	***	

Έδρανα
Laakeripesät
Chumaceiras
Lejehuse
Lagerhus
Lagerhus

Housings
Lagergehäuse
Paliers
Sopporti
Soportes
Lagerhuizen

	€			€
FRB 8/130	***			
FRB 8/62	***			
FRB 8/72	***			
FRB 8/80	***			
FRB 9.5/100	9,17			
FRB 9/80	***			
FRB 9/90	8,75			

Housing Έδρανο	Gehäuse Corps de paliers Corpo Soporte Huis	Pesä Chumaceiras Hus Hus Hus
Double-lip seals Δίχειλες σιμούχες	Zweilippendichtungen Joints à deux lèvres Tenute a doppio labbro Retenes de doble labio Dubbellip afdichtingen	2-huulitiivisteet Vedantes de lábio duplo Dobbeltlæbetætning Tvåläppstätningar Dobbeltleppetætninger
V-ring seals Σιμούχες τύπου V	V-Ringdichtungen Joints V-Ring V-ring Retenes anillos en V V-ring afdichtingen	V-renkaat V-rings V-ringstætninger V-ringstätningar V-ring tetninger
Bearing Ρουλεμάν	Lager Roulement Cuscinetto Rodamiento Lager	Laakeri Rolamento Leje Lager Lager
Adapter sleeve Σφιγκτήρας άρμωσης	Spannhülse Manchon de serrage Bussola di trazione Manguito de fijación Trekbus	Kiristysholkki Casquilhos Klembøsning Klämhylsa Klemhylse
Locating ring Ασφάλεια	Festringe Bague d'arrêt Anello di arresto Anillo de fijación Stelring	Ohjausrengas Aneis de bloqueio Styrering Styrring Styrering
End cover Καπάκι	Abschlussdeckel Couvercle Coperchio di estremità Tapa lateral Einddeksel	Päätykansi Tampa Endedæksel Ändlock Endelokk

Housings
Lagergehäuse
Paliers
Soporti
Soportes
Lagerhuizen

Έδρανα
Laakeripesät
Chumaceiras
Lejehuse
Lagerhus
Lagerhus

Labyrinth ring with O-section silicone tube
Λαβύρινθος με O-ring

Labyrintring mit O-ring
Collerette à chicane avec cordon silicone
Labirinto con O-ring cavo in silicone
Obturación de laberinto con junta de silicona
Labyrintring met O-ring
Sokkelorengas, jossa O-rengas silikonitiivisteellä
Vedante de labirinto com junta de silicone
Labyrinttætning med hul silikone O-ring
Labyrintring med silikongummisnöre
Labyrintring med silikon O-ring

End cover with O-section silicone tube
Καπάκι με O-ring

Enddeckel mit O-ring
Disque d'obturation avec cordon silicone
Coperchio di estremità con O-ring cavo in silicone
Tapa lateral con junta de silicona
Einddeksel met O-ring
Päätykansi, jossa O-rengas silikonitiivisteellä
Tampa com junta de silicone
Endedæksel med hul silikone O-ring
Ändlock med silikongummisnöre
Endelokk med silikon O-ring (ETS)

SNL assembly table
Auswahl-Tabelle SNL-Gehäuse, Lager und Zubehör
Tableau des composants pour paliers SNL
Tabella di composizione dei sopporti SNL
Tabla de componentes para soportes SNL
Samenstelling complete SNL lagerhuizen

Πίνακας εδράνων SNL
SNL valintaulukko
SNL-tabela de conjuntos
SNL-lejehuse og tilbehør
Kompletta SNL stålagerhus
Komplette SNL-lagerhus

d ₃	H ₁	J	Housing	€	Double-lip seals	€	V-ring seals	€
40		130	SNL 505	131,50	TSN 505 G	***	TSN 505 A	28,21
40		130	SNL 505	131,50	TSN 505 G	***	TSN 505 A	28,21
50		150	SNL 506-605	139,10	TSN 506 G	***	TSN 506 A	29,30
50		150	SNL 506-605	139,10	TSN 506 G	***	TSN 506 A	29,30
50		150	SNL 506-605	139,10	TSN 605 G	***	TSN 605 A	***
50		150	SNL 507-606	103,08	TSN 606 G	***	TSN 606 A	26,93
50		150	SNL 507-606	103,08	TSN 606 G	***	TSN 606 A	26,93
60		170	SNL 508-607	103,21	TSN 607 G	***	TSN 607 A	29,45
60		170	SNL 508-607	103,21	TSN 607 G	***	TSN 607 A	29,45
60		170	SNL 510-608	117,40	TSN 608 G	***	TSN 608 A	35,59
60		170	SNL 510-608	117,40	TSN 608 G	***	TSN 608 A	35,59
60		170	SNL 510-608	117,40	TSN 608 G	***	TSN 608 A	35,59
70		210	SNL 511-609	164,74	TSN 609 G	***	TSN 609 A	35,53
70		210	SNL 511-609	164,74	TSN 609 G	***	TSN 609 A	35,53
70		210	SNL 511-609	164,74	TSN 609 G	***	TSN 609 A	35,53
70		210	SNL 511-609	164,74	TSN 609 G	***	TSN 609 A	35,53
70		210	SNL 512-610	179,14	TSN 610 G	***	TSN 610 A	39,53
70		210	SNL 512-610	179,14	TSN 610 G	***	TSN 610 A	39,53
70		210	SNL 512-610	179,14	TSN 610 G	***	TSN 610 A	39,53
70		210	SNL 512-610	179,14	TSN 610 G	***	TSN 610 A	39,53
80		230	SNL 513-611	209,19	TSN 611 G	***	TSN 611 A	39,82
80		230	SNL 513-611	209,19	TSN 611 G	***	TSN 611 A	39,82
80		230	SNL 513-611	209,19	TSN 611 G	***	TSN 611 A	39,82
80		230	SNL 513-611	209,19	TSN 611 G	***	TSN 611 A	39,82
80		230	SNL 515-612	222,37	TSN 612 G	***	TSN 612 A	47,75
80		230	SNL 515-612	222,37	TSN 612 G	***	TSN 612 A	47,75
80		230	SNL 515-612	222,37	TSN 612 G	***	TSN 612 A	47,75
80		230	SNL 515-612	222,37	TSN 612 G	***	TSN 612 A	47,75
95		260	SNL 516-613	278,97	TSN 613 G	***	TSN 613 A	47,92
95		260	SNL 516-613	278,97	TSN 613 G	***	TSN 613 A	47,92
95		260	SNL 516-613	278,97	TSN 613 G	***	TSN 613 A	47,92
95		260	SNL 516-613	278,97	TSN 613 G	***	TSN 613 A	47,92
100		290	SNL 518-615	350,17	TSN 615 G	***	TSN 615 A	50,96
100		290	SNL 518-615	350,17	TSN 615 G	***	TSN 615 A	50,96
100		290	SNL 518-615	350,17	TSN 615 G	***	TSN 615 A	50,96
100		290	SNL 518-615	350,17	TSN 615 G	***	TSN 615 A	50,96
112		290	SNL 519-616	404,69	TSN 616 G	***	TSN 616 A	68,84
112		290	SNL 519-616	404,69	TSN 616 G	***	TSN 616 A	68,84
112		290	SNL 519-616	404,69	TSN 616 G	***	TSN 616 A	68,84
112		290	SNL 519-616	404,69	TSN 616 G	***	TSN 616 A	68,84
112		320	SNL 520-617	455,95	TSN 617 G	***	TSN 617 A	73,15
112		320	SNL 520-617	455,95	TSN 617 G	***	TSN 617 A	73,15

Πίνακας εδράνων SNL
SNL valintataulukko
SNL-tabela de conjuntos
SNL-lejehuse og tilbehør
Kompletta SNL stålagerhus
Komplette SNL-lagerhus

SNL assembly table
Auswahl-Tabelle SNL-Gehäuse, Lager und Zubehör
Tableau des composants pour paliers SNL
Tabella di composizione dei sopporti SNL
Tabla de componentes para soportes SNL
Samenstelling complete SNL lagerhuizen

Bearing	€	Adapter sleeve	€	Locating ring	€	End cover	€
1205 EKTN9/C3	37,34	H 205	21,83	FRB 5/52	5,64	ASNH 505	7,59
2205 EKTN9/C3	50,20	H 305	22,49	FRB 3.5/52	4,97	ASNH 505	7,59
1206 EKTN9/C3	43,28	H 206	22,07	FRB 8/62	6,41	ASNH 506-605	7,59
2206 EKTN9/C3	54,21	H 306	22,60	FRB 6/62	6,78	ASNH 506-605	7,59
1305 EKTN9	54,18	H 305	22,49	FRB 7.5/62	6,62	ASNH 506-605	7,59
1306 EKTN9/C3	66,99	H 306	22,60	FRB 7.5/72	7,94	ASNH 507-606	7,87
2306 K/C3	91,86	H 2306	34,27	FRB 3.5/72	10,20	ASNH 507-606	7,87
1307 EKTN9/C3	76,81	H 307	24,94	FRB 9/80	7,94	ASNH 508-607	8,79
2307 EKTN9/C3	105,46	H 2307	34,17	FRB 4/80	7,94	ASNH 508-607	8,79
1308 EKTN9/C3	94,70	H 308	26,83	FRB 9/90	8,75	ASNH 510-608	9,25
2308 EKTN9/C3	125,47	H 2308	34,49	FRB 4/90	7,94	ASNH 510-608	9,25
22308 EK	198,33	H 2308	34,49	FRB 4/90	7,94	ASNH 510-608	9,25
1309 EKTN9/C3	113,84	H 309	31,03	FRB 9.5/100	9,17	ASNH 511-609	9,29
2309 EKTN9/C3	156,19	H 2309	39,95	FRB 4/100	8,84	ASNH 511-609	9,29
21309 EK	203,05	H 309	31,03	FRB 9.5/100	9,17	ASNH 511-609	9,29
22309 EK	222,66	H 2309	39,95	FRB 4/100	8,84	ASNH 511-609	9,29
1310 EKTN9/C3	141,19	H 310	35,13	FRB 10.5/110	10,14	ASNH 512-610	10,03
2310 K/C3	201,54	H 2310	42,83	FRB 4/110	9,70	ASNH 512-610	10,03
21310 EK	233,45	H 310	35,13	FRB 10.5/110	10,14	ASNH 512-610	10,03
22310 EK	261,34	H 310	35,13	FRB 4/110	9,70	ASNH 512-610	10,03
1311 EKTN9/C3	168,26	H 311	36,70	FRB 11/120	11,65	ASNH 513-611	9,85
2311 K/C3	249,11	H 2311	46,89	FRB 4/120	9,04	ASNH 513-611	9,85
21311 EK	268,07	H 311	36,70	FRB 11/120	11,65	ASNH 513-611	9,85
22311 EK	306,84	H 2311	46,89	FRB 4/120	9,04	ASNH 513-611	9,85
1312 EKTN9/C3	211,41	H 312	38,94	FRB 12.5/130	14,72	ASNH 515-612	12,17
2312 K/C3	307,75	H 2312	62,47	FRB 5/130	9,70	ASNH 515-612	12,17
21312 EK	308,27	H 312	38,94	FRB 12.5/130	14,72	ASNH 515-612	12,17
22312 EK	356,13	H 2312	62,47	FRB 5/130	9,70	ASNH 515-612	12,17
1313 EKTN9/C3	259,89	H 313	43,43	FRB 12.5/140	14,72	ASNH 516-613	12,73
2313 K/C3	371,05	H 2313	71,64	FRB 5/140	10,34	ASNH 516-613	12,73
21313 EK	354,82	H 313	43,43	FRB 12.5/140	14,72	ASNH 516-613	12,73
22313 EK	414,12	H 2313	71,64	FRB 5/140	10,34	ASNH 516-613	12,73
1315 K/C3	387,09	H 315	75,13	FRB 14/160	18,21	ASNH 518-615	13,05
2315 K/C3	579,95	H 2315	97,09	FRB 5/160	15,94	ASNH 518-615	13,05
21315 EK	465,50	H 315	75,13	FRB 14/160	18,21	ASNH 518-615	13,05
22315 EK	554,44	H 2315	97,09	FRB 5/160	15,94	ASNH 518-615	13,05
1316 K/C3	439,04	H 316	91,75	FRB 14.5/170	24,28	ASNH 519-616	21,31
2316 K/C3	705,18	H 2316	115,99	FRB 5/170	16,81	ASNH 519-616	21,31
21316 EK	524,18	H 316	91,75	FRB 14.5/170	24,28	ASNH 519-616	21,31
22316 EK	628,62	H 2316	115,99	FRB 5/170	16,81	ASNH 519-616	21,31
1317 K/C3	573,94	H 317	105,17	FRB 14.5/180	26,41	ASNH 520-617	21,22
2317 KM/C3	1126,19	H 2317	123,61	FRB 5/180	18,21	ASNH 520-617	21,22

SNL assembly table
Auswahl-Tabelle SNL-Gehäuse, Lager und Zubehör
Tableau des composants pour paliers SNL
Tabella di composizione dei sopporti SNL
Tabla de componentes para soportes SNL
Samenstelling complete SNL lagerhuizen

Πίνακας εδράνων SNL
SNL valintataulukko
SNL-tabela de conjuntos
SNL-lejehuse og tilbehør
Kompletta SNL stålagerhus
Komplette SNL-lagerhus

d ₃	H ₁	J	Housing	€	Double-lip seals	€	V-ring seals	€
112		320	SNL 520-617	455,95	TSN 617 G	***	TSN 617 A	73,15
112		320	SNL 520-617	455,95	TSN 617 G	***	TSN 617 A	73,15
125		350	SNL 522-619	619,16	TSN 619 G	***	TSN 619 A	78,56
140		350	SNL 524-620	727,60	TSN 620 G	***	TSN 620 A	94,72
140		350	SNL 524-620	727,60	TSN 524 G	***	TSN 524 A	87,39
140		350	SNL 524-620	727,60	TSN 524 G	***	TSN 524 A	87,39
150		380	SNL 526	957,71	TSN 526 G	***	TSN 526 A	101,97
150		380	SNL 526	957,71	TSN 526 G	***	TSN 526 A	101,97
150		420	SNL 528	1158,16	TSN 528 G	***	TSN 528 A	117,67
150		420	SNL 528	1158,16	TSN 528 G	***	TSN 528 A	117,67
160		450	SNL 530	1423,92	TSN 530 G	***	TSN 530 A	153,75
160		450	SNL 530	1423,92	TSN 530 G	***	TSN 530 A	153,75
170		470	SNL 532	1780,52	TSN 532 G	***	TSN 532 A	169,20
170		470	SNL 532	1780,52	TSN 532 G	***	TSN 532 A	169,20
29	50	150	SNL 507-606	103,08	TSN 507 L	19,68	TSN 507 A	32,87
29	50	150	SNL 507-606	103,08	TSN 507 L	19,68	TSN 507 A	32,87
34	60	170	SNL 508-607	103,21	TSN 508 L	21,75	TSN 508 A	28,85
34	60	170	SNL 508-607	103,21	TSN 508 L	21,75	TSN 508 A	28,85
34	60	170	SNL 508-607	103,21	TSN 508 L	21,75	TSN 508 A	28,85
39	60	170	SNL 509	109,09	TSN 509 L	17,80	TSN 509 A	35,60
39	60	170	SNL 509	109,09	TSN 509 L	17,80	TSN 509 A	35,60
44	60	170	SNL 510-608	117,40	TSN 510 L	18,97	TSN 510 A	36,29
44	60	170	SNL 510-608	117,40	TSN 510 L	18,97	TSN 510 A	36,29
49	70	210	SNL 511-609	164,74	TSN 511 L	24,14	TSN 511 A	40,70
49	70	210	SNL 511-609	164,74	TSN 511 L	24,14	TSN 511 A	40,70
49	70	210	SNL 511-609	164,74	TSN 511 L	24,14	TSN 511 A	40,70
58.5	80	230	SNL 513-611	209,19	TSN 513 L	22,73	TSN 513 A	48,67
58.5	80	230	SNL 513-611	209,19	TSN 513 L	22,73	TSN 513 A	48,67
58.5	80	230	SNL 513-611	209,19	TSN 513 L	22,73	TSN 513 A	48,67
63	80	230	SNL 515-612	222,37	TSN 515 L	27,92	TSN 515 A	53,56
63	80	230	SNL 515-612	222,37	TSN 515 L	27,92	TSN 515 A	53,56
63	80	230	SNL 515-612	222,37	TSN 515 L	27,92	TSN 515 A	53,56
68	95	260	SNL 516-613	278,97	TSN 516 L	30,86	TSN 516 A	55,59
68	95	260	SNL 516-613	278,97	TSN 516 L	30,86	TSN 516 A	55,59
68	95	260	SNL 516-613	278,97	TSN 516 L	30,86	TSN 516 A	55,59
73	95	260	SNL 517	308,21	TSN 517 L	33,30	TSN 517 A	58,01
73	95	260	SNL 517	308,21	TSN 517 L	33,30	TSN 517 A	58,01
73	95	260	SNL 517	308,21	TSN 517 L	33,30	TSN 517 A	58,01

Πίνακας εδράνων SNL
SNL valintataulukko
SNL-tabela de conjuntos
SNL-lejehuse og tilbehør
Kompletta SNL stålagerhus
Komplette SNL-lagerhus

SNL assembly table
Auswahl-Tabelle SNL-Gehäuse, Lager und Zubehör
Tableau des composants pour paliers SNL
Tabella di composizione dei sopporti SNL
Tabla de componentes para soportes SNL
Samenstelling complete SNL lagerhuizen

Bearing	€	Adapter sleeve	€	Locating ring	€	End cover	€
21317 EK	577,48	H 317	105,17	FRB 14.5/180	26,41	ASNH 520-617	21,22
22317 EK	731,99	H 2317	123,61	FRB 5/180	18,21	ASNH 520-617	21,22
22319 EK	984,99	H 2319	191,25	FRB 6.5/200	23,05	ASNH 522-619	25,47
22320 EK	1182,21	H 2320	208,99	FRB 6.5/215	26,21	ASNH 524-620	33,74
22224 EK	951,68	H 3124	230,70	FRB 14/215	30,26	ASNH 524-620	33,74
23224 CCK/W33	1292,07	H 2324	334,50	FRB 5/215	22,24	ASNH 524-620	33,74
22226 EK	1126,32	H 3126	298,58	FRB 13/230	35,29	ASNH 526	36,74
23226 CCK/W33	1539,65	H 2326	453,27	FRB 5/230	27,98	ASNH 526	36,74
22228 CCK/W33	1420,86	H 3128	384,73	FRB 15/250	43,65	ASNH 528	49,94
23228 CCK/W33	1918,27	H 2328	533,11	FRB 5/250	31,20	ASNH 528	49,94
22230 CCK/W33	1775,78	H 3130	531,31	FRB 16.5/270	65,90	ASNH 530	52,64
23230 CCK/W33	2487,38	H 2330	690,15	FRB 5/270	45,77	ASNH 530	52,64
22232 CCK/W33	2210,42	H 3132	621,53	FRB 17/290	87,66	ASNH 532	70,30
23232 CCK/W33	2952,20	H 2332	773,74	FRB 5/290	60,45	ASNH 532	70,30
1207 EKTN9/C3	46,89	H 207	23,29	FRB 8.5/72	7,94	ASNH 507-606	7,87
2207 EKTN9/C3	63,08	H 307	24,94	FRB 5.5/72	8,44	ASNH 507-606	7,87
1208 EKTN9/C3	58,37	H 208	24,64	FRB 10.5/80	7,94	ASNH 508-607	8,79
2208 EKTN9/C3	71,97	H 308	26,83	FRB 8/80	7,38	ASNH 508-607	8,79
22208 EK	139,08	H 308	26,83	FRB 8/80	7,38	ASNH 508-607	8,79
1209 EKTN9/C3	61,71	H 209	30,26	FRB 5.5/85	7,38	ASNH 509	9,15
2209 EKTN9/C3	79,15	H 309	31,03	FRB 3.5/85	7,16	ASNH 509	9,15
1210 EKTN9/C3	72,89	H 210	32,41	FRB 10.5/90	9,04	ASNH 510-608	9,25
2210 EKTN9/C3	94,50	H 310	35,13	FRB 9/90	8,75	ASNH 510-608	9,25
1211 EKTN9/C3	86,64	H 211	35,13	FRB 11.5/100	9,46	ASNH 511-609	9,29
2211 EKTN9/C3	106,54	H 311	36,70	FRB 9.5/100	9,17	ASNH 511-609	9,29
22211 EK	172,10	H 311	36,70	FRB 9.5/100	9,17	ASNH 511-609	9,29
1213 EKTN9/C3	126,45	H 213	41,17	FRB 14/120	12,00	ASNH 513-611	9,85
2213 EKTN9/C3	159,98	H 313	43,43	FRB 10/120	9,34	ASNH 513-611	9,85
22213 EK	228,89	H 313	43,43	FRB 10/120	9,34	ASNH 513-611	9,85
1215 K/C3	164,38	H 215	72,47	FRB 15.5/130	15,98	ASNH 515-612	12,17
2215 EKTN9/C3	257,90	H 315	75,13	FRB 12.5/130	14,72	ASNH 515-612	12,17
22215 EK	287,48	H 315	75,13	FRB 12.5/130	14,72	ASNH 515-612	12,17
1216 K/C3	194,33	H 216	87,11	FRB 16/140	15,98	ASNH 516-613	12,73
2216 EKTN9/C3	311,57	H 316	91,75	FRB 12.5/140	14,72	ASNH 516-613	12,73
22216 EK	326,18	H 316	91,75	FRB 12.5/140	14,72	ASNH 516-613	12,73
1217 K/C3	245,72	H 217	98,94	FRB 16.5/150	15,98	ASNH 517	13,76
2217 K/C3	381,69	H 317	105,17	FRB 12.5/150	14,39	ASNH 517	13,76
22217 EK	375,43	H 317	105,17	FRB 12.5/150	14,39	ASNH 517	13,76

SNL assembly table
 Auswahl-Tabelle SNL-Gehäuse, Lager und Zubehör
 Tableau des composants pour paliers SNL
 Tabella di composizione dei sopporti SNL
 Tabla de componentes para soportes SNL
 Samenstelling complete SNL lagerhuizen

Πίνακας εδράνων SNL
 SNL valintaulukko
 SNL-tabela de conjuntos
 SNL-lejehuse og tilbehør
 Kompletta SNL stålagerhus
 Komplette SNL-lagerhus

d_3	H_1	J	Housing	€	Double-lip seals	€	V-ring seals	€
85	112	290	SNL 519-616	404,69	TSN 519 L	48,36	TSN 519 A	68,84
85	112	290	SNL 519-616	404,69	TSN 519 L	48,36	TSN 519 A	68,84
90	112	320	SNL 520-617	455,95	TSN 520 L	55,70	TSN 520 A	67,46
90	112	320	SNL 520-617	455,95	TSN 520 L	55,70	TSN 520 A	67,46
90	112	320	SNL 520-617	455,95	TSN 520 L	55,70	TSN 520 A	67,46
90	112	320	SNL 520-617	455,95	TSN 520 L	55,70	TSN 520 A	67,46
100	125	350	SNL 522-619	619,16	TSN 522 L	60,74	TSN 522 A	72,45
100	125	350	SNL 522-619	619,16	TSN 522 L	60,74	TSN 522 A	72,45
100	125	350	SNL 522-619	619,16	TSN 522 L	60,74	TSN 522 A	72,45

Πίνακας εδράνων SNL
 SNL valintaulukko
 SNL-tabela de conjuntos
 SNL-lejehuse og tilbehør
 Kompletta SNL stålagerhus
 Komplette SNL-lagerhus

SNL assembly table
 Auswahl-Tabelle SNL-Gehäuse, Lager und Zubehör
 Tableau des composants pour paliers SNL
 Tabella di composizione dei sopporti SNL
 Tabla de componentes para soportes SNL
 Samenstelling complete SNL lagerhuizen

Bearing	€	Adapter sleeve	€	Locating ring	€	End cover	€
1219 K/C3	352,06	H 219	138,48	FRB 18/170	25,65	ASNH 519-616	21,31
22219 EK	521,88	H 319	135,71	FRB 12.5/170	23,31	ASNH 519-616	21,31
1220 K/C3	413,28	H 220	143,87	FRB 18/180	30,49	ASNH 520-617	21,22
2220 KM/C3	894,09	H 320	151,97	FRB 12/180	21,27	ASNH 520-617	21,22
22220 EK	584,97	H 320	151,97	FRB 12/180	21,27	ASNH 520-617	21,22
23220 CCK/W33	843,33	H 2320	208,99	FRB 4.85/180	18,21	ASNH 520-617	21,22
1222 K/C3	570,99	H 222	170,27	FRB 21/200	41,51	ASNH 522-619	25,47
2222 KM/C3	1121,06	H 322	191,35	FRB 13.5/200	34,43	ASNH 522-619	25,47
22222 EK	719,25	H 322	191,35	FRB 13.5/200	34,43	ASNH 522-619	25,47

SNL31 assembly table
Auswahl-Tabelle SNL31-Gehäuse, Lager und Zubehör
Tableau des composants pour paliers SNL31
Tabella di composizione dei sopporti SNL 31
Tabla de componentes para soportes SNL 31
Samenstelling complete SNL31 lagerhuizen

Πίνακας εδράνων SNL
SNL31 valintaulukko
SNL31-tabela de conjuntos
SNL31- lejehus og tilbehør
Kompletta SNL 31 stålagerhus
Komplette SNL31-lagerhus

d _a	H ₁	J	Housing	€	Labyrinth ring with silicone tube	€	End cover with silicone tube	€
		750	SNL 3164	***	TS 64	***	ETS 64	***
150	170	430	SNL 3134	2654,64	TS 34	208,99	ETS 34	211,22
160	180	450	SNL 3136	3087,85	TS 36	219,14	ETS 36	213,82
170	190	480	SNL 3138	3689,30	TS 38	249,36	ETS 38	232,43
180	200	510	SNL 3140	4626,87	TS 40	261,80	ETS 40	246,82
200		540	SNL 3144	***	TS 44	283,26	ETS 44	263,98
220		600	SNL 3148	***	TS 48	399,43	ETS 48	372,31
240		650	SNL 3152	***	TS 52	419,30	ETS 52	***
260		670	SNL 3156	***	TS 56	655,22	ETS 56	***
280		710	SNL 3160	***	TS 60	692,58	ETS 60	***

Πίνακας εδρώνων SNL
 SNL31 valintataulukko
 SNL31-tabela de conjuntos
 SNL31- lejehus og tilbehør
 Kompletta SNL 31 stålagerhus
 Komplette SNL31-lagerhus

SNL31 assembly table
 Auswahl-Tabelle SNL31-Gehäuse, Lager und Zubehör
 Tableau des composants pour paliers SNL31
 Tabella di composizione dei sopporti SNL 31
 Tabla de componentes para soportes SNL 31
 Samenstelling complete SNL31 lagerhuizen

Bearing	€	Adapter sleeve	€	Locating ring	€
23164 CCK/W33	***	OH 3164 H	***	FRB 10/540	***
23134 CCK/W33	2300,85	H 3134	669,29	FRB 10/280	52,95
23136 CCK/W33	2707,27	H 3136	798,75	FRB 10/300	65,90
23138 CCK/W33	3334,81	H 3138	918,93	FRB 10/320	84,89
23140 CCK/W33	3712,29	H 3140	1074,82	FRB 10/340	91,54
23144 CCK/W33	***	H 3144	1745,31	FRB 10/370	97,97
23148 CCK/W33	***	H 3148	1962,34	FRB 10/400	103,00
23152 CCK/W33	***	H 3152	2415,18	FRB 10/440	117,32
23156 CCK/W33	***	H 3156	2991,06	FRB 10/460	140,17
23160 CCK/W33	***	H 3160	3461,65	FRB 10/500	***

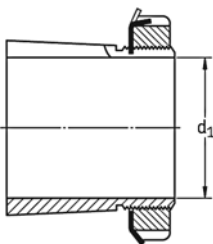

H 2(00)	132
H 3(00)	132
H 23(00)	132
H 30(00)	132
H 31(00)	132

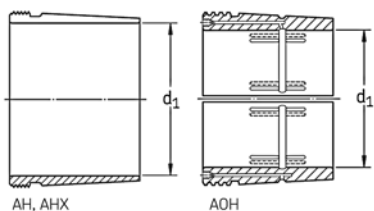

AH	134
AHX	134
AOH	134

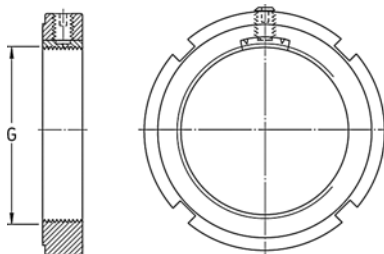

KMK	135
-----	-------	-----

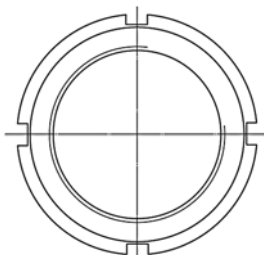

KM	136
KML	136
HM	137

KMT	137
KMTA	137
ETS	137
Z	137

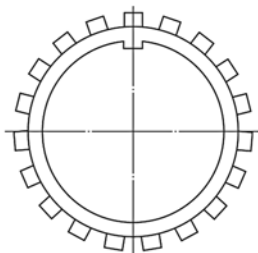

MB	138
MBL	138

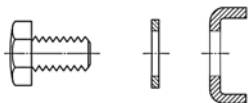

MS 138

	€	d ₁	min		€	d ₁	min
H 204	***	17		H 2310	42,83	45	
H 205	21,83	20		H 2311	46,89	50	
H 206	22,07	25		H 2312	62,47	55	
H 207	23,29	30		H 2313	71,64	60	
H 208	24,64	35		H 2314	***	60	
H 209	30,26	40		H 2315	97,09		
H 210	32,41	45		H 2316	115,99		
H 211	35,13	50		H 2317	123,61	75	
H 212	38,34	55		H 2318	153,35	80	
H 213	41,17	60		H 2319	***	85	
H 215	72,47	65		H 2320	208,99	90	
H 216	87,11	70		H 2322	243,58	100	
H 217	98,94	75		H 2324	334,50	110	
H 218	114,02	80		H 2326	453,27	115	
H 219	***	85		H 2328	533,11	125	
H 220	***	90		H 2330	690,15	135	
H 222	***	100		H 2332	773,74	140	
				H 2334	***	150	
				H 2336	***	160	
				H 2340	***	180	
H 305	***	20		H 3024	***	110	
H 306	22,60	25		H 3026	***	115	
H 307	24,94	30		H 3028	376,73	125	
H 308	26,83	35		H 3030	***	135	
H 309	31,03	40		H 3032	555,62	140	
H 310	35,13	45		H 3034	597,77	150	
H 311	36,70	50		H 3036	742,56	160	
H 312	38,94	55		H 3038	***	170	
H 313	43,43	60		H 3040	1102,58	180	
H 314	***	60		H 3044	***	200	
H 315	75,13	65		H 3048	***	220	
H 316	91,75	70		H 3052	***	240	
H 317	105,17	75		H 3056	***	260	
H 318	118,64	80					
H 319	135,71	85					
H 320	151,97	90		H 3122	231,63	100	
H 322	191,35	100		H 3124	230,70	110	
				H 3126	298,58	115	
				H 3128	384,73	125	
				H 3130	531,31	135	
H 2305	***	20		H 3132	621,53	140	
H 2306	***	25		H 3134	669,29	150	
H 2307	34,17	30		H 3136	798,75	160	
H 2308	34,49	35		H 3138	***	170	
H 2309	39,95	40		H 3140	1074,82	180	

Εξαρτήματα
Tarvikkeet
Acessórios
Tilbehør
Tillbehör
Tilbehør

Accessories
Zubehör
Accessoires
Accessori
Accesorios
Toebehoren

	€	d ₁	min		€	d ₁	min
H 3144	***	200					
H 3148	***	220					
H 3152	***	240					
H 3156	***	260					
H 3160	***	280					

	€	d ₁	min		€	d ₁	min
AH 2236 G	***	170		AH 3236 G	***	170	
AH 2238 G	***	180		AH 3238 G	***	180	
AH 2308	***	35		AH 3240	***	190	
AH 2309	***	40		AHX 2310	***	45	
AH 2313 G	***	60		AHX 2311	***	50	
AH 2332 G	***	150		AHX 2312	***	55	
AH 2334 G	***	160		AHX 2314 G	***	65	
AH 2336 G	***	170		AHX 2315 G	***	70	
AH 2338 G	***	180		AHX 2316	***	75	
AH 2340	***	190		AHX 2317	***	80	
AH 24024	***	115		AHX 2318	***	85	
AH 24026	***	125		AHX 2319	***	90	
AH 24028	***	135		AHX 2320	***	95	
AH 24030	***	145		AHX 2322 G	***	105	
AH 24032	***	150		AHX 2324 G	***	115	
AH 24034	***	160		AHX 2326 G	***	125	
AH 24036	***	170		AHX 2328 G	***	135	
AH 24040	***	190		AHX 2330 G	***	145	
AH 24122	***	105		AHX 3024	***	115	
AH 24124	***	115		AHX 3026	***	125	
AH 24126	***	125		AHX 3028	***	135	
AH 24128	***	135		AHX 3030	***	145	
AH 24130	***	145		AHX 310	***	45	
AH 24132	***	150		AHX 311	***	50	
AH 24134	***	160		AHX 312	***	55	
AH 24136	***	170		AHX 3120	***	95	
AH 24140	***	190		AHX 3122	***	105	
AH 3032	***	150		AHX 3124	***	115	
AH 3034	***	160		AHX 3126	***	125	
AH 3036	***	170		AHX 3128	***	135	
AH 3038 G	***	180		AHX 3130 G	***	145	
AH 3040 G	***	190		AHX 317	***	80	
AH 308	***	35		AHX 318	***	85	
AH 309	***	40		AHX 319	***	90	
AH 313 G	***	60		AHX 320	***	95	
AH 3132 G	***	150		AHX 3218	***	85	
AH 3134 G	***	160		AHX 3220	***	95	
AH 3136 G	***	170		AHX 3222 G	***	105	
AH 3138 G	***	180		AHX 3224 G	***	115	
AH 314 G	***	65		AHX 3226 G	***	125	
AH 3140	***	190		AHX 3228 G	***	135	
AH 315 G	***	70		AHX 3230 G	***	145	
AH 316	***	75		AQH 2344	***	200	
AH 3232 G	***	150		AQH 2348	***	220	
AH 3234 G	***	160		AQH 2356 G	***	260	

	€	d ₁	min		€	d ₁	min
A0H 24044	***	200					
A0H 24048	***	220					
A0H 24060 G	***	280					
A0H 24144	***	200					
A0H 24148	***	220					
A0H 24156	***	260					
A0H 24160	***	280					
A0H 3044 G	***	200					
A0H 3048	***	220					
A0H 3052	***	240					
A0H 3144	***	200					
A0H 3152 G	***	240					
A0H 3156 G	***	260					
KMK 0	***	10					
KMK 1	***	12					
KMK 10	***	50					
KMK 11	***	55					
KMK 12	***	60					
KMK 13	***	65					
KMK 14	***	70					
KMK 15	***	75					
KMK 16	***	80					
KMK 17	***	85					
KMK 18	***	90					
KMK 19	***	95					
KMK 2	***	15					
KMK 20	***	100					
KMK 3	***	17					
KMK 4	***	20					
KMK 5	***	25					
KMK 6	***	30					
KMK 7	***	35					
KMK 8	***	40					
KMK 9	***	45					

Accessories
Zubehör
Accessoires
Accessori
Accesorios
Toebehoren

Εξαρτήματα
Tarvikkeet
Acessórios
Tilbehør
Tilbehør
Tilbehør

	€	G	min		€	G	min
KM 0	4,98	10		KML 34	***	200	
KM 1	4,98	12		KML 36	***	210	
KM 10	15,19	50					
KM 11	16,40	55					
KM 12	17,71	60					
KM 13	21,40	65					
KM 14	24,74	70					
KM 15	25,76	75					
KM 16	34,89	80					
KM 17	43,68	85					
KM 18	50,96	90					
KM 19	55,41	95					
KM 2	5,50	15					
KM 20	61,84	100					
KM 21	66,62	105					
KM 22	80,77	110					
KM 23	114,45	115					
KM 24	96,75	120					
KM 25	***	125					
KM 26	117,16	130					
KM 27	***	135					
KM 28	147,10	140					
KM 29	***	145					
KM 3	6,88	17					
KM 30	171,07	150					
KM 31	***	155					
KM 32	190,69	160					
KM 33	***	165					
KM 34	***	170					
KM 36	244,90	180					
KM 38	***	190					
KM 4	9,17	20					
KM 40	***	200					
KM 5	9,77	25					
KM 6	10,56	30					
KM 7	12,15	35					
KM 8	12,34	40					
KM 9	13,08	45					
KML 24	***	145					
KML 26	***	155					
KML 28	***	165					
KML 30	***	180					
KML 32	***	190					

	€	G	min		€	G	min
HM 3044	***	260		KMTA 10	***	70	
HM 3048	***	290		KMTA 11	***	75	
HM 3052	***	310		KMTA 12	***	84	
HM 3056	***	330		KMTA 13	***	88	
HM 3060	***	360		KMTA 14	***	95	
HM 3064	***	380		KMTA 15	***	100	
HM 3068	***	400		KMTA 16	***	110	
HM 3160	***	380		KMTA 17	***	115	
HM 3164	***	400		KMTA 18	***	120	
				KMTA 19	***	125	
KMT 0	***	28		KMTA 20	***	130	
KMT 1	***	30		KMTA 22	***	140	
KMT 10	102,36	75		KMTA 24	***	155	
KMT 11	120,72	85		KMTA 26	***	165	
KMT 12	126,54	90		KMTA 28	***	180	
KMT 13	164,86	95		KMTA 32	***	205	
KMT 14	***	100		KMTA 34	***	215	
KMT 15	***	105		KMTA 36	***	230	
KMT 16	***	110		KMTA 38	***	240	
KMT 17	***	120		KMTA 5	***	42	
KMT 18	***	125		KMTA 6	***	48	
KMT 19	***	130		KMTA 7	***	53	
KMT 2	77,49	33		KMTA 8	***	58	
KMT 20	***	135		KMTA 9	***	68	
KMT 22	***	145					
KMT 24	***	155		ETS 34	***		
KMT 26	***	165		ETS 36	***		
KMT 28	***	175		ETS 38	***		
KMT 3	***	37		ETS 40	***		
KMT 30	***	185		ETS 44	***		
KMT 32	***	195		ETS 48	***		
KMT 34	***	205					
KMT 36	***	215					
KMT 38	***	225					
KMT 4	73,81	40					
KMT 40	***	235		Z 004	***	20	
KMT 5	79,42	44		Z 005	3,43	25	
KMT 6	84,10	49		Z 204	***	20	
KMT 7	91,73	54		Z 006	***	30	
KMT 8	97,31	65		Z 206	5,49	30	
KMT 9	108,25	70		Z 305	***	25	

	€	min		€	min
MB 0	***		MS 3044	***	
MB 1	***		MS 3052-48	***	
MB 10	1,82		MS 3056	***	
MB 11	2,26		MS 3060	***	
MB 12	2,47		MS 3068-64	***	
MB 13	2,66		MS 3160	***	
MB 14	3,00		MS 3164	***	
MB 15	3,11				
MB 16	4,26				
MB 17	***				
MB 18	5,18				
MB 19	***				
MB 2	***				
MB 20	7,28				
MB 21	***				
MB 22	***				
MB 23	***				
MB 24	***				
MB 25	***				
MB 26	***				
MB 27	***				
MB 28	***				
MB 29	***				
MB 3	***				
MB 30	***				
MB 31	***				
MB 32	***				
MB 33	***				
MB 34	***				
MB 36	***				
MB 38	***				
MB 4	1,31				
MB 40	***				
MB 5	1,31				
MB 6	1,31				
MB 7	1,31				
MB 8	1,58				
MB 9	1,61				
MBL 28	***				
MBL 32	***				
MBL 36	***				

Βελονοειδή ρουλεμάν
 Neulalaakerit
 Rolamentos de agulhas
 Nålelejer
 Nåtrullager
 Nålerullelager

Needle roller bearings
 Nadellager
 Roulements à aiguilles
 Cuscinetti a rullini
 Rodamientos de agujas
 Naaldlagers

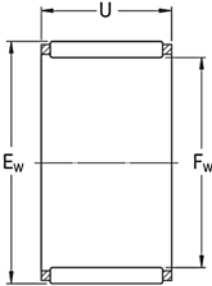

K 143

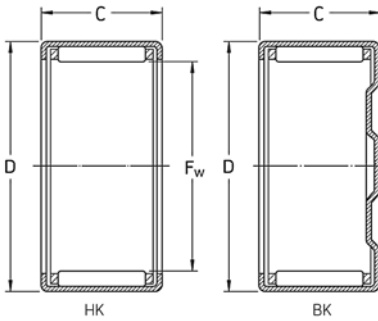

HK 143

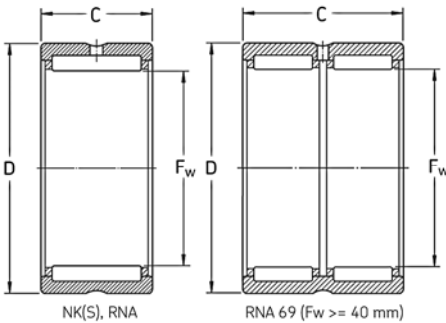

NK 144
 NKS 145
 RNA 48 145
 RNA 49 145
 RNA 69 145

Needle roller bearings
 Nadellager
 Roulements à aiguilles
 Cuscinetti a rullini
 Rodamientos de agujas
 Naaldlagers

Βελονοειδή ρουλεμάν
 Neulalaakerit
 Rolamentos de agulhas
 Nåltejer
 Nålrollager
 Nålertullelager

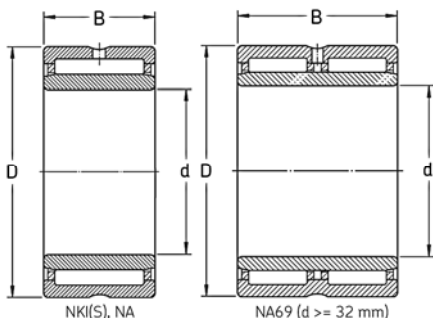

NKI	146
NKIS	146
NA 48	147
NA 49	147
NA 69	148

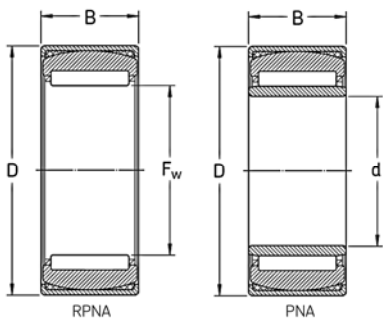

RPNA	148
PNA	149

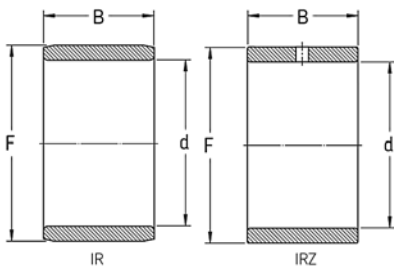

IR	149
----	-------	-----

Βελονοειδή ρουλεμάν
 Neulalaakerit
 Rolamentos de agulhas
 Nålelejer
 Nåtrullager
 Nålerullelager

Needle roller bearings
 Nadellager
 Roulements à aiguilles
 Cuscinetti a rullini
 Rodamientos de agujas
 Naaldlagers

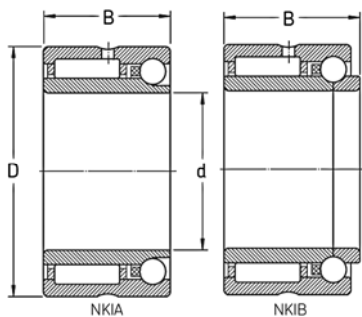

NKIA 150
 NKIB 150

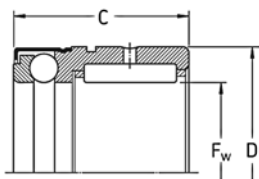

NX 151

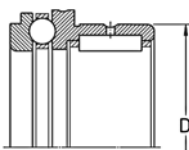

NKX 151

Needle roller bearings
Nadellager
Roulements à aiguilles
Cuscinetti a rullini
Rodamientos de agujas
Naaldlagers

Βελονοειδή ρουλεμάν
Neulalaakerit
Rolamentos de agulhas
Nålelejer
Nålrullager
Nålerullelager

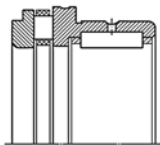

NKXR 152

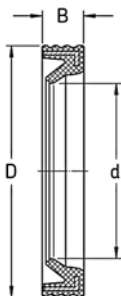

G 152

	€	F _w	E _w	U	min		€	F _w	E _w	U	min
K 10X13X10 TN	***	10	13	10	10	HK 0306 TN	4,27	3	6,5	6	10
K 10X14X13 TN	***	10	14	13	10	HK 0408	4,27	4	8	8	10
K 18X24X12	***	18	24	12	10	HK 0509	***	5	9	9	10
K 20X26X17	***	20	26	17	5	HK 0608	4,15	6	10	8	10
K 20X28X25	***	20	28	25	5	HK 0609	4,15	6	10	9	10
K 25X30X20	***	25	30	20		HK 0709	***	7	11	9	10
K 25X33X20	***	25	33	20	5	HK 0808	4,27	8	12	8	10
K 25X35X30	***	25	35	30	5	HK 0810	4,27	8	12	10	10
K 40X48X20	***	40	48	20	10	HK 0810 RS	***	8	12	10	10
						HK 0812.2RS	***	8	12	12	10
						HK 0910	***	9	13	10	10
						HK 0912	4,33	9	13	12	10
						HK 1010	4,33	10	14	10	10
						HK 1012	4,59	10	14	12	10
						HK 1012 RS	***	10	14	12	10
						HK 1014.2RS	7,65	10	14	14	5
						HK 1015	4,84	10	14	15	5
						HK 1210	4,59	12	16	10	10
						HK 1212	4,84	12	18	12	10
						HK 1214 RS	6,59	12	18	14	5
						HK 1216.2RS	7,34	12	18	16	
						HK 1312	***	13	19	12	
						HK 1412	5,09	14	20	12	10
						HK 1416.2RS	***	14	20	16	5
						HK 1512	5,16	15	21	12	10
						HK 1516	5,42	15	21	16	5
						HK 1612	5,26	16	22	12	10
						HK 1616	***	16	22	16	5
						HK 1616.2RS	***	16	22	16	5
						HK 1622	***	16	22	22	5
						HK 1712	***	17	23	12	10
						HK 1812	***	18	24	12	10
						HK 1816	6,04	18	24	16	5
						HK 2012	5,74	20	26	12	10
						HK 2016	6,26	20	26	16	5
						HK 2020	6,94	20	26	20	5
						HK 2020.2RS	9,45	20	26	20	5
						HK 2030	10,96	20	26	30	5
						HK 2212	***	22	28	12	
						HK 2220	***	22	28	20	5
						HK 2512	***	25	32	12	10
						HK 2516	***	25	32	16	5
						HK 2520	7,42	25	32	20	5
						HK 2520.2RS	***	25	32	20	5
						HK 2526	8,50	25	32	26	5

Needle roller bearings
Nadellager
Roulements à aiguilles
Cuscinetti a rullini
Rodamientos de agujas
Naaldlagers

Βελονοειδή ρουλεμάν
Neulalaakerit
Rolamentos de agulhas
Nålelager
Nålruullager
Nålerullelager

	€	F _w	D	C	min		€	F _w	D	C	min
HK 2530.2RS	***	25	32	30	5	NK 5/10 TN	***	5	10	10	10
HK 2538	***	25	32	38	5	NK 5/12 TN	***	5	10	12	10
HK 2816	***	28	35	16	5	NK 6/10 TN	12,08	6	12	10	10
HK 2820	***	28	35	20		NK 6/12 TN	12,08	6	12	12	10
HK 3012	***	30	37	12	10	NK 7/10 TN	***	7	14	10	10
HK 3016	***	30	37	16	5	NK 8/12 TN	12,08	8	15	12	10
HK 3020	8,22	30	37	20	5	NK 8/16 TN	12,88	8	15	16	5
HK 3026	9,51	30	37	26	5	NK 9/12 TN	***	9	16	12	10
HK 3038	***	30	37	38	5	NK 10/12 TN	12,58	10	17	12	10
HK 3512	***	35	42	12	10	NK 10/16 TN	13,23	10	17	16	5
HK 3516	***	35	42	16	10	NK 12/12	13,07	12	19	12	10
HK 3520	9,73	35	42	20	5	NK 12/16	13,42	12	19	16	5
HK 4016	***	40	47	16		NK 14/16	***	14	22	16	5
HK 4018 RS	***	40	47	18		NK 14/20	***	14	22	20	5
HK 4020	11,73	40	47	20		NK 15/16	***	15	23	16	5
HK 4020.2RS	***	40	47	20		NK 16/16	***	16	24	16	5
HK 4520	13,47	45	52	20		NK 16/20	***	16	24	20	5
HK 5020	***	50	58	20		NK 17/16	***	17	25	16	5
HK 5025	16,77	50	58	25		NK 17/20	***	17	25	20	5
HK 5520	***	55	63	20		NK 18/16	***	18	26	16	5
HK 6020	***	60	68	20		NK 18/20	***	18	26	20	5
						NK 19/16	***	19	27	16	5
						NK 20/16	16,55	20	28	16	5
						NK 20/20	18,98	20	28	20	5
						NK 22/16	***	22	30	16	5
						NK 22/20	***	22	30	20	5
						NK 24/16	***	24	32	16	5
						NK 24/20	21,95	24	32	20	
						NK 25/16	***	25	33	16	5
						NK 25/20	22,32	25	33	20	5
						NK 26/20	***	26	34	20	5
						NK 28/20	***	28	37	20	5
						NK 28/30	***	28	37	30	5
						NK 30/30 TN	***	30	40	30	5
						NK 35/20 TN	25,39	35	45	20	10
						NK 38/20	***	38	48	20	
						NK 40/20 TN	28,46	40	50	20	
						NK 40/30	34,81	40	50	30	
						NK 42/20	***	42	52	20	
						NK 45/20 TN	33,38	45	55	20	
						NK 45/30 TN	***	45	55	30	
						NK 50/25 TN	38,25	50	62	25	
						NK 50/35 TN	***	50	62	35	
						NK 55/25	***	55	68	25	5
						NK 60/25 TN	***	60	72	25	

Βελονοειδή ρουλεμάν
Nedlataakerit
Rolamentos de agulhas
Nålelejer
Nålruullager
Nålerullelager

Needle roller bearings
Nadellager
Roulements à aiguilles
Cuscinetti a rullini
Rodamientos de agujas
Naaldlagers

	€	F _w	D	C	min		€	F _w	D	C	min
NK 60/35	***	60	72	35		NKS 25	***	25	38	20	5
NK 65/25	***	65	78	25		NKS 35	43,11	35	50	22	
NK 68/25	***	68	82	25		NKS 45	***	45	60	22	
NK 70/25	***	70	85	25		NKS 50	***	50	65	22	5
NK 70/35	***	70	85	35		NKS 60	***	60	80	28	
NK 75/35	***	75	92	35		RNA 4822	***	120	140	30	
NK 80/25	***	80	95	25		RNA 4824	***	130	150	30	
NK 80/35	***	80	95	35	5	RNA 4828	***	155	175	35	
NK 85/25	***	85	105	25		RNA 4830	***	165	190	40	
NK 85/35	***	85	105	35		RNA 4832	***	175	200	40	
NK 90/25	***	90	110	25		RNA 4900	18,60	14	22	13	10
NK 90/35	***	90	110	35		RNA 4900.2RS	***	14	22	13	10
NK 100/26	***	100	120	26		RNA 4901	***	16	24	13	
NK 105/26	***	105	125	26		RNA 4901.2RS	***	16	24	13	10
NK 110/40	***	110	130	40		RNA 4902	20,73	20	28	13	10
						RNA 4902.2RS	31,85	20	28	13	10
						RNA 4903	22,54	22	30	13	10
						RNA 4904	24,33	25	37	17	5
						RNA 4904.2RS	***	25	37	17	5
						RNA 4905	27,40	30	42	17	5
						RNA 4905.2RS	***	30	42	17	
						RNA 4906	31,85	35	47	17	
						RNA 4906.2RS	***	35	47	17	
						RNA 49/32	***	40	52	20	
						RNA 4907	***	42	55	20	5
						RNA 4908	***	48	62	22	
						RNA 4908.2RS	***	48	62	22	
						RNA 4910	***	58	72	22	5
						RNA 4911	***	63	80	25	5
						RNA 4912	***	68	85	25	5
						RNA 4913	***	72	90	25	5
						RNA 4914	***	80	100	30	5
						RNA 4916	***	90	110	30	
						RNA 4917	***	100	120	35	
						RNA 4918	***	105	125	35	
						RNA 4919	***	110	130	35	
						RNA 4924	***	135	165	45	
						RNA 6901	***	16	24	22	5
						RNA 6902	24,33	20	28	23	5
						RNA 6904	***	25	37	30	5
						RNA 69/22	43,48	28	39	30	5
						RNA 6905	45,71	30	42	30	5

Needle roller bearings
 Nadellager
 Roulements à aiguilles
 Cuscinetti a rullini
 Rodamientos de agujas
 Naaldlagers

Βελονοειδή ρουλεμάν
 Neulaalakerit
 Rolamentos de agulhas
 Nālelejer
 Nālrullager
 Nālerullelager

	€	F _w	D	C	min		€	F _w	D	C	min
RNA 69/28	***	32	45	30		NKI 6/16 TN	***	6	16	16	5
RNA 6906	57,87	35	47	30		NKI 9/12	***	9	19	12	10
RNA 69/32	***	40	52	36		NKI 10/20	***	10	22	20	5
RNA 6908	***	48	62	40		NKI 12/16	21,37	12	24	16	5
RNA 6909	***	52	68	40		NKI 12/20	***	12	24	20	5
RNA 6910	***	58	72	40		NKI 15/16	22,32	15	27	16	5
RNA 6911	***	63	80	45		NKI 15/20	24,70	15	27	20	5
RNA 6912	***	68	85	45		NKI 17/16	***	17	29	16	5
RNA 6913	***	72	90	45		NKI 17/20	***	17	29	20	5
RNA 6914	***	80	100	54		NKI 20/16	26,40	20	32	16	5
RNA 6916	***	90	110	54		NKI 20/20	29,99	20	32	20	5
RNA 6917	***	100	120	63		NKI 22/16	***	22	34	16	5
						NKI 22/20	***	22	34	20	5
						NKI 25/30	37,19	25	38	30	5
						NKI 28/30	***	28	42	30	5
						NKI 32/20	***	32	47	20	
						NKI 32/30	***	32	47	30	
						NKI 35/30	51,68	35	50	30	
						NKI 38/30	***	38	53	30	
						NKI 42/30	***	42	57	30	
						NKI 50/25	***	50	68	25	
						NKI 50/35	80,83	50	68	35	
						NKI 55/35	***	55	72	35	
						NKI 60/25	***	60	82	25	
						NKI 60/35	***	60	82	35	
						NKI 70/25	***	70	95	25	
						NKI 70/35	***	70	95	35	
						NKI 75/25	***	75	105	25	
						NKI 75/35	***	75	105	35	
						NKI 80/25	***	80	110	25	
						NKI 80/35	***	80	110	35	
						NKI 85/26	***	85	115	26	
						NKI 85/36	***	85	115	36	
						NKI 90/26	***	90	120	26	
						NKI 90/36	***	90	120	36	
						NKI 95/26	***	95	125	26	
						NKI 95/36	***	95	125	36	
						NKI 100/30	***	100	130	30	
						NKI 100/40	***	100	130	40	
						NKIS 20	***	20	42	20	5
						NKIS 25	***	25	47	22	10
						NKIS 30	63,90	30	52	22	
						NKIS 35	***	35	58	22	5
						NKIS 40	***	40	65	22	5

Βελονοειδή ρουλεμάν
 Neulataakerit
 Rolamentos de agulhas
 Nālelejer
 Nālrullager
 Nālerullelager

Needle roller bearings
 Nadellager
 Roulements à aiguilles
 Cuscinetti a rullini
 Rodamientos de agujas
 Naaldlagers

	€	d	D	B	min		€	d	D	B	min
NKIS 45	***	45	72	22	NA 4822	***	110	140	30		
NKIS 50	***	50	80	28	NA 4824	***	120	150	30		
NKIS 55	***	55	85	28	NA 4826	430,61	130	165	35		
NKIS 60	***	60	90	28	NA 4828	***	140	175	35		
NKIS 65	***	65	95	28	NA 4830	***	150	190	40		
					NA 4832	***	160	200	40		
					NA 4834	***	170	215	45		
					NA 4836	***	180	225	45		
					NA 4838	***	190	240	50		
					NA 4900	25,13	10	22	13	10	
					NA 4900.2RS	35,60	10	22	14	5	
					NA 4901	26,08	12	24	13		
					NA 4901.2RS	37,14	12	24	14	5	
					NA 4902	27,72	15	28	13		
					NA 4902.2RS	39,25	15	28	14	5	
					NA 4903	30,36	17	30	13	10	
					NA 4903.2RS	42,32	17	30	14	5	
					NA 4904	33,06	20	37	17	5	
					NA 4904.2RS	44,86	20	37	18	5	
					NA 49/22	***	22	39	17	5	
					NA 4905	36,87	25	42	17	5	
					NA 4905.2RS	49,57	25	42	18	5	
					NA 49/28	***	28	45	17	10	
					NA 4906	42,32	30	47	17		
					NA 4906.2RS	56,29	30	47	18		
					NA 49/32	***	32	52	20		
					NA 4907	47,87	35	55	20		
					NA 4907.2RS	62,63	35	55	21		
					NA 4908	54,91	40	62	22		
					NA 4908.2RS	70,36	40	62	23		
					NA 4909	61,79	45	68	22		
					NA 4909.2RS	***	45	68	23		
					NA 4910	69,09	50	72	22	5	
					NA 4910.2RS	***	50	72	23		
					NA 4911	***	55	80	25		
					NA 4912	99,98	60	85	25		
					NA 4913	***	65	90	25		
					NA 4914	155,00	70	100	30	5	
					NA 4915	***	75	105	30		
					NA 4916	***	80	110	30		
					NA 4917	***	85	120	35		
					NA 4918	***	90	125	35		
					NA 4919	***	95	130	35		
					NA 4920	352,31	100	140	40		
					NA 4922	399,92	110	150	40		

Needle roller bearings
 Nadellager
 Roulements à aiguilles
 Cuscinetti a rullini
 Rodamientos de agujas
 Naaldlagers

Βελονοειδή ρουλεμάν
 Neulaakerit
 Rolamentos de agulhas
 Nålelejer
 Nålrullager
 Nålerullelager

	€	d	D	B	min		€	d	D	B	min
NA 4924	***	120	165	45		RPNA 20/35	***	20	35	16	5
NA 4926	***	130	180	50		RPNA 25/42	***	25	42	20	5
NA 4928	***	140	190	50		RPNA 30/47	***	30	47	20	
NA 6902	***	15	28	23	5	RPNA 45/62	***	45	62	20	
NA 6903	36,92	17	30	23	5						
NA 6904	***	20	37	30	5						
NA 69/22	***	22	39	30	5						
NA 6905	61,15	25	42	30	5						
NA 6906	74,38	30	47	30							
NA 69/32	***	32	52	36							
NA 6907	***	35	55	36							
NA 6908	101,46	40	62	40							
NA 6909	***	45	68	40							
NA 6910	134,37	50	72	40							
NA 6911	***	55	80	45							
NA 6912	***	60	85	45							
NA 6913	211,07	65	90	45							
NA 6914	***	70	100	54							
NA 6915	***	75	105	54							
NA 6916	***	80	110	54							
NA 6917	***	85	120	63							

Βελονοειδή ρουλεμάν
 Neulataakerit
 Rolamentos de agulhas
 Nålelejer
 Nålrullager
 Nålerullelager

Needle roller bearings
 Nadellager
 Roulements à aiguilles
 Cuscinetti a rullini
 Rodamientos de agujas
 Naaldlagers

	€	d	D	B	min		€	d	D	B	min
PNA 15/32	***	15	32	16	5	IR 8X12X10 IS1	7,81	8	12	10	10
PNA 30/52	***	30	52	20		IR 10X14X16	***	10	14	16	5
PNA 35/55	***	35	55	20		IR 10X14X20	***	10	14	20	5
PNA 40/62	***	40	62	20		IR 15X19X20	***	15	19	20	5
						IR 17X20X16	***	17	20	16	5
						IR 17X22X16	***	17	22	16	5
						IR 17X20X20	8,80	17	20	20	5
						IR 17X22X23	12,25	17	22	23	5
						IR 17X20X30.5	11,65	17	20	30,5	5
						IR 20X24X20	***	20	24	20	5
						IR 20X25X20	***	20	25	20	5
						IR 20X25X20.5	9,19	20	25	20,5	5
						IR 20X25X30	15,71	20	25	30	5
						IR 20X25X38.5	16,95	20	25	38,5	5
						IR 25X30X17	***	25	30	17	5
						IR 25X30X20	***	25	30	20	5
						IR 25X30X26.5	***	25	30	26,5	5
						IR 25X30X30	***	25	30	30	5
						IR 25X30X38.5	17,95	25	30	38,5	5
						IR 28X32X30	***	28	32	30	5
						IR 30X35X13	***	30	35	13	10
						IR 30X35X16	***	30	35	16	5
						IR 30X35X20	11,66	30	35	20	5
						IR 30X35X26	***	30	35	26	5
						IR 30X35X30	19,81	30	35	30	5
						IR 32X37X30	***	32	37	30	5
						IR 32X40X36	***	32	40	36	5
						IR 35X40X20	13,28	35	40	20	5
						IR 35X40X30	19,34	35	40	30	5
						IR 35X42X36	***	35	42	36	5
						IR 40X45X20	14,60	40	45	20	
						IR 40X48X22	***	40	48	22	10
						IR 40X50X22	***	40	50	22	
						IR 40X45X30	20,84	40	45	30	
						IR 40X48X40	***	40	48	40	
						IR 45X55X22	***	45	55	22	
						IR 45X50X25	17,88	45	50	25	
						IR 45X50X35	22,27	45	50	35	
						IR 50X58X22	***	50	58	22	5
						IR 50X55X25	***	50	55	25	
						IR 50X60X28	***	50	60	28	
						IR 50X55X35	***	50	55	35	
						IR 50X58X40	***	50	58	40	
						IR 55X65X28	***	55	65	28	
						IR 55X60X35	***	55	60	35	

Needle roller bearings
 Nadellager
 Roulements à aiguilles
 Cuscinetti a rullini
 Rodamientos de agujas
 Naaldlagers

Βελονοειδή ρουλεμάν
 Neulaakaerit
 Rolamentos de agulhas
 Nålelejer
 Nålrullager
 Nålerullelager

	€	d	F	B	min		€	d	F	B	min
IR 55X63X45	***	55	63	45		NKIA 5901	38,30	12	24	16	5
IR 60X70X25	33,17	60	70	25		NKIA 5902	40,89	15	28	18	5
IR 60X70X28	***	60	70	28		NKIA 5903	44,28	17	30	18	5
IR 60X68X45	***	60	68	45		NKIA 5904	***	20	37	23	5
IR 65X72X25	***	65	72	25	5	NKIA 5905	58,93	25	42	23	5
IR 70X80X25	***	70	80	25		NKIA 5906	66,34	30	47	23	
IR 70X80X30	***	70	80	30	5	NKIA 5907	***	35	55	27	
IR 70X80X35	***	70	80	35		NKIA 5908	***	40	62	30	
IR 70X80X54	***	70	80	54		NKIA 5910	***	50	72	30	
IR 75X85X35	***	75	85	35		NKIA 5912	***	60	85	34	
IR 75X85X54	***	75	85	54		NKIA 5914	***	70	100	40	
IR 80X90X25	***	80	90	25							
IR 80X90X35	***	80	90	35							
IR 80X90X54	***	80	90	54							
IR 85X95X26	***	85	95	26							
IR 85X100X35	***	85	100	35	5	NKIB 5901	47,72	12	24	17,5	10
IR 85X95X36	***	85	95	36		NKIB 5902	***	15	28	20	5
IR 90X100X26	***	90	100	26		NKIB 5903	***	17	30	20	5
IR 90X100X36	***	90	100	36		NKIB 5904	***	20	37	25	5
IR 100X110X30	***	100	110	30		NKIB 5905	72,68	25	42	25	5
IR 100X110X40	***	100	110	40		NKIB 5906	83,05	30	47	25	
IR 100X115X40	***	100	115	40		NKIB 5907	***	35	55	30	
IR 110X120X30	***	110	120	30		NKIB 5908	***	40	62	34	
						NKIB 5909	***	45	68	34	
						NKIB 5910	***	50	72	34	
						NKIB 5911	***	55	80	38	
						NKIB 5912	***	60	85	38	
						NKIB 5913	***	65	90	38	
						NKIB 5914	***	70	100	45	

Βελονοειδή ρουλεμάν
 Neulataakerit
 Rolamentos de agulhas
 Nålelejer
 Nålrullager
 Nålerullelager

Needle roller bearings
 Nadellager
 Roulements à aiguilles
 Cuscinetti a rullini
 Rodamientos de agujas
 Naaldlagers

	€	F _w	D	C	min		€	F _w	D	C	min
NX 7 ZTN	***	7	14	18	5	NKX 12 Z	***	12	27,2	23	5
NX 10 Z	42,16	10	19	18	5	NKX 15 Z	54,38	15	29,2	23	5
NX 12 Z	***	12	21	18	5	NKX 17	***	17	30	25	5
NX 20 Z	***	20	30	28	5	NKX 17 Z	57,56	17	31,2	25	5
NX 25 Z	***	25	37	30	5	NKX 20	***	20	35	30	5
NX 30 Z	***	30	42	30	5	NKX 20 Z	66,87	20	36,2	30	5
						NKX 25	***	25	42	30	5
						NKX 25 Z	75,96	25	43,2	30	
						NKX 30	***	30	47	30	
						NKX 30 Z	97,23	30	48,2	30	
						NKX 35	***	35	52	30	
						NKX 35 Z	***	35	53,2	30	
						NKX 40	***	40	60	32	
						NKX 40 Z	123,79	40	61,2	32	
						NKX 45	***	45	65	32	
						NKX 45 Z	***	45	66,5	32	
						NKX 50	***	50	70	35	
						NKX 50 Z	155,53	50	70	35	
						NKX 60	***	60	85	40	
						NKX 60 Z	***	60	85	40	
						NKX 70	***	70	85	40	
						NKX 70 Z	***	70	95	40	

Needle roller bearings
 Nadellager
 Roulements à aiguilles
 Cuscinetti a rullini
 Rodamientos de agujas
 Naaldlagers

Βελονοειδή ρουλεμάν
 Neulaakerit
 Rolamentos de agulhas
 Nålelejer
 Nålrullager
 Nålerullelager

	€	d	D	B	min		€	d	D	B	min
NKXR 15 Z	***	15	29,2	23	5	G 12X19X3	***	12	19	3	25
NKXR 20	***	20	35	30	5	G 14X20X3	***	14	20	3	25
NKXR 20 Z	99,35	20	36,2	30	5	GE 12 TXGR	***	12	22	10	10
NKXR 25 Z	***	25	43,2	30	5	GE 15 TXGR	***	15	26	12	10
NKXR 30 Z	***	30	48,2	30		G 20X28X4	***	20	28	4	25
NKXR 35 Z	***	35	53,2	30		G 22X30X4	***	22	30	4	25
NKXR 40 Z	***	40	61,2	32		GE 17 TXGR	***	17	30	14	10
NKXR 45 Z	***	45	66,5	32		G 35X42X4	***	35	42	4	25
NKXR 50 Z	***	50	71,5	35		GE 25 TXE-2LS	***	25	42	20	10
						GEZ 208 ES-2RS	***	63,5	100	55,5	

Ωστικά βελονοειδή ρουλεμάν
 Paineneulalaakerit
 Rolamentos axiais de agulhas
 Aksialnålelejer
 Axialnålrullager
 Aksialnålerullelager

Needle roller thrust bearings
 Axial-Nadellager
 Butées à aiguilles
 Cuscinetti assiali a rullini
 Rodamientos axiales de agujas
 Naaldtaatslagers

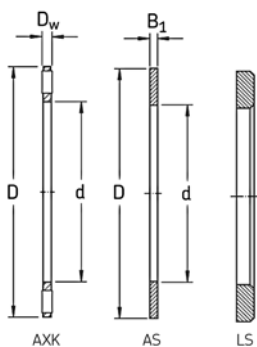

AXK	154
AS	154
LS	154

Needle roller thrust bearings
 Axial-Nadellager
 Butées à aiguilles
 Cuscinetti assiali a rullini
 Rodamientos axiales de agujas
 Naalddaatslagers

Ωστικά βελονοειδή ρουλεμάν
 Paineneulalaakerit
 Rolamentos axiais de agulhas
 Aksiaalnälelejer
 Axialnålrullager
 Aksiaalrullelager

	€	d	D _w	B	min		€	d	D _w	B	min
AXK 0821 TN	3,51	8	21	2	10	AS 0821	***	8	21	1	10
AXK 1024	3,20	10	24	2	10	AS 1024	***	10	24	1	10
AXK 1226	3,24	12	26	2	10	AS 1226	0,87	12	26	1	10
AXK 1528	3,29	15	28	2	10	AS 1528	0,87	15	28	1	10
AXK 1730	3,32	17	30	2	10	AS 1730	0,87	17	30	1	10
AXK 2035	3,62	20	35	2	10	AS 2035	0,87	20	35	1	10
AXK 2542	3,84	25	42	2	10	AS 2542	***	25	42	1	10
AXK 3047	4,26	30	47	2	100	AS 3047	1,26	30	47	1	100
AXK 3552	4,97	35	52	2	10	AS 3552	1,41	35	52	1	100
AXK 4060	5,50	40	60	3	10	AS 4060	2,04	40	60	1	10
AXK 4565	***	45	65	3		AS 4565	***	45	65	1	10
AXK 5070	7,42	50	70	3		AS 5070	2,53	50	70	1	10
AXK 5578	***	55	78	3		AS 5578	***	55	78	1	10
AXK 6085	***	60	85	3		AS 6085	***	60	85	1	
AXK 6590	13,20	65	90	3		AS 75100	***	75	100	1	10
AXK 7095	***	70	95	4		AS 90120	***	90	120	1	
AXK 75100	***	75	100	4		AS 100135	***	100	135	1	
AXK 80105	***	80	105	4	10						
AXK 85110	***	85	110	4	10						
AXK 90120	***	90	120	4							
AXK 100135	***	100	135	4		LS 1024	***	10	24	2,8	10
						LS 1226	***	12	26	2,8	10
						LS 1528	***	15	28	2,8	10
						LS 2035	***	20	35	2,8	10
						LS 2542	***	25	42	3	10
						LS 3047	7,62	30	47	3	10
						LS 3552	***	35	52	3,5	100
						LS 4060	8,75	40	60	3,5	
						LS 4565	***	45	65	4	
						LS 5070	***	50	70	4	

Ωστικά κυλινδρικά ρουλεμάν
 Lieriõmäiset painerullalaakerit
 Rolamentos axiais de rolos cilíndricos
 Cylindriske aksialrullelejer
 Cylindriska axialrullager
 Sýlindriske aksialrullelager

Cylindrical roller thrust bearings
 Axial-Zylinderrollenlager
 Butées à rouleaux cylindriques
 Cuscinetti assiali a rulli cilindrici
 Rodamientos axiales de rodillos cilíndricos
 Cilindertaatslagers

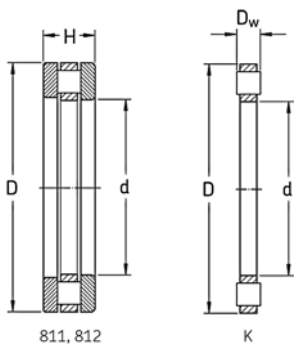

811	156
812	156
K 811	156
WS 811	157
GS 811	157

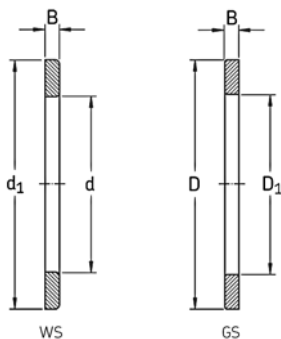

Cylindrical roller thrust bearings
 Axial-Zylinderrollenlager
 Butées à rouleaux cylindriques
 Cuscinetti assiali a rulli cilindrici
 Rodamientos axiales de rodillos cilíndricos
 Cilindertaatslagers

Ωστικά κυλινδρικά ρουλεμάν
 Lieriömäiset painerullalaakerit
 Rolamentos axiais de rolos cilíndricos
 Cylindriske aksialrullelejer
 Cylindriska axialrullager
 Sylindriske aksialrullelager

	€	d	D	H	min		€	d	D	H	min
81102 TN	***	15	28	9		K 81105 TN	***	25	42	5	
81104 TN	***	20	35	10		K 81106 TN	***	30	47	5	
81105 TN	***	25	42	11							
81106 TN	***	30	47	11							
81107 TN	***	35	52	12							
81108 TN	***	40	60	13							
81109 TN	***	45	65	14							
81110 TN	73,88	50	70	14							
81111 TN	***	55	78	16							
81112 TN	***	60	85	17							
81114 TN	***	70	95	18							
81118 TN	***	90	120	22							
81120 TN	***	100	135	25							
81206 TN	69,31	30	52	16							
81207 TN	***	35	62	18							
81208 TN	87,17	40	68	19							
81209 TN	***	45	73	20							
81210 TN	***	50	78	22							
81211 TN	***	55	90	25							
81212 TN	***	60	95	26							
81213 TN	***	65	100	27							
81214 TN	***	70	105	27							
81216 TN	***	80	115	28							

Ωστικά κυλινδρικά ρουλεμάν
 Lieriömäiset painerullalaakerit
 Rolamentos axiais de rolos cilíndricos
 Cylindriske aksialrullelejer
 Cylindriska axialrullager
 Sylindriske aksialrullelager

Cylindrical roller thrust bearings
 Axial-Zylinderrollenlager
 Butées à rouleaux cylindriques
 Cuscinetti assiali a rulli cilindrici
 Rodamientos axiales de rodillos cilíndricos
 Cilindertaatslagers

	€	d	d ₁	B	min		€	d	d ₁	B	min
WS 81104	***	20	35	2,8		GS 81104	***	21	35	2,8	
WS 81105	***	25	42	3		GS 81105	***	26	42	3	
WS 81106	***	30	47	3		GS 81106	***	32	47	3	
WS 81108	***	40	60	3,5		GS 81107	***	37	52	3,5	
WS 81109	***	45	65	4		GS 81108	***	42	60	3,5	
WS 81111	***	55	78	5							

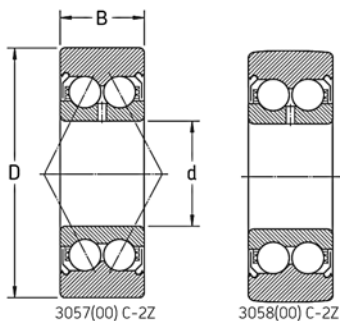

3057 (00) C-ZZ	162
3058 (00) C-ZZ	162

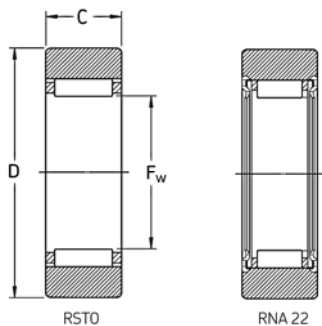

RST0	163
RNA 22	163

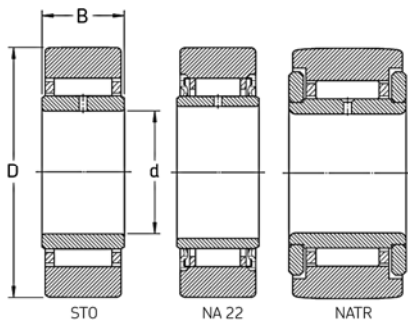

ST0	163
NA 22	163
NATR	163

Track Runner bearings
 Lauf-, Stütz- und Kurvenrollen
 Galets
 Rotelle
 Roldanas
 Loop-, steun- en nokrollen

Πόυλα
 Juoksu-, tuki- ja nokkarullat
 Rolos de leva e de apoio
 Løbe-, støtte- og kamruller
 Löp-, stöd- och kamrullar
 Løpe-, støtte- og kamruller

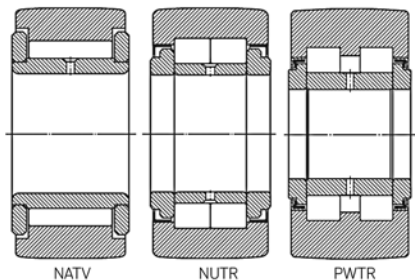

NATV 164
 NUTR 164

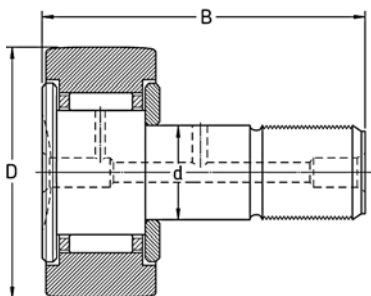

KR 164

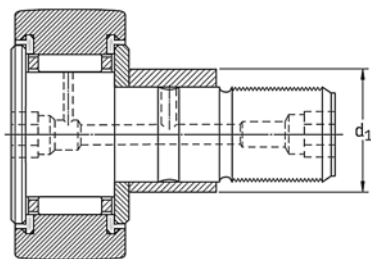

KRE 165

Ράουλα

Juoksu-, tuki- ja nokkarullat

Rolos de leva e de apoio

Løbe-, støtte- og kamruller

Löp-, stöd- och kamrullar

Løpe-, støtte- og kamruller

Track Runner bearings

Lauf-, Stütz- und Kurvenrollen

Galets

Rotelle

Roldanas

Loop-, steun- en nokrollen

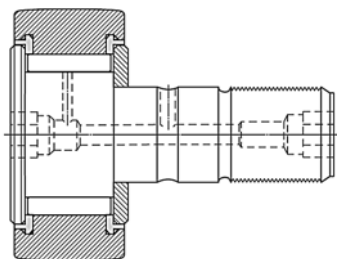

KRV 165

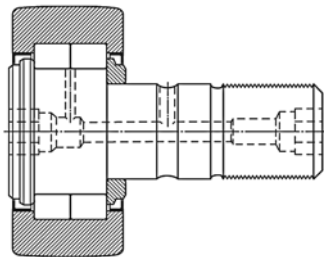

NUKR 165

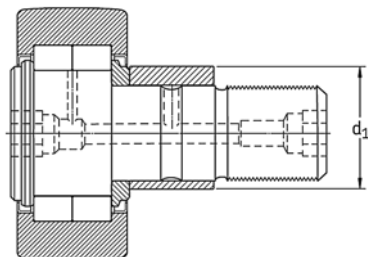

NUKRE 165

Track Runner bearings
 Lauf-, Stütz- und Kurvenrollen
 Galets
 Rotelle
 Roldanas
 Loop-, steun- en nokrollen

Ράουλα
 Juoksu-, tuki- ja nokkarullat
 Rolos de leva e de apoio
 Løbe-, støtte- og kamruller
 Löp-, stöd- och kamrullar
 Løpe-, støtte- og kamruller

	€	d	D	B	min		€	d	D	B	min
305701 C-ZZ	68,30	12	35	15,9	10	305800 C-ZZ	68,30	10	32	14	10
305702 C-ZZ	70,76	15	40	15,9	10	305801 C-ZZ	68,30	12	35	15,9	10
305703 C-ZZ	76,22	17	47	17,5	5	305802 C-ZZ	70,76	15	40	15,9	10
305704 C-ZZ	81,65	20	52	20,6	10	305803 C-ZZ	76,22	17	47	17,5	5
305705 C-ZZ	96,51	25	62	20,6	5	305804 C-ZZ	81,65	20	52	20,6	10
305706 C-ZZ	114,01	30	72	23,8	5	305805 C-ZZ	96,51	25	62	20,6	5
305707 C-ZZ	130,37	35	80	27	5	305806 C-ZZ	114,01	30	72	23,8	5
						305807 C-ZZ	130,37	35	80	27	5

Ράουλα
Juoksu-, tuki- ja nokkarullat
Rolos de leva e de apoio
Løbe-, støtte- og kamruller
Löp-, stöd- och kamrullar
Løpe-, støtte- og kamruller

Track Runner bearings
Lauf-, Stütz- und Kurvenrollen
Galets
Rotelle
Roldanas
Loop-, steun- en nokrollen

	€	F _w	D	C	min		€	F _w	D	C	min
RSTO 5 TN	13,98	7	16	7,8	10	STO 6 TN	24,92	6	19	10	10
RSTO 12	***	16	32	11,8	10	STO 8 TN	***	8	24	10	10
						STO 10	***	10	30	12	10
						STO 15	***	15	35	12	10
RNA 22/8.2RS	21,90	12	24	11,8	10	NA 22/8.2RS	30,68	8	24	12	10
RNA 2204.2RS	***	25	47	17,8		NA 2200.2RS	***	10	30	14	5
						NA 2201.2RS	***	12	32	14	5
						NA 2202.2RS	***	15	35	14	5
						NA 2203.2RS	***	17	40	16	5
						NA 2204.2RS	60,62	20	47	18	
						NA 2205.2RS	***	25	52	18	
						NA 2206.2RS	***	30	62	20	
						NATR 5	***	5	16	12	10
						NATR 5 PPA	29,47	5	16	12	10
						NATR 6	***	6	19	12	10
						NATR 6 PPA	29,73	6	19	12	10
						NATR 6 PPXA	32,90	6	19	12	10
						NATR 8	***	8	24	15	5
						NATR 8 PPA	34,44	8	24	15	5
						NATR 8 PPXA	37,82	8	24	15	5
						NATR 10	***	10	30	15	5
						NATR 10 PPA	49,09	10	30	15	5
						NATR 10 PPXA	***	10	30	15	5
						NATR 12	***	12	32	15	5
						NATR 12 PPA	54,17	12	32	15	5
						NATR 12 PPXA	***	12	32	15	5
						NATR 15	***	15	35	19	5
						NATR 15 PPA	59,04	15	35	19	5
						NATR 15 PPXA	***	15	35	19	5
						NATR 17	***	17	40	21	5
						NATR 17 PPA	64,01	17	40	21	5
						NATR 17 PPXA	***	17	40	21	5
						NATR 20	***	20	47	25	
						NATR 20 PPA	71,52	20	47	25	
						NATR 20 PPXA	***	20	47	25	
						NATR 25	***	25	52	25	
						NATR 25 PPA	78,29	25	52	25	
						NATR 25 PPXA	***	25	52	25	
						NATR 30	***	30	62	29	
						NATR 30 PPA	95,33	30	62	29	
						NATR 30 PPXA	***	30	62	29	
						NATR 35 PPA	***	35	72	29	

Track Runner bearings
Lauf-, Stütz- und Kurvenrollen
Galets
Rotelle
Roldanas
Loop-, steun- en nokrollen

Ράουλα
Juoksu-, tuki- ja nokkarullat
Rolos de leva e de apoio
Løbe-, støtte- og kamruller
Löp-, stöd- och kamruller
Løpe-, støtte- og kamruller

	€	d	D	B	min		€	d	D	B	min
NATR 40 PPA	***	40	80	32		KR 16	43,59	6	16	28	
						KR 16 PPA	46,45	6	16	28	
						KR 16 PPSKA	***	6	16	28	
						KR 16 PPXA	51,10	6	16	28	
						KR 19	45,65	8	19	32	
NATV 5 PPA	29,47	5	16	12	10	KR 19 PPA	48,46	8	19	32	
NATV 6 PPA	29,73	6	19	12	10	KR 19 PPXA	53,22	8	19	32	
NATV 8 PPA	34,44	8	24	15	5	KR 22 B	47,72	10	22	36	
NATV 10 PPA	49,09	10	30	15	5	KR 22 PPA	51,10	10	22	36	
NATV 12 PPA	54,17	12	32	15	5	KR 22 PPXA	56,29	10	22	36	
NATV 15 PPA	59,04	15	35	19	5	KR 26 B	49,78	10	26	36	
NATV 17 PPA	64,01	17	40	21	5	KR 26 PPA	54,17	10	26	36	
NATV 17 PPXA	***	17	40	21	5	KR 26 PPXA	***	10	26	36	
NATV 20 PPA	71,52	20	47	25		KR 30 B	60,31	12	30	40	
NATV 20 PPXA	79,03	20	47	25		KR 30 PPA	64,43	12	30	40	
NATV 25 PPA	78,29	25	52	25		KR 30 PPXA	70,78	12	30	40	
NATV 30 PPA	95,33	30	62	29		KR 32 B	63,37	12	32	40	
NATV 40 PPA	***	40	80	32		KR 32 PPA	68,03	12	32	40	
NATV 40 PPXA	***	40	80	32		KR 32 PPXA	***	12	32	40	
						KR 35 B	***	16	35	52	
NUTR 15 A	61,68	15	35	19	5	KR 35 PPA	76,18	16	35	52	
NUTR 15 X	68,14	15	35	19	5	KR 35 PPXA	***	16	35	52	
NUTR 17 A	66,97	17	40	21	5	KR 40 B	***	18	40	58	
NUTR 17 X	73,95	17	40	21	5	KR 40 PPA	89,82	18	40	58	
NUTR 1542 A	74,27	15	42	19	5	KR 40 PPXA	***	18	40	58	
NUTR 1747 A	***	17	47	21		KR 47 B	***	20	47	66	
NUTR 20 A	73,11	20	47	25		KR 47 PPA	116,91	20	47	66	
NUTR 20 X	***	20	47	25		KR 47 PPXA	***	20	47	66	
NUTR 2052 A	80,51	20	52	25		KR 52 B	***	20	52	66	
NUTR 2052 X	***	20	52	25		KR 52 PPA	120,08	20	52	66	
NUTR 25 A	80,51	25	52	25		KR 62 PPA	151,82	24	62	80	
NUTR 25 X	88,24	25	52	25		KR 72 PPA	168,75	24	72	80	
NUTR 2562 A	96,81	25	62	25		KR 80 PPA	221,12	30	80	100	
NUTR 2562 X	***	25	62	25		KR 90 PPA	***	30	90	100	
NUTR 30 A	96,81	30	62	29							
NUTR 3072 A	112,15	30	72	29							
NUTR 35 A	111,09	35	72	29							
NUTR 3580 A	123,79	35	80	29							
NUTR 40 A	140,71	40	80	32							
NUTR 45 A	***	45	85	32							
NUTR 4090 A	159,76	40	90	32							
NUTR 50 A	186,74	50	90	32							
NUTR 45100 A	185,15	45	100	32							
NUTR 50110 A	238,05	50	110	32							
NUTR 50110 X	260,80	50	110	32							

	€	d ₁	D	B	min		€	d ₁	D	B	min
KRE 22 PPA	***	10	22	36							
KRE 30 PPA	***	12	30	40							
KRE 40 PPA	***	18	40	58							
KRE 52 PPA	***	20	52	66							
KRV 16 PPA	46,45	6	16	28							
KRV 19 PPA	48,46	8	19	32							
KRV 19 PPXA	***	8	19	32							
KRV 22 PPA	51,10	10	22	36							
KRV 22 PPXA	56,29	10	22	36							
KRV 26 PPA	54,17	10	26	36							
KRV 30 PPA	64,43	12	30	40							
KRV 32 PPA	68,03	12	32	40							
KRV 35 PPA	76,18	16	35	52							
KRV 40 PPA	89,82	18	40	58							
KRV 47 PPA	***	20	47	66							
KRV 52 PPA	120,08	20	52	66							
KRV 62 PPA	151,82	24	62	4							
KRV 72 PPA	***	24	72	80							
KRV 80 PPA	221,12	30	80	100							
KRV 90 PPA	***	30	90	100							
NUKR 35 A	81,36	16	35	52							
NUKR 35 XA	***	16	35	52							
NUKR 40 A	96,81	18	40	58							
NUKR 40 XA	***	18	40	58							
NUKR 47 A	125,37	20	47	66							
NUKR 52 A	130,13	20	52	66							
NUKR 52 XA	***	20	52	66							
NUKR 62 A	166,64	24	62	80							
NUKR 72 A	186,74	24	72	80							
NUKR 80 A	238,58	30	80	100							
NUKR 90 A	280,90	30	90	100							
NUKRE 35 A	***	16	35	52							
NUKRE 40 A	***	18	40	58							
NUKRE 47 A	***	20	47	66							
NUKRE 52 A	157,11	20	52	66							
NUKRE 62 A	***	24	62	80							
NUKRE 80 A	***	30	80	100							
NUKRE 90 A	320,05	30	90	100							

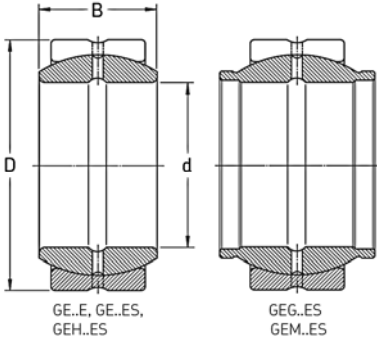

GE .. E	169
GE .. ES	169
GEH .. ES	169
GEG .. ES	169
GEM .. ES	169



GE .. C	169
GE .. TXA	170
GE .. TXE	170
GE .. TXG	170
GEH .. C	170
GEK .. ES	170
GEZ .. ES	170

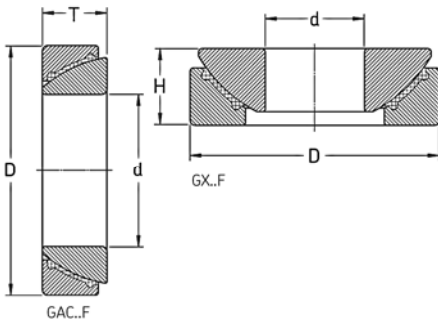

GAC .. F	171
GX .. F	171

Plain bearings
 Gleitlager
 Rotules
 Snodi sferici
 Cojinetes lisos
 Glijlagers

Έδρανα αρθρώσεων και ακρόμπατα

Nivellaakerit
 Rótulas
 Glidelejer
 Glidlager
 Glidelager

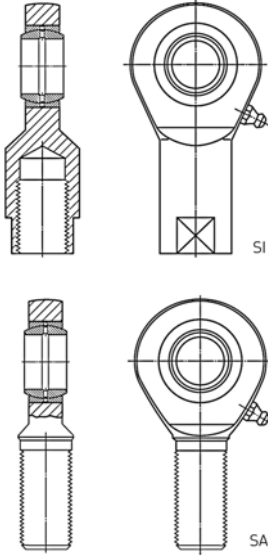

SA .. TXE	171
SI	172
SIA	172
SA .. E	172
SA .. ES	172
SC	172
SCF	172
SIQG	172
SIR	172
SIKAC	172
SAKAC	173
SA .. C	173
SIKB	173
SAKB	173
SAL .. E	173
SAL .. ES	173
SALKB .. F	173
SILKAC .. M	173
SILKB .. F	173
SIL .. ES	174
SIL .. E	174
SALKAC .. M	174

Έδρανα αρθρώσεων και ακρόμιατα

Nivellaakerit

Rótulas

Glidelejer

Glidlager

Glidlager

Plain bearings

Gleitlager

Rotules

Snodi sferici

Cojinetes lisos

Glijlagers

	€	d	D	B	min		€	d	D	B	min
GE 4 E	***	4	12	5	10	GE 200 ES-2RS	***	200	290	130	
GE 5 E	***	5	14	6	10						
GE 6 E	15,70	6	14	6	10						
GE 8 E	15,43	8	16	8	10						
GE 10 E	15,65	10	19	9	10						
GE 12 E	16,15	12	22	10	10	GEH 20 ES-2RS	38,70	20	42	25	10
GE 15 ES	23,05	15	26	12	10	GEH 25 ES-2RS	45,64	25	47	28	10
GE 15 ES-2RS	30,36	15	26	12	10	GEH 30 ES-2RS	61,74	30	55	32	5
GE 17 ES	23,35	17	30	14	10	GEH 35 ES-2RS	74,79	35	62	35	5
GE 17 ES-2RS	27,51	17	30	14	10	GEH 40 ES-2RS	91,53	40	68	40	
GE 20 ES	23,05	20	35	16	10	GEH 45 ES-2RS	104,97	45	75	43	
GE 20 ES-2RS	31,84	20	35	16	10	GEH 50 ES-2RS	176,33	50	90	56	
GE 25 ES	30,06	25	42	20	10	GEH 60 ES-2RS	254,43	60	105	63	
GE 25 ES-2RS	35,29	25	42	20	10	GEH 70 ES-2RS	337,29	70	120	70	
GE 30 ES	31,44	30	47	22	10	GEH 80 ES-2RS	***	80	130	75	
GE 30 ES-2RS	40,42	30	47	22	10	GEH 90 ES-2RS	***	90	150	85	
GE 35 ES	40,42	35	55	25	5	GEH 100 ES-2RS	***	100	160	85	
GE 35 ES-2RS	49,26	35	55	25	5	GEH 110 ES-2RS	***	110	180	100	
GE 40 ES	47,97	40	62	28	5						
GE 40 ES-2RS	58,99	40	62	28	5						
GE 45 ES	57,54	45	68	32	5	GEG 16 ES	35,97	16	28	16	10
GE 45 ES-2RS	68,38	45	68	32	5	GEG 20 ES	***	20	35	20	10
GE 50 ES	74,89	50	75	35	5	GEG 25 ES	47,29	25	42	25	10
GE 50 ES-2RS	85,73	50	75	35	5	GEG 32 ES	67,97	32	52	32	10
GE 60 ES	117,90	60	90	44		GEG 40 ES	85,73	40	62	40	
GE 60 ES-2RS	131,88	60	90	44		GEG 50 ES	***	50	75	50	
GE 70 ES	164,42	70	105	49		GEG 63 ES	***	63	95	63	
GE 70 ES-2RS	193,42	70	105	49		GEG 80 ES	***	80	120	80	
GE 80 ES	222,40	80	120	55		GEG 100 ES	***	100	150	100	
GE 80 ES-2RS	259,81	80	120	55		GEG 125 ES	***	125	180	125	
GE 90 ES	***	90	130	60		GEM 20 ES-2RS	***	20	35	24	10
GE 90 ES-2RS	339,43	90	130	60		GEM 25 ES-2RS	56,98	25	42	29	10
GE 100 ES	***	100	150	70		GEM 30 ES-2RS	60,21	30	47	30	10
GE 100 ES-2RS	455,91	100	150	70		GEM 35 ES-2RS	***	35	55	35	5
GE 110 ES	***	110	160	70		GEM 40 ES-2RS	80,87	40	62	38	
GE 110 ES-2RS	***	110	160	70		GEM 45 ES-2RS	***	45	68	40	
GE 120 ES	725,21	120	180	85		GEM 50 ES-2RS	112,74	50	75	43	
GE 120 ES-2RS	789,50	120	180	85		GEM 60 ES-2RS	***	60	90	54	
GE 140 ES	***	140	210	90		GEM 70 ES-2RS	***	70	105	65	
GE 140 ES-2RS	1293,36	140	210	90							
GE 160 ES	***	160	230	105		GE 4 C	***	4	12	5	10
GE 160 ES-2RS	***	160	230	105		GE 6 C	***	6	14	6	10
GE 180 ES	***	180	260	105		GE 8 C	22,57	8	16	8	10
GE 180 ES-2RS	***	180	260	105		GE 10 C	22,20	10	19	9	10
GE 200 ES	***	200	290	130		GE 12 C	23,32	12	22	10	10

Plain bearings
 Gleitlager
 Rotules
 Snodi sferici
 Cojinetes lisos
 Glijlager

Έδρανα αρθρώσεων και ακρόμπατα
 Nivellaakerit
 Rótulas
 Glidlejer
 Glijlager

	€	d	D	B	min		€	d	D	B	min
						GEK 22 ESA	***	22	43	28	10
GE 15 C	24,22	15	26	12	10						
GE 17 C	26,86	17	30	14	10						
GE 20 C	31,27	20	35	16	10						
GE 25 C	41,37	25	42	20	10						
GE 30 C	49,59	30	47	22	10						
						GEZ 014 ES	***	22,2	36,5	19,4	
GE 100 TXA-2LS	***	100	150	70		GEZ 204 ES	146,11	57,1	90,5	50	
GE 110 TXA-2LS	***	110	160	70			5				
GE 120 TXA-2LS	***	120	180	85							
GE 140 TXA-2RS	***	140	210	90							
GE 160 TXA-2RS	***	160	230	105							
GE 180 TXA-2RS	***	180	260	105							
GE 200 TXA-2RS	***	200	290	130							
GE 30 TXE-2LS	101,99	30	47	22							
GE 35 TXE-2LS	106,18	35	55	25							
GE 40 TXE-2LS	122,72	40	62	28							
GE 45 TXE-2LS	144,30	45	68	32							
GE 50 TXE-2LS	157,52	50	75	35							
GE 60 TXE-2LS	256,03	60	90	44							
GE 70 TXE-2LS	299,28	70	105	49							
GE 80 TXE-2LS	380,56	80	120	55							
GE 90 TXE-2LS	485,78	90	130	60							
GE 20 TXG3E	178,79	20	35	16							
GE 25 TXG3E	213,28	25	42	20							
GE 30 TXG3E-2LS	177,45	30	47	22							
GE 35 TXG3E-2LS	***	35	55	25							
GE 40 TXG3E-2LS	254,50	40	62	28							
GE 45 TXG3E-2LS	***	45	68	32							
GE 50 TXG3E-2LS	***	50	75	35							
GE 60 TXG3E-2LS	***	60	90	44							
GEH 10 C	26,67	10	22	12							
GEH 12 C	29,37	12	26	15							
GEH 15 C	32,24	15	30	16							
GEH 17 C	40,30	17	35	20							
GEH 20 C	52,20	20	42	25							
GEH 25 C	63,64	25	47	28							

Έδρανα αρθρώσεων και ακρόμπαρα

Nivellaakerit

Rótulas

Glidelejer

Glidlager

Glidelager

Plain bearings

Gleitlager

Rotules

Snodi sferici

Cojinetes lisos

Glijlagers

	€	d	D	T	min		€	d	D	T	min
GAC 30 F	***				5	GX 17 F	123,14	17	47	16	10
GAC 25 F	***	25	47	15	10	GX 20 F	***	20	55	20	5
GAC 35 F	***	35	62	18	5	GX 25 F	***	25	62	22,5	5
GAC 40 F	***	40	68	19	5	GX 30 F	***	30	75	26	5
GAC 45 F	***	45	75	20	5	GX 35 F	***	35	90	28	
GAC 50 F	***	50	80	20	5	GX 40 F	***	40	105	32	
GAC 60 F	***	60	95	23	5	GX 45 F	***	45	120	36,5	
GAC 70 F	***	70	110	25	5	GX 50 F	***	50	130	42,5	
GAC 80 F	***	80	125	29		GX 60 F	***	60	150	45	
GAC 100 F	***	100	150	32		GX 70 F	***	70	160	50	
GAC 120 F	***	120	180	38		SA 35 TXE-2LS	***				
						SA 45 TXE-2LS	***				
						SA 50 TXE-2LS	***				
						SA 40 TXE-2LS	***				

Plain bearings
 Gleitlager
 Rotules
 Snodi sferici
 Cojinetes lisos
 Glijlagers

Έδρανα αρθρώσεων και ακρόμπαρα

Nivellaakerit
 Rótulas
 Glidlejer
 Glidlager
 Glidelager

	€	min		€	min
SI 10 C	47,13		SC 20 ES	***	
SI 10 E	40,73		SC 25 ES	***	
SI 12 C	***		SC 30 ES	***	
SI 12 E	47,13		SC 35 ES	***	
SI 15 C	***		SC 40 ES	***	
SI 15 ES	***		SC 45 ES	***	
SI 17 C	***		SC 50 ES	***	
SI 17 ES	64,54		SC 60 ES	***	
SI 20 C	83,47				
SI 20 ES	75,66				
SI 25 C	***		SCF 25 ES	***	
SI 25 ES	103,04		SCF 30 ES	***	
SI 30 C	***		SCF 35 ES	***	
SI 30 ES	***		SCF 40 ES	***	
SI 35 ES-2RS	***		SCF 45 ES	***	
SI 40 ES-2RS	***		SCF 50 ES	***	
SI 45 ES-2RS	***		SCF 60 ES	***	
SI 50 ES-2RS	***		SCF 70 ES	***	
SI 6 C	***		SCF 80 ES	***	
SI 6 E	36,83		SCF 20 ES	***	
SI 8 C	44,82		SIQG 100 ES	***	
SI 8 E	37,81		SIQG 12 ESA	***	10
SI 50 TXE-2LS	***		SIQG 16 ES	***	5
SI 35 TXE-2LS	***		SIQG 20 ES	***	5
SI 40 TXE-2LS	***		SIQG 32 ES	***	
SIA 40 ES-2RS	***		SIQG 40 ES	***	
SIA 60 ES-2RS	***		SIQG 50 ES	***	
			SIQG 63 ES	***	
			SIQG 80 ES	***	
			SIQG 25 ES	148,90	5
SA 10 E	37,33		SIR 20 ES	***	5
SA 6 E	33,36		SIR 25 ES	***	5
SA 8 E	34,48		SIR 30 ES	***	
SA 12 E	42,39		SIR 35 ES	***	
SA 15 ES	54,26		SIR 40 ES	***	
SA 17 ES	59,50		SIR 50 ES	***	
SA 20 ES	72,12		SIR 60 ES	***	
SA 25 ES	95,95		SIR 70 ES	***	
SA 30 ES	138,06		SIR 80 ES	***	
SA 35 ES-2RS	***				
SA 40 ES-2RS	***		SIKAC 10 M/VZ019	38,05	10
SA 45 ES-2RS	***		SIKAC 12 M/VZ019	54,51	5
SA 50 ES-2RS	***		SIKAC 16 M/VZ019	93,23	5
SA 60 ES-2RS	***		SIKAC 30 M/VZ019	***	
			SIKAC 5 M	58,34	10

Έδρανα αρθρώσεων και ακρόμπαπα

Nivellaakerit

Rótulas

Glidelejer

Glidlager

Glidlager

Plain bearings

Gleitlager

Rotules

Snodi sferici

Cojinetes lisos

Glijlayers

	€	min		€	min
SIKAC 6 M	34,00	10	SIKB 20 F	114,87	
SIKAC 8 M	35,47	10	SIKB 22 F	***	5
SIKAC 10 M	38,05	10	SIKB 8 F	36,10	10
SIKAC 12 M	54,51	5	SIKB 5 F	30,73	10
SIKAC 14 M	80,23	5	SIKB 6 F	32,04	10
SIKAC 16 M	93,23	5	SAKB 10 F	43,44	10
SIKAC 18 M	***	5	SAKB 12 F	49,77	5
SIKAC 20 M	121,53	5	SAKB 14 F	***	5
SIKAC 22 M	***	5	SAKB 16 F	76,69	5
SIKAC 25 M	***	5	SAKB 18 F	***	5
SIKAC 30 M	***		SAKB 20 F	***	5
			SAKB 6 F	***	10
			SAKB 8 F	35,16	10
SAKAC 10 M	45,92	10	SAL 12 E	50,28	5
SAKAC 12 M	52,50	5			
SAKAC 14 M	74,39	5			
SAKAC 16 M	80,88	5			
SAKAC 18 M	***	5			
SAKAC 20 M	105,00	5	SAL 17 ES	***	
SAKAC 22 M	***	5	SAL 20 ES	***	
SAKAC 25 M	***	5			
SAKAC 30 M	***				
SAKAC 5 M	58,34	10			
SAKAC 6 M	34,00	10	SALKB 12 F	***	
SAKAC 8 M	37,15	10	SALKB 16 F	***	
SA 10 C	43,72	10	SILKAC 5 M	***	18 9 36 10
SA 15 C	***	5	SILKAC 6 M	35,73	20 11 40 10
SA 17 C	***	5	SILKAC 8 M	37,27	24 14 48 10
SA 20 C	80,10	5	SILKAC 10 M	39,90	29 17 57,5 10
SA 30 C	156,51		SILKAC 12 M	57,28	34 67 19 5
SA 6 C	***	10	SILKAC 14 M	***	38 76 22 5
SA 8 C	41,53	10	SILKAC 16 M	97,91	42 85 22 5
SA 25 C	***	5	SILKAC 20 M	***	50 102 32 5
SA 12 C	55,61	5			
SIKB 10 F	45,29	10	SILKB 12 F	59,62	5
SIKB 12 F	51,86	5	SILKB 8 F	***	10
SIKB 14 F	***	5			
SIKB 16 F	88,33	5			
SIKB 18 F	***	5			

Plain bearings
 Gleitlager
 Rotules
 Snodi sferici
 Cojinetes lisos
 Glijlagers

Έδρανα αρθρώσεων και ακρόμπαρα
 Nivellaakerit
 Rótulas
 Glidlejer
 Glidelager
 Glidelager

	€	d	D	B	min		€	d	D	B	min
SIL 20 ES	***				5						
SIL 12 E	***				5						
SIL 8 E	44,88				10						
SALKAC 10 M	48,16				10						
SALKAC 12 M	55,12				5						
SALKAC 16 M	84,93				5						
SALKAC 20 M	***				5						
SALKAC 6 M	35,73				10						
SALKAC 8 M	39,01				10						

Ρουλεμάν υψηλής ακριβείας
 Tarkkuuslaakerit
 Rolamentos de alta precisão
 Højpræcisionslejer
 Precisionslager
 Høypresisjonslager

High Precision Bearings
 Hochgenauigkeitslager
 Roulements de haute précision
 Cuscinetti di precisione
 Rodamientos de alta precisión
 Hoge-precisielagers

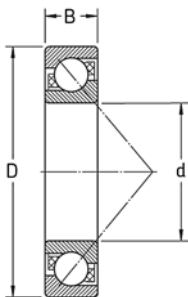

70 .. P4A	178
718 .. P4A	178
719 .. P4A	178
72 .. P4A	179

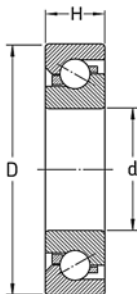

BSA	181
-----	-------	-----

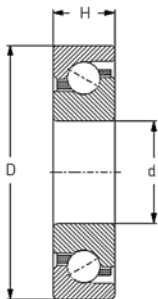

BSD	181
-----	-------	-----

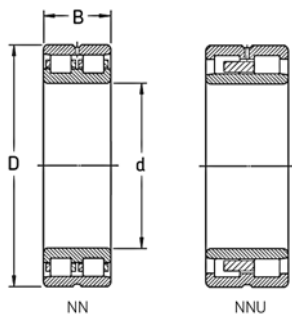

NNU 49 181

Ρουλεμάν υψηλής ακριβείας
Tarkkuuslaakerit
Rolamentos de alta precisão
Højpræcisionslejer
Precisionslager
Høypresisjonslager

High Precision Bearings
Hochgenauigkeitslager
Roulements de haute précision
Cuscinetti di precisione
Rodamientos de alta precisión
Høge-precisielagers

	€	d	D	B	min		€	d	D	B	min
708 ACDGA/P4A	***	8	22	7		7020 CDGA/P4A	***	100	150	24	
708 CDGA/P4A	***	8	22	7		7021 ACDGA/P4A	***	105	160	26	
709 ACDGA/P4A	***	9	24	7		7021 CDGA/P4A	***	105	160	26	
709 CDGA/P4A	***	9	24	7		7022 ACDGA/P4A	***	110	170	28	
7000 ACDGA/P4A	***	10	26	8		7022 CDGA/P4A	***	110	170	28	
7000 CDGA/P4A	***	10	26	8		7024 ACDGA/P4A	***	120	180	28	
7001 ACDGA/P4A	***	12	28	8		7024 CDGA/P4A	***	120	180	28	
7001 CDGA/P4A	***	12	28	8		7026 ACDGA/P4A	***	130	200	33	
7002 ACDGA/P4A	***	15	32	9		7026 CDGA/P4A	***	130	200	33	
7002 CDGA/P4A	***	15	32	9		7028 ACDGA/P4A	***	140	210	33	
7003 ACDGA/P4A	***	17	35	10		7028 CDGA/P4A	***	140	210	33	
7003 CDGA/P4A	***	17	35	10		7030 ACDGA/P4A	***	150	225	35	
7004 ACDGA/P4A	***	20	42	12		7030 CDGA/P4A	***	150	225	35	
7004 CDGA/P4A	***	20	42	12		7032 ACDGA/P4A	***	160	240	38	
7005 ACDGA/P4A	***	25	47	12		7032 CDGA/P4A	***	160	240	38	
7005 CDGA/P4A	***	25	47	12		7034 ACDGA/P4A	***	170	260	42	
7006 ACDGA/P4A	***	30	55	13		7034 CDGA/P4A	***	170	260	42	
7006 CDGA/P4A	***	30	55	13		71800 ACDGA/P4	***				
7007 ACDGA/P4A	***	35	62	14		71801 CDGA/P4	***				
7007 CDGA/P4A	***	35	62	14		71802 CDGA/P4	***				
7008 ACDGA/P4A	***	40	68	15		71804 ACDGA/P4	***				
7008 CDGA/P4A	***	40	68	15		71804 CDGA/P4	***				
7009 ACDGA/P4A	***	45	75	16		71805 ACDGA/P4	***				
7009 CDGA/P4A	***	45	75	16		71805 CDGA/P4	***				
7010 ACDGA/P4A	***	50	80	16		71806 ACDGA/P4	***				
7010 CDGA/P4A	***	50	80	16		71806 CDGA/P4	***				
7011 ACDGA/P4A	***	55	90	18		71807 ACDGA/P4	***				
7011 CDGA/P4A	***	55	90	18		71807 CDGA/P4	***				
7012 ACDGA/P4A	***	60	95	18		71808 ACDGA/P4	***				
7012 CDGA/P4A	***	60	95	18		71808 CDGA/P4	***				
7013 ACDGA/P4A	***	65	100	18		71809 CDGA/P4	***				
7013 CDGA/P4A	***	65	100	18		71810 CDGA/P4	***				
7014 ACDGA/P4A	***	70	110	20		71812 ACDGA/P4	***				
7014 CDGA/P4A	***	70	110	20		71812 CDGA/P4	***				
7015 ACDGA/P4A	***	75	115	20		71813 ACDGA/P4	***				
7015 CDGA/P4A	***	75	115	20		71900 CDGA/P4A	***	10	22	6	
7016 ACDGA/P4A	***	80	125	22		71901 ACDGA/P4A	***	12	24	6	
7016 CDGA/P4A	***	80	125	22		71901 CDGA/P4A	***	12	24	6	
7017 ACDGA/P4A	***	85	130	22		71902 ACDGA/P4A	***	15	28	7	
7017 CDGA/P4A	***	85	130	22		71902 CDGA/P4A	***	15	28	7	
7018 ACDGA/P4A	***	90	140	24		71903 ACDGA/P4A	***	17	30	7	
7018 CDGA/P4A	***	90	140	24		71903 CDGA/P4A	***	17	30	7	
7019 ACDGA/P4A	***	95	145	24		71904 ACDGA/P4A	***	20	37	9	
7019 CDGA/P4A	***	95	145	24		71904 CDGA/P4A	***	20	37	9	
7020 ACDGA/P4A	***	100	150	24		71905 ACDGA/P4A	***	25	42	9	

* = Matchable



High Precision Bearings
Hochgenauigkeitslager
Roulements de haute précision
Cuscinetti di precisione
Rodamientos de alta precisión
Høge-precisielagers

Ρουλεμάν υψηλής ακριβείας
Tarkkuuslaakerit
Rolamentos de alta precisão
Højpræcisionslejer
Precisionslager
Høypresisjonslager

	€	d	D	B	min		€	d	D	B	min
71905 CDGA/P4A	***	25	42	9		71936 ACDGA/P4A	***	180	250	33	
71906 ACDGA/P4A	***	30	47	9		71936 CDGA/P4A	***	180	250	33	
71906 CDGA/P4A	***	30	47	9							
71907 ACDGA/P4A	***	35	55	10							
71907 CDGA/P4A	***	35	55	10							
71908 ACDGA/P4A	***	40	62	12		7200 CDGA/P4A	***	10	30	9	
71908 CDGA/P4A	***	40	62	12		7201 ACDGA/P4A	***	12	32	10	
71909 ACDGA/P4A	***	45	68	12		7201 CDGA/P4A	***	12	32	10	
71909 CDGA/P4A	***	45	68	12		7202 ACDGA/P4A	***	15	35	11	
71910 ACDGA/P4A	***	50	72	12		7202 CDGA/P4A	***	15	35	11	
71910 CDGA/P4A	***	50	72	12		7203 ACDGA/P4A	***	17	40	12	
71911 ACDGA/P4A	***	55	80	13		7203 CDGA/P4A	***	17	40	12	
71911 CDGA/P4A	***	55	80	13		7204 ACDGA/P4A	***	20	47	14	
71912 ACDGA/P4A	***	60	85	13		7204 CDGA/P4A	***	20	47	14	
71912 CDGA/P4A	***	60	85	13		7205 ACDGA/P4A	***	25	52	15	
71913 ACDGA/P4A	***	65	90	13		7205 CDGA/P4A	***	25	52	15	
71913 CDGA/P4A	***	65	90	13		7206 ACDGA/P4A	***	30	62	16	
71914 ACDGA/P4A	***	70	100	16		7206 CDGA/P4A	***	30	62	16	
71914 CDGA/P4A	***	70	100	16		7207 ACDGA/P4A	***	35	72	17	
71915 ACDGA/P4A	***	75	105	16		7207 CDGA/P4A	***	35	72	17	
71915 CDGA/P4A	***	75	105	16		7208 ACDGA/P4A	***	40	80	18	
71916 ACDGA/P4A	***	80	110	16		7208 CDGA/P4A	***	40	80	18	
71916 CDGA/P4A	***	80	110	16		7209 ACDGA/P4A	***	45	85	19	
71917 ACDGA/P4A	***	85	120	18		7209 CDGA/P4A	***	45	85	19	
71917 CDGA/P4A	***	85	120	18		7210 ACDGA/P4A	***	50	90	20	
71918 ACDGA/P4A	***	90	125	18		7210 CDGA/P4A	***	50	90	20	
71918 CDGA/P4A	***	90	125	18		7211 ACDGA/P4A	***	55	100	21	
71919 ACDGA/P4A	***	95	130	18		7211 CDGA/P4A	***	55	100	21	
71919 CDGA/P4A	***	95	130	18		7212 ACDGA/P4A	***	60	110	22	
71920 ACDGA/P4A	***	100	140	20		7212 CDGA/P4A	***	60	110	22	
71920 CDGA/P4A	***	100	140	20		7213 ACDGA/P4A	***	65	120	23	
71922 ACDGA/P4A	***	110	150	20		7213 CDGA/P4A	***	65	120	23	
71922 CDGA/P4A	***	110	150	20		7214 ACDGA/P4A	***	70	125	24	
71924 ACDGA/P4A	***	120	165	22		7214 CDGA/P4A	***	70	125	24	
71924 CDGA/P4A	***	120	165	22		7215 ACDGA/P4A	***	75	130	25	
71926 ACDGA/P4A	***	130	180	24		7215 CDGA/P4A	***	75	130	25	
71926 CDGA/P4A	***	130	180	24		7216 ACDGA/P4A	***	80	140	26	
71928 ACDGA/P4A	***	140	190	24		7216 CDGA/P4A	***	80	140	26	
71928 CDGA/P4A	***	140	190	24		7217 ACDGA/P4A	***	85	150	28	
71930 ACDGA/P4A	***	150	210	28		7217 CDGA/P4A	***	85	150	28	
71930 CDGA/P4A	***	150	210	28		7218 ACDGA/P4A	***	90	160	30	
71932 ACDGA/P4A	***	160	220	28		7218 CDGA/P4A	***	90	160	30	
71932 CDGA/P4A	***	160	220	28		7219 ACDGA/P4A	***	95	170	32	
71934 ACDGA/P4A	***	170	230	28		7219 CDGA/P4A	***	95	170	32	
71934 CDGA/P4A	***	170	230	28		7220 ACDGA/P4A	***	100	180	34	

* = Matchable

Ρουλεμάν υψηλής ακριβείας
 Tarkkuuslaakerit
 Rolamentos de alta precisão
 Højpræcisionslejer
 Precisionslager
 Høypresisjonslager

High Precision Bearings
 Hochgenauigkeitslager
 Roulements de haute précision
 Cuscinetti di precisione
 Rodamientos de alta precisión
 Høge-precisielagers

	€	d	D	B	min		€	d	D	B	min
7220 CDGA/P4A	***	100	180	34							
7222 ACDGA/P4A	***	110	200	38							
7222 CDGA/P4A	***	110	200	38							
7224 ACDGA/P4A	***	120	215	40							
7224 CDGA/P4A	***	120	215	40							

* = Matchable



High Precision Bearings
Hochgenauigkeitslager
Roulements de haute précision
Cuscinetti di precisione
Rodamientos de alta precisión
Høge-precisielagers

Ρουλεμάν υψηλής ακριβείας
Tarkkuuslaakerit
Rolamentos de alta precisão
Højpræcisionslejer
Precisionslager
Høypresisjonslager

	€	d	D	H	min		€	d	D	H	min
* BSA 201 CGA	***	12	32	0,04		NNU 4920 B/SPW33	***	100	140	40	
BSA 201 CGB	***	12	32	0,04		NNU 4920 BK/SPW33	***	100	140	40	
* BSA 202 CGA	***	15	35	0,05		NNU 4921 BK/SPW33	***	105	145	40	
* BSA 204 CGA	***	20	47	0,11		NNU 4922 B/SPW33	***	110	150	40	
* BSA 205 CGA	***	25	52	0,15		NNU 4922 BK/SPW33	***	110	150	40	
* BSA 206 CGA	***	30	62	0,22		NNU 4924 B/SPW33	***	120	165	45	
* BSA 305 CGA	***	25	62	0,27		NNU 4924 BK/SPW33	***	120	165	45	
* BSA 308 CGA	***	40	90	0,72		NNU 4926 B/SPW33	***	130	180	50	
						NNU 4926 BK/SPW33	***	130	180	50	
						NNU 4928 B/SPW33	***	140	190	50	
* BSD 2047 CGA	***	20	47	15	10	NNU 4928 BK/SPW33	***	140	190	50	
* BSD 2562 CGA	***	25	62	15	5	NNU 4930 B/SPW33	***	150	210	60	
* BSD 3062 CGA	***	30	62	15	5	NNU 4930 BK/SPW33	***	150	210	60	
* BSD 3572 CGA	***	35	72	15	5	NNU 4932 B/SPW33	***	160	220	60	
* BSD 4072 CGA	***	40	72	15	5	NNU 4932 BK/SPW33	***	160	220	60	
* BSD 4090 CGA	***	40	90	20	5	NNU 4934 B/SPW33	***	170	230	60	
BSD 45100 CGA	***	45	100	20	5	NNU 4934 BK/SPW33	***	170	230	60	
BSD 50100 CGA	***	50	100	20	5	NNU 4936 B/SPW33	***	180	250	69	
						NNU 4936 BK/SPW33	***	180	250	69	
						NNU 4938 B/SPW33	***	190	260	69	
						NNU 4938 BK/SPW33	***	190	260	69	

* = Matchable

Ευρετήριο

Index
Índice
Indeks
Index
Indeks

Index
Index
Index
Índice
Index

10	34	60	21
112	36	618	28
12	34	619	29
13	34	62	23
160	28	63	25
161	28	630	30
17262(00)	84	64	27
17263(00)	84	70 .. P4A	178
213	64	718 .. P4A	178
22	35	719 .. P4A	178
222	64	72	38
223	65	72 .. P4A	179
23	36	73	39
230	66	74	40
231	66	811	156
232	67	812	156
239	67	AH	134
240	67	AHX	134
241	68	AOH	134
292	80	AS	154
293	80	ASNH	114
294	80	AXK	154
302	46	BA	75
303	46	BS2-2CS	68
3057 (00) C-2Z	162	BSA	181
3058 (00) C-2Z	162	BSD	181
313	46	C 22	70
32	40	C 23	70
320	47	C 30	71
322	47	C 32	71
323	47	C 40	71
329	47	C 69	71
33	41	E2	30
330	48	ECL	84
331	48	ECL..B	84
332	48	ECY	84
3612.. R	32	ETS	137
42	31	FNL .. A	112
43	31	FNL .. B	113
511	75	FRB	116
512	75	FSNL	112
513	75	FY	108
514	76	FY .. FM	91
522	77	FY .. FM	94
523	77	FY .. TF	91
524	77	FY .. TF	94
532	77	FY .. TR	91
533	77	FY .. TR	94

FY .. VA201	92	GE .. C	169
FY .. VA201	95	GE .. E	169
FY .. VA228	92	GE .. ES	169
FY .. VA228	95	GE .. TXA	170
FY .. WF	92	GE .. TXE	170
FY .. WF	95	GE .. TXG	170
FYC	92	GEG .. ES	169
FYC	95	GEH .. C	170
FYJ	97	GEH .. ES	169
FYJ	100	GEK .. ES	170
FYJ .. KF	96	GEM .. ES	169
FYJ .. KF	99	GEZ .. ES	170
FYK .. TF	89	GS 811	157
FYK .. TF	103	GX .. F	171
FYK .. TR	89	H 2(00)	132
FYK .. TR	103	H 23(00)	132
FYKC	89	H 3 E	71
FYKC	103	H 3(00)	132
FYL	90	H 30(00)	132
FYL	104	H 31 L	71
FYL .. VE495	90	H 31(00)	132
FYL .. VE495	104	HK	143
FYTB .. FM	92	HM	137
FYTB .. FM	95	HYBRID	31
FYTB .. TF	93	INSOCOAT	32
FYTB .. TF	96	IR	149
FYTB .. TR	93	ISTRB	50
FYTB .. TR	96	K	143
FYTB .. WF	93	K 811	156
FYTB .. WF	96	KM	136
FYTBK .. TF	89	KMK	135
FYTBK .. TF	103	KML	136
FYTBK .. TR	89	KMT	137
FYTBK .. TR	103	KMTA	137
FYTBKC	89	KR	164
FYTBKC	103	KRE	165
FYTF	93	KRV	165
FYTF	96	LS	154
FYTJ	93	MB	138
FYTJ	96	MBL	138
FYTJ .. KF	96	MS	138
FYTJ .. KF	99	N 2	55
FYTL	90	N 3	55
FYTL	104	NA 22	163
FYTL .. VE495	90	NA 48	147
FYTL .. VE495	104	NA 49	147
G	152	NA 69	148
GAC .. F	171	NATR	163

NATV	164	SA .. ES	172
NCF 29	62	SA .. TXE	171
NCF 30	62	SAKAC	173
NJ 2	55	SAKB	173
NJ 20	56	SAL .. E	173
NJ 22	56	SAL .. ES	173
NJ 23	56	SALKAC .. M	174
NJ 3	56	SALKB .. F	173
NJ 4	56	SC	172
NK	144	SCF	172
NKI	146	SI	172
NKIA	150	SIA	172
NKIB	150	SIKAC	172
NKIS	146	SIKB	173
NKS	145	SIL .. E	174
NKX	151	SIL .. ES	174
NKXR	152	SILKAC .. M	173
NNF 50	62	SILKB .. F	173
NNU 49	181	SIQG	172
NU 10	59	SIR	172
NU 2	57	SNL	112
NU 22	60	SNL 31	112
NU 23	60	SNLN 30	112
NU 3	58	SONL	112
NU 4	59	SSNLD	112
NUKR	165	STO	163
NUKRE	165	SY	108
NUP 2	61	SY .. FM	87
NUP 22	61	SY .. FM	90
NUP 23	61	SY .. TF	87
NUP 3	61	SY .. TF	90
NUTR	164	SY .. TR	87
NX	151	SY .. TR	90
P	87	SY .. VA201	88
P	106	SY .. VA201	91
PDN	112	SY .. VA228	88
PNA	149	SY .. VA228	91
QJ 2	42	SY .. WF	90
QJ 3	43	SY .. WF	93
RIS	84	SYF .. FM	89
RNA 22	163	SYF .. FM	92
RNA 48	145	SYF .. TF	90
RNA 49	145	SYF .. TF	93
RNA 69	145	SYFJ	90
RPNA	148	SYFJ	93
RSTO	163	SYFL	87
SA .. C	173	SYFL	101
SA .. E	172	SYFL .. VE495	87

Index
Index
Index
Índice
Índice
Index

Ευρετήριο
Index
Índice
Indeks
Index
Indeks

SYFL .. VE495	101
SYJ .. KF	96
SYJ .. KF	99
SYJ .. TF	88
SYJ .. TF	91
SYK .. TF	88
SYK .. TF	102
SYK .. TR	88
SYK .. TR	102
SYKC	88
SYKC	102
SYL	88
SYL	102
SYL .. VE495	88
SYL .. VE495	102
SYNT .. F	108
SYNT .. FTS	108
SYNT .. L	108
SYNT .. LTS	108
TS	114
TSN .. A	114
TSN .. C	115
TSN .. L	115
TSN .. S	115
TU .. FM	95
TU .. FM	98
TU .. TF	95
TU .. TF	98
TUJ	95
TUJ	98
TUL	91
TUL	105
TUL .. VE495	91
TUL .. VE495	105
U 2	78
U 3	78
W 60..	32
W 62..	32
W 63..	32
WS 811	157
YAR 2	83
YAT 2	83
YEL 2	83
YET 2	83
YSA 2	84
Z	137

